

UTAH DIVISION OF WATER QUALITY
CLASS III AREA PERMIT
UNDERGROUND INJECTION CONTROL (UIC) PROGRAM

UIC Permit Number: UTU-37-AP-5D5F693

Lisbon Valley Mine
San Juan County, Utah

Permit Issued to:

Lisbon Valley Mining Company, L.L.C.

June, 2022

This page intentionally left blank.

Table of Contents

PART I. AUTHORIZATION TO CONSTRUCT AND INJECT	1
PART II. GENERAL PERMIT CONDITIONS.....	4
A. EFFECT OF PERMIT	4
B. SEVERABILITY	4
C. CONFIDENTIALITY	4
D. CONDITIONS APPLICABLE TO ALL UIC PERMITS (40 CFR 144.51).....	5
1. Duty to Comply (40 CFR 144.51(a)).....	5
2. Duty to Reapply (40 CFR 144.51(b)).....	5
3. Need to Halt or Reduce Activity Not a Defense (40 CFR 144.51(c))	5
4. Duty to Mitigate (40 CFR 144.51(d)).....	5
5. Proper Operation and Maintenance (40 CFR 144.51(e)).....	5
6. Permit Actions	6
7. Property Rights (40 CFR 144.51(g))	9
8. Duty to Provide Information (40 CFR 144.51(h)).....	9
9. Inspection and Entry (40 CFR 144.51(i))	9
10. Monitoring and Records (40 CFR 144.51(j))	10
11. Signatory Requirements (40 CFR 144.51(k)).....	10
12. Reporting Requirements (40 CFR 144.51(l))	12
13. Requirements Prior to Commencing Injection (40 CFR 144.51(m))	14
14. Notification Prior to Conversion or Abandonment. (40 CFR144.51(n)).....	14
15. Plugging and Abandonment Requirements. (40 CFR 144.51(o)).....	14
16. Plugging and Abandonment Report. (40 CFR 144.51(p)).....	14
17. Duty to Establish and Maintain Mechanical Integrity. (40 CFR 144.51(q)).....	15
PART III. SPECIFIC PERMIT CONDITIONS	16
A. DURATION OF PERMIT	16
B. COMPLIANCE SCHEDULE	16
1. Construction Plan.....	16
2. Operating Plan	16
3. Monitoring, Recording and Reporting Plan.....	16
4. Plugging and Abandonment Plan.....	17

5. Installation of Continuous Monitoring System.....	17
C. CORRECTIVE ACTION.....	17
D. CONSTRUCTION REQUIREMENTS.....	18
1. Class III Injection Well Construction Standards	18
2. Construction Plan.....	18
3. Changes to the Construction Plan.....	18
4. Casing and Cement	18
5. Tubing / Packer.....	19
6. Logging and Testing	19
7. Injection Zone Characterization.....	20
8. Well Stimulation Program	20
9. Monitoring Wells.....	20
10. Additional Construction Requirements.....	20
E. REQUIREMENTS PRIOR TO IN-SITU COPPER RECOVERY	21
1. Aquifer Exemption for USDWs and Aquifer Restoration Plan.....	21
2. Well Completion Report.....	21
3. Director’s Approval to Commence In-situ copper recovery.....	22
F. OPERATING REQUIREMENTS.....	22
1. Class III Injection Well Operation Standards	22
2. Operating Plan	22
3. Maximum Allowable Surface Injection Pressure (MASIP)	22
4. Borehole – Casing Annulus Injection Prohibited	22
5. Additional Operating Requirements	23
G. MONITORING AND RECORDING REQUIREMENTS	24
1. Class III Injection Well Monitoring and Recording Standards	24
2. Utah UIC Quality Assurance Project Plan (QAPP).....	24
3. Monitoring, Recording and Reporting Plan.....	24
4. Monitoring Equipment and Methods	24
5. Injectate Characterization	24
6. Injection Pressure, Injection Rate, and Injection Volume	25
7. Mechanical Integrity Test (MIT)	25
8. Injection Zone Fluid Level.....	25
9. Manifold Monitoring	25
10. Additional Monitoring and Recording Requirements.....	25

H. REPORTING REQUIREMENTS	25
1. Quarterly Monitoring Reports.....	25
2. Endangering Noncompliance Reporting.....	26
3. Planned Changes	27
4. Anticipated Noncompliance.....	27
5. Permit Transfers.....	27
6. Compliance Schedule Reporting.....	27
7. Mechanical Integrity Reporting	27
8. Plugging and Abandonment (“As-Plugged”) Report.....	27
9. Additional Reporting Requirements	28
I. MECHANICAL INTEGRITY	28
1. Class III Injection Well Mechanical Integrity Standards.....	28
2. Mechanical Integrity Testing (MIT) Methods	28
3. Mechanical Integrity Demonstration Plan	30
4. Mechanical Integrity Demonstration Frequency	30
5. Prohibition Without Demonstration.....	30
6. Loss of Mechanical Integrity	30
7. Mechanical Integrity Demonstration Requests.....	31
8. Mechanical Integrity Demonstration Inspections	31
9. Additional MIT Requirements	31
J. GROUNDWATER RESTORATION REQUIREMENTS	32
1. Requirement for Groundwater Restoration Plan.....	32
K. PLUGGING AND ABANDONMENT REQUIREMENTS	32
1. Requirement for Plugging and Abandonment Plan	32
2. Notice of Plugging and Abandonment.....	32
3. Emergency Well Conversion or Plugging and Abandonment.....	33
4. Plugging and Abandonment.....	33
5. Inactive or Temporarily Plugged Wells.....	33
L. FINANCIAL RESPONSIBILITY	34
1. Demonstration of Financial Responsibility	34
2. Renewal of Financial Responsibility	34
3. Insolvency Financial Responsibility	34
M. ADDITIONAL CONDITIONS (40 CFR 144.52)	34
N. ATTACHMENTS	35

- Attachment A - General Location Map of the Lisbon Valley Mine, San Juan County.
- Attachment B - Map of the UIC Area of Review including the Project Area
- Attachment C - Corrective Action Plan for Artificial Penetrations into Injection Zone within Area of Review
- Attachment D - Injection Well Construction Plan with Injection Well Construction Details
- Attachment E - Injection Well Operating Plan and Procedures
- Attachment F - Monitoring, Recording, and Reporting Plan
- Attachment G - Contingency Plan for Well Shut-ins or Well Failures
- Attachment H - Groundwater Restoration Plan
- Attachment I - Plugging and Abandonment Plan
- Attachment J - Financial Responsibility
- Attachment K - Expected Changes Due to Injection
- Attachment L - Mechanical Integrity Demonstration Protocols
- Attachment M - Aquifer Exemption Request

PART I. AUTHORIZATION TO CONSTRUCT AND INJECT

Pursuant to the Utah Underground Injection Control (UIC) Program Regulations codified in the Utah Administrative Code (UAC) R317-7,

Lisbon Valley Mining Company, LLC
(Hereafter referred to as Lisbon Valley)
PO Box 400
Moab, Utah 84532

Lisbon Valley Mining Company (Lisbon Valley) is hereby authorized to construct and operate Class III in-situ copper recovery injection wells in south central San Juan County, Utah to extract copper from the mineralized ore within the Burro Canyon Aquifer which includes the Dakota and Burro Canyon Formations. A general location map is included as Attachment A.

The legal description of the area to be included in the UIC area permit follows:

Township 31 South, Range 26 East, SLB&M

Section 4: All
Section 5: All
Section 6: All
Section 7: All
Section 8: All
Section 9: All
Section 10: All
Section 11: All
Section 14: All
Section 15: All
Section 16: All
Section 17: All

Township 30 South, Range 26 East, SLB&M

Section 31: All
Section 32: All

Township 30 South, Range 25 East, SLB&M

Section 36: All

Township 31 South, Range 25 East, SLB&M

Section 1: All

Containing 4803 acres
San Juan Counties, Utah

A map showing the area of review including the existing and proposed Class III in-situ copper recovery wells and the project area is included as Attachment B.

Whereas the Burro Canyon Aquifer must be exempted as an Underground Source of Drinking Water (USDW) according to UAC R317-7-4 and Title 40 of the Code of Federal Regulations (40 CFR) 144.7 and 146.4 within the permitted area before this permit becomes effective, the conditions in this permit are designed to ensure protection of the Navajo Aquifer and any USDWs that may be identified in the future.

Injection is explicitly limited to the Burro Canyon Aquifer, including the Dakota and Burro Canyon Formations, in the area of the facility from the top of the formation in contact with the Mancos Shale Formation or 100 ft below ground surface whichever is greater, to the depth where it contacts the Morrison Formation, upon the express conditions that the Lisbon Valley meets the conditions set forth herein. Injection into new wells shall not commence until the operator has fulfilled all applicable conditions of this permit and has received written authorization from the Director of the Division of Water Quality (hereafter referred to as ‘the Director’) to inject.

It is typical of copper recovery mining operations to use production wells and injection wells interchangeably for at least some period of time. Therefore, this permit will cover both production wells and injection wells.

All references to UAC R315-2-3, UAC R317-7, and to 40 CFR are to all regulations that are in effect on the date this permit becomes effective. The following are incorporated as enforceable attachments to this permit:

- Attachment A - General Location Map of the Lisbon Valley Mine, San Juan County.
- Attachment B - Map of the UIC Area of Review including the Class III In-situ copper recovery Injection Wells and the Project Area
- Attachment C - Corrective Action Plan for Artificial Penetrations into Injection Zone within Area of Review
- Attachment D - Injection Well Construction Plan with Injection Well Construction Details
- Attachment E - Injection Well Operating Plan and Procedures
- Attachment F - Monitoring, Recording, and Reporting Plan
- Attachment G - Contingency Plan for Well Shut-ins or Well Failures
- Attachment H - Groundwater Restoration Plan
- Attachment I - Plugging and Abandonment Plan
- Attachment J - Financial Responsibility
- Attachment K - Expected Changes Due to Injection
- Attachment L - Mechanical Integrity Demonstration Protocols
- Attachment M - Aquifer Exemption Request

This permit is based upon representations made by the Lisbon Valley and other information contained in the administrative record. **It is the responsibility of the Lisbon Valley to read and understand all provisions of this permit.**

Any person who violates the Utah Water Quality Act (UWQA), or any permit, rule, or order adopted under it, is subject to the provisions of section UCA 19-5-115 of the UWQA governing violations.

This permit shall become effective July 6, 2022.

This permit and the authorization to inject shall be issued for 5 years as described in Part III A – Duration of Permit of this permit unless terminated prior to the expiration date or renewed.



John Mackey, P.E.
Director
Utah Division of Water Quality

DWQ-2020-020464

PART II. GENERAL PERMIT CONDITIONS

A. EFFECT OF PERMIT

The permittee is allowed to engage in underground injection in accordance with the conditions of this permit. Lisbon Valley, authorized by this permit, shall not construct, operate, maintain, convert, plug, abandon or conduct any other injection activity in a manner that allows the movement of fluid containing any contaminant into underground sources of drinking water (USDW), if the presence of that contaminant may cause a violation of any primary drinking water standard under the Utah Public Drinking Water Administrative Rules, UAC R309-200 and 40 CFR Part 141, or may otherwise adversely affect the health of persons. Any underground injection activity not specifically authorized in this permit is prohibited unless otherwise authorized-by-rule or by another UIC permit. Compliance with this permit does not constitute a defense to any action brought under the Utah Water Quality Act (UWQA) Title 19, Chapter 5 Utah Code Annotated 1953, or any other common or statutory law or regulation. Issuance of this permit does not authorize any injury to persons or property, any invasion of other private rights, or any infringement of State or local law or regulations. Nothing in this permit shall be construed to relieve Lisbon Valley of any duties under applicable regulations.

B. SEVERABILITY

The provisions of this permit are severable. If any provision of this permit or the application of any provision of this permit to any circumstance is held to be invalid, the application of such provision to other circumstances and the remainder of this permit shall not be affected thereby.

C. CONFIDENTIALITY

In accordance with Utah Code 19-1-306 (Records of the Department of Environmental Quality), Utah Code 63G-2-309 (Confidentiality Claims), and Utah Code 19-5-113 (DWQ Records and Reports Required by Owners/Operators) any information deemed by Lisbon Valley to be entitled to trade secret protection submitted to the DWQ pursuant to this permit may be claimed as confidential by the submitter. Any such claim must be asserted at the time of submission by stamping the words "Confidential Business Information" on each page containing such information. If no claim is made at the time of submission, the DWQ may make the information available to the public without further notice. Claims of confidentiality may be denied by the DWQ according to the procedures detailed in Utah Code 63G-2 and the federal Freedom of Information Act (FOIA). Claims of confidentiality for the following information will be denied as per UAC R317-7-9.7:

1. The name and address of the permittee.
2. Information that deals with the existence, absence or level of contaminants in drinking water.

D. CONDITIONS APPLICABLE TO ALL UIC PERMITS (40 CFR 144.51)¹

The following conditions are required for all Class III permits. Specific requirements for implementing these conditions are included in Part III of this permit, as necessary.

1. Duty to Comply (40 CFR 144.51(a))

Lisbon Valley shall comply with all conditions of this permit. Any permit noncompliance constitutes a violation of the Safe Drinking Water Act and the UWQA and is grounds for enforcement action, permit termination, revocation and re-issuance, modification; or for denial of a permit renewal application; except that Lisbon Valley need not comply with the provisions of this permit to the extent and for the duration such noncompliance is authorized in an emergency permit issued in accordance with UAC R317-7-8 (40 CFR 144.34). Such noncompliance may also be grounds for enforcement action under the Utah Solid and Hazardous Waste Act (USHWA), Title 19, Chapter 6, Utah Code Annotated 1979.

2. Duty to Reapply (40 CFR 144.51(b))

If the Lisbon Valley wishes to continue an activity regulated by this permit after the expiration date of this permit, the Lisbon Valley must apply for and obtain a new permit. Lisbon Valley shall submit a complete permit renewal application at least 180 days before this permit expires. Class III well permits are subject to renewal by the Director at least once every five years to determine whether it should be modified, revoked and reissued, or terminated.

3. Need to Halt or Reduce Activity Not a Defense (40 CFR 144.51(c))

It shall not be a defense for Lisbon Valley in an enforcement action that it would have been necessary to halt or reduce the permitted activity in order to maintain compliance with the conditions of this permit.

4. Duty to Mitigate (40 CFR 144.51(d))

Lisbon Valley shall take all reasonable steps to minimize or correct any adverse impact on the environment resulting from noncompliance with this permit.

5. Proper Operation and Maintenance (40 CFR 144.51(e))

Lisbon Valley shall at all times properly operate and maintain all facilities and systems of treatment and control (and related appurtenances) which are installed or used by Lisbon Valley to achieve compliance with the conditions of this permit. Proper operation and maintenance includes effective performance, adequate funding, adequate operator staffing and training, and adequate laboratory and process controls, including appropriate quality assurance procedures. This provision requires the operation of back-up or auxiliary facilities or similar systems only when necessary to achieve compliance with the conditions of this permit.

¹ Parenthetical references to the Code of Federal Regulations (CFR) and / or the Utah Administrative Code (UAC) for the UIC Program indicate the requirement for inclusion in the permit.

6. Permit Actions

(40 CFR 144.51(f), 40 CFR 124.5, 40 CFR 144.38, 40 CFR 144.39, 40 CFR 144.40, 40 CFR 144.41)

This permit may be modified, revoked and reissued, or terminated either at the request of any interested person (including Lisbon Valley) or upon the Director's initiative. However, permits may only be modified, revoked and reissued, or terminated for the reasons specified in sections a) and b) below. All requests shall be in writing and shall contain facts or reasons supporting the request. The filing of a request for a permit modification, revocation and re-issuance, or termination on the part of Lisbon Valley, does not stay any permit condition. This permit may be transferred according to the procedures given in section d).

a) Modify or Revoke and Re-Issue Permits

When the Director receives any information (for example, inspects the facility, receives information submitted by Lisbon Valley as required in the permit, receives a request for modification or revocation and reissuance, or conducts a review of the permit file), the Director may determine whether or not one or more of the causes listed in paragraphs (1) and (2) of this section for modification or revocation and reissuance or both exist. If cause exists, the Director may modify or revoke and reissue the permit accordingly, subject to the limitations of paragraph (3) of this section, and may request an updated application if necessary. When a permit is modified, only the conditions subject to modification are reopened. If a permit is revoked and reissued, the entire permit is reopened and subject to revision and the permit is reissued for a new term. If cause does not exist under this section a) or under section c) for minor modifications, the Director shall not modify or revoke and reissue the permit. If a permit modification satisfies the criteria for minor modifications in section c) the permit may be modified without a draft permit or public review. Otherwise, a draft permit must be prepared and other procedures in 40 CFR 124, incorporated by reference into the Utah UIC Program rules (hereafter referred to as '40 CFR 124'), must be followed.

- (1) Causes for modification. For Class III wells the following may be causes for revocation and reissuance as well as modification.
 - i. Alterations. There are material and substantial alterations or additions to the permitted facility or activity which occurred after permit issuance which justify the application of permit conditions that are different or absent in the existing permit.
 - ii. Information. The Director has received information. For UIC area permits, this cause shall include any information indicating that cumulative effects on the environment are unacceptable.
 - iii. New regulations. The standards or regulations on which the permit was based have been changed by promulgation of new or amended standards or regulations or by judicial decision after the permit was issued.

iv. Compliance schedules. The Director determines good cause exists for modification of a compliance schedule, such as an act of God, strike, flood, or materials shortage or other events over which Lisbon Valley has little or no control and for which there is no reasonably available remedy. See also paragraph (3) under section c) – Minor Modification of Permit).

(2) Causes for modification or revocation and reissuance. The following are causes to modify or, alternatively, revoke and reissue a permit:

i. Cause exists for termination under section b), and the Director determines that modification or revocation and reissuance is appropriate.

ii. The Director has received notification (as required in the permit, see paragraph (4) under section c) – Minor Modification of Permit) of a proposed transfer of the permit. A permit also may be modified to reflect a transfer after the effective date of an automatic transfer (see paragraph (2) of section d) – Transfer of Permit) but will not be revoked and reissued after the effective date of the transfer except upon the request of the new Lisbon Valley.

iii. A determination that the waste being injected is a hazardous waste as defined in 40 CFR 261.3 either because the definition has been revised, or because a previous determination has been changed.

(3) Facility siting. Suitability of the facility location will not be considered at the time of permit modification or revocation and reissuance unless new information or standards indicate that a threat to human health or the environment exists which was unknown at the time of permit issuance.

b) Termination of Permit

(1) The Director may terminate a permit during its term, or deny a permit renewal application for the following causes:

i. Noncompliance by the Lisbon Valley with any condition of the permit;

ii. The Lisbon Valley's failure in the application or during the permit issuance process to disclose fully all relevant facts, or the Lisbon Valley's misrepresentation of any relevant facts at any time; or

iii. A determination that the permitted activity endangers human health or the environment and can only be regulated to acceptable levels by permit modification or termination;

(2) The Director shall follow the applicable procedures in 40 CFR 124 in terminating any permit under this section.

c) Minor Modification of Permit

Upon the consent of the Lisbon Valley, the Director may modify a permit to make the corrections or allowances for changes in the permitted activity listed

in this section, without following the procedures of 40 CFR 124. Any permit modification not processed as a minor modification under this section must be made for cause and with 40 CFR 124 draft permit and public notice as required in section a). Minor modifications may only:

- (1) Correct typographical errors;
- (2) Require more frequent monitoring or reporting by the Lisbon Valley;
- (3) Change an interim compliance date in a schedule of compliance, provided the new date is not more than 120 days after the date specified in the existing permit and does not interfere with attainment of the final compliance date requirement; or
- (4) Allow for a change in ownership or operational control of a facility where the Director determines that no other change in the permit is necessary, provided that a written agreement containing a specific date for transfer of permit responsibility, coverage, and liability between the current and new Lisbon Valley has been submitted to the Director.
- (5) Change quantities or types of fluids injected which are within the capacity of the facility as permitted and, in the judgment of the Director, would not interfere with the operation of the facility or its ability to meet conditions described in the permit and would not change its classification.
- (6) Change construction requirements approved by the Director pursuant to 40 CFR 144.52(a)(1) (establishing UIC permit conditions), provided that any such alteration shall comply with the requirements of 40 CFR 144 and 40 CFR 146.
- (7) Amend a plugging and abandonment plan which has been updated.

d) Transfer of Permit

- (1) Transfers by Modification. Except as provided in paragraph (2) of this section, a permit may be transferred by Lisbon Valley to a new owner or operator only if the permit has been modified or revoked and reissued (under paragraph (2)(ii) under section a)), or a minor modification made (under paragraph (4) of section c)) to identify the new owner and incorporate such other requirements as may be necessary under the Safe Drinking Water Act.
- (2) Automatic Transfers. As an alternative to transfers under paragraph (1) of this section, any UIC permit for a well not injecting hazardous waste or injecting carbon dioxide for geologic sequestration may be automatically transferred to a new owner if:
 - i. The current owner notifies the Director at least 30 days in advance of the proposed transfer date referred to in paragraph (2)(ii) of this section;
 - ii. The notice includes a written agreement between the existing and new owners containing a specific date for transfer of permit responsibility,

coverage, and liability between them, and the notice demonstrates that the following financial responsibility requirements of 40 CFR 144.52(a)(7) will be met by the new owner:

The owner, including the transferor of a permit, is required to demonstrate and maintain financial responsibility and resources to close, plug, and abandon the underground injection operation in a manner prescribed by the Director until:

- (A) The well has been plugged and abandoned in accordance with an approved plugging and abandonment plan and submitted a plugging and abandonment report; or
- (B) The well has been converted; or
- (C) The transferor of a permit has received notice from the Director that the owner or operator receiving transfer of the permit, the new Lisbon Valley, has demonstrated financial responsibility for the well.

The owner shall show evidence of such financial responsibility to the Director by the submission of a surety bond, or other adequate assurance, such as a financial statement or other materials acceptable to the Director.

- iii. The Director does not notify the existing owner and the proposed new owner of intent to modify or revoke and reissue the permit. A modification under this paragraph may also be a minor modification under section c) – Minor Modification of Permit. If this notice is not received, the transfer is effective on the date specified in the agreement mentioned in paragraph (2)(ii) of this section.

7. Property Rights (40 CFR 144.51(g))

This permit does not convey any property rights of any sort, or any exclusive privilege.

8. Duty to Provide Information (40 CFR 144.51(h))

Lisbon Valley shall furnish to the Director within a time specified, any information which the Director may request to determine whether cause exists for modifying, revoking and re-issuing, or terminating this permit, or to determine compliance with this permit. The Lisbon Valley shall also furnish to the Director upon request, copies of records required to be kept by this permit.

9. Inspection and Entry (40 CFR 144.51(i))

Lisbon Valley shall allow the Director, or an authorized representative, upon the presentation of credentials and other documents as may be required by the law, to:

- a) Enter upon the Lisbon Valley's premises where a regulated facility or activity is located or conducted, or where records must be kept under the conditions of this permit;
 - b) Have access to and copy, at reasonable times, any records that are kept under the conditions of this permit;
 - c) Inspect at reasonable times any facilities, equipment (including monitoring and control equipment), practices, or operations regulated or required under this permit; and
 - d) Sample or monitor at reasonable times, for the purposes of assuring permit compliance or as otherwise authorized by the SDWA and / or UWQA any substances or parameters at any location.
10. Monitoring and Records (40 CFR 144.51(j))
- a) Samples and measurements taken for the purpose of monitoring shall be representative of the monitored activity.
 - b) Lisbon Valley shall retain records of all monitoring information, including the following:
 - (1) Calibration and maintenance records and all original strip chart recordings for continuous monitoring instrumentation, copies of all reports required by this permit, and records of all data used to complete the application for this permit, for a period of at least 3 years from the date of the sample, measurement, report, or application. This period may be extended by request of the Director at any time; and
 - (2) The nature and composition of all injected fluids until three years after the completion of any plugging and abandonment as appropriate. The Director may require the owner or operator to deliver the records to the Director at the conclusion of the retention period.
 - c) Records of monitoring information shall include:
 - (1) The date, exact place, and time of sampling or measurements;
 - (2) The individual(s) who performed the sampling or measurements;
 - (3) The date(s) analyses were performed;
 - (4) The names of individual(s) who performed the analyses;
 - (5) The analytical techniques or methods used; and
 - (6) The results of such analyses.
11. Signatory Requirements (40 CFR 144.51(k))
- All reports or other information, submitted as required by this permit or requested by the Director, shall be signed and certified as follows:
- a) Applications. All permit applications shall be signed as follows:

-
- (1) For a corporation: by a responsible corporate officer. For the purpose of this section, a responsible corporate officer means:
 - i. A president, secretary, treasurer, or vice president of the corporation in charge of a principal business function, or any other person who performs similar policy- or decision-making functions for the corporation, or
 - ii. the manager of one or more manufacturing, production, or operating facilities employing more than 250 persons or having gross annual sales or expenditures exceeding \$25 million (in second-quarter 1980 dollars), if authority to sign documents has been assigned or delegated to the manager in accordance with corporate procedures.

Note:

The Division of Water Quality does not require specific assignments or delegations of authority to responsible corporate officers identified in 40 CFR 144.32(a)(1)(i). Therefore, the Division of Water Quality will presume that these responsible corporate officers have the requisite authority to sign permit applications unless the corporation has notified the Director to the contrary. Corporate procedures governing authority to sign permit applications may provide for assignment or delegation to applicable corporate positions under 40 CFR 144.32(a)(1)(ii) rather than to specific individuals.

- (2) For a partnership or sole proprietorship: by a general partner or the proprietor, respectively; or
 - (3) For a municipality, State, Federal, or other public agency: by either a principal executive officer or ranking elected official. For purposes of this section, a principal executive officer of a Federal agency includes: (i) The chief executive officer of the agency, or (ii) a senior executive officer having responsibility for the overall operations of a principal geographic unit of the agency (e.g., Regional Administrators of EPA).
- b) Reports. All reports required by permits and other information requested by the Director shall be signed by a person described in section a), or by a duly authorized representative of that person. A person is a duly authorized representative only if:
- (1) The authorization is made in writing by a person described in paragraph a) of this section;
 - (2) The authorization specifies either an individual or a position having responsibility for the overall operation of the regulated facility or activity, such as the position of plant manager, operator of a well or a well field, superintendent, or position of equivalent responsibility. (A duly authorized representative may thus be either a named individual or any individual occupying a named position); and
 - (3) The written authorization is submitted to the Director.

- c) Changes to authorization. If an authorization under section b) is no longer accurate because a different individual or position has responsibility for the overall operation of the facility, a new authorization satisfying the requirements of section b) must be submitted to the Director prior to or together with any reports, information, or applications to be signed by an authorized representative.
 - d) Certification. Any person signing a document under section a) or b) shall make the following certification:

“I CERTIFY UNDER PENALTY OF LAW THAT THIS DOCUMENT AND ALL ATTACHMENTS WERE PREPARED UNDER MY DIRECTION OR SUPERVISION IN ACCORDANCE WITH A SYSTEM DESIGNED TO ASSURE THAT QUALIFIED PERSONNEL PROPERLY GATHER AND EVALUATE THE INFORMATION SUBMITTED BASED ON MY INQUIRY OF THE PERSON OR PERSONS WHO MANAGE THE SYSTEM, OF THOSE PERSONS DIRECTLY RESPONSIBLE FOR GATHERING THE INFORMATION, THE INFORMATION SUBMITTED IS, TO THE BEST OF MY KNOWLEDGE AND BELIEF, TRUE, ACCURATE, AND COMPLETE. I AM AWARE THAT THERE ARE SIGNIFICANT PENALTIES FOR SUBMITTING FALSE INFORMATION, INCLUDING THE POSSIBILITY OF FINE AND IMPRISONMENT FOR KNOWING VIOLATIONS.”
12. Reporting Requirements (40 CFR 144.51(l))
- All requirements for reporting the following items are specified in Part III (H) of the permit.
- a) **Planned Changes**

Lisbon Valley shall give written notice to the Director, as soon as possible, of any planned physical alterations or additions to the UIC-permitted facility. Notification of planned changes on the part of Lisbon Valley does not stay any permit condition.
 - b) **Anticipated Noncompliance**

Lisbon Valley shall give advance notice to the Director of any planned changes in the permitted facility or activity that may result in noncompliance with permit requirements. Notification of anticipated noncompliance on the part of Lisbon Valley does not stay any permit condition.
 - c) **Permit Transfers**

This permit is not transferable to any person except in accordance with section d) of Permit Actions – Transfer of Permit. The Director may require modification or revocation and re-issuance of the permit to change the name of Lisbon Valley and incorporate such other requirements as may be necessary under the Safe Drinking Water Act and / or the UWQA.
 - d) **Monitoring**

All reporting requirements of monitoring results shall be reported at the intervals specified in Part III (H) of this permit.
-

e) Compliance Schedule

All reports of compliance or noncompliance with, or any progress reports on, interim and final requirements contained in any compliance schedule specified in Part III (B) of this permit shall be submitted no later than 30 days following each schedule date as specified in Part III (H) of this permit.

f) Endangering Noncompliance

Lisbon Valley shall report to the Director any noncompliance that may endanger health or the environment, as follows:

(1) Twenty-four Hour Reporting

Endangering noncompliance information shall be provided orally within 24 hours from the time Lisbon Valley becomes aware of the circumstances. Such reports shall include, but not be limited to, the following information:

- i. Any monitoring or other information that indicates any contaminant may cause an endangerment to a USDW, or
- ii. Any noncompliance with a permit condition, or malfunction of the injection system, which may cause fluid migration into or between USDWs.

(2) Five-day Reporting

A written submission shall be provided within five days of the time Lisbon Valley becomes aware of the circumstances of the endangering noncompliance. The written submission shall contain a description of the noncompliance and its cause, the period of noncompliance, including exact dates and times, and if the noncompliance has not been corrected, the anticipated time it is expected to continue; and steps taken or planned to reduce, eliminate, and prevent recurrence of the noncompliance.

g) Other Noncompliance

Lisbon Valley shall report all instances of noncompliance not reported under 12d) (Monitoring Reports), 12e) (Compliance Schedule Reports), or 12f) (Endangering Noncompliance Monitoring) of this section in the next Monitoring Report. The reports shall contain a description of the noncompliance and its cause, the period of noncompliance, including exact dates and times, and if the noncompliance has not been corrected, the anticipated time it is expected to continue; and steps taken or planned to reduce, eliminate, and prevent recurrence of the noncompliance.

h) Other Information

When Lisbon Valley becomes aware of a failure to submit any relevant facts in the permit application or submitted incorrect information in a permit application or in any report to the Director, Lisbon Valley shall submit such facts or information within 10 days after becoming aware of the failure to submit relevant facts.

13. Requirements Prior to Commencing Injection (40 CFR 144.51(m))

- a) For any new injection well authorized by individual permit, a new injection well may not commence injection until construction is complete, and
- (1) Lisbon Valley has submitted notice of completion of construction to the Director; and
 - (2) Either of the following:
 - i. The Director has inspected or otherwise reviewed the new injection well and finds it is in compliance with the conditions of the permit; or
 - ii. Lisbon Valley has not received notice from the Director of his or her intent to inspect or otherwise review the new injection well within 13 days of the date of the notice in section a), in which case prior inspection or review is waived and Lisbon Valley may commence injection. The Director shall include in his notice a reasonable time period in which he shall inspect the well.
- b) For new injection wells authorized by an area permit under UAC R317-7-7 (40 CFR 144.33), all requirements prior to commencing injection are specified in Part III (E) of the permit.

14. Notification Prior to Conversion or Abandonment. (40 CFR 144.51(n))

Lisbon Valley shall notify the Director at such times as the permit requires before conversion or abandonment of the well or in the case of area permits before closure of the projects.

15. Plugging and Abandonment Requirements. (40 CFR 144.51(o))

A Class III permit shall include, conditions for developing a plugging and abandonment plan that meets the applicable requirements of UAC R317-7 to ensure that plugging and abandonment of the well will not allow the movement of fluids into or between USDWs. If the plan meets the plugging and abandonment requirements of UAC R317-7, the Director shall incorporate it into the permit as a permit condition. Where the review of the plan submitted in the permit application indicates the plan is inadequate, the Director may require the applicant to revise the plan, prescribe conditions meeting the requirements of this paragraph, or deny the permit. For purposes of this paragraph, temporary or intermittent cessation of injection operations is not abandonment. All requirements for implementing the approved plugging and abandonment plan are specified in Part III (J) of this permit.

16. Plugging and Abandonment Report. (40 CFR 144.51(p))

All requirements for submitting a plugging and abandonment report are specified in Part III (H) of this permit.

17. Duty to Establish and Maintain Mechanical Integrity. (40 CFR 144.51(q))
- a) The owner or operator of a Class III well shall establish mechanical integrity prior to commencing injection or on a schedule determined by the Director, and thereafter maintain mechanical integrity as defined in 40 CFR 146.8.
 - b) When the Director determines that a Class III well lacks mechanical integrity pursuant to 40 CFR 146.8, written notice of this determination shall be given to the owner or operator. Unless the Director requires immediate cessation, the owner or operator shall cease injection into the well within 48 hours of receipt of the Director's determination. The Director may allow plugging of the well pursuant to the requirements of UAC R317-7 or require Lisbon Valley to perform such additional construction, operation, monitoring, reporting and corrective action as is necessary to prevent the movement of fluid into or between USDWs caused by the lack of mechanical integrity. The owner or operator may resume injection upon written notification from the Director that the owner or operator has demonstrated mechanical integrity pursuant to 40 CFR 146.8.
 - c) The Director may allow the owner/operator of a well which lacks internal mechanical integrity pursuant to Part III (I)(1)(a) of this permit to continue or resume injection, if the owner or operator has made a satisfactory demonstration that there is no movement of fluid into or between USDWs.

PART III. SPECIFIC PERMIT CONDITIONS

A. DURATION OF PERMIT
(R317-7-9.5 and 40 CFR 144.36)

This UIC Class III In-situ copper recovery permit shall be issued for five years unless terminated sooner according to Part II(D)(6)(b) of this permit. The Director shall review permit renewal requests submitted by the Lisbon Valley once every five (5) years to determine whether it should be modified, revoked and re-issued, terminated, or undergo minor modification according to the requirements of Part II (D)(6) of this permit.

B. COMPLIANCE SCHEDULE
(40 CFR 144.53)

Lisbon Valley must address each of the following conditions within the time period indicated for each item. Failure to do so may result in the termination of the permit according to Part II(D)(6)(b) of this permit.

1. Construction Plan

Lisbon Valley shall submit for the Director's approval a Construction Plan, which meets the requirements of Part III (D) of this permit, for all Class III injection wells, any production well that may be used for injection, and any stratigraphic test well. The Plan shall be submitted within 90 days of the effective date of this permit and before construction of any new injection well.

2. Operating Plan

Lisbon Valley shall submit for the Director's approval an Operating Plan which meets the requirements of Part III (F) of this permit, for all injection wells including production wells that may be used for injection. The Plan shall be submitted within 90 days of the effective date of this permit and before the construction of any new injection well.

3. Monitoring, Recording and Reporting Plan

Lisbon Valley shall submit for the Director's approval a Monitoring, Recording and Reporting Plan, which meets the requirements of Part III (G and H) of this permit, for all injection wells including production wells that may be used for injection. The Plan shall be submitted within 90 days of the effective date of this permit and before construction of any new injection well.

Lisbon Valley shall include with the monitoring, recording and reporting plan a piping and instrumentation diagram (P&ID) for all fluid movement into and out of the wells, sampling points, valves, etc.

4. Plugging and Abandonment Plan

Lisbon Valley shall submit for the Director's approval a Plugging and Abandonment Plan, which meets the requirements of Part III (J) of this permit, to include all injection wells, production wells that may be used for injection. The Plan shall be submitted within 90 days of the effective date of this permit but before plugging and abandonment

5. Installation of Continuous Monitoring System

Lisbon Valley shall install a continuous monitoring system to collect injection pressure, injection rate, injection volume, injection temperature, injection conductivity, extraction rate, extraction volume, extraction temperature, and extraction conductivity for all wells.

a) Monitoring Equipment Installation

Lisbon Valley shall have the monitoring equipment of the continuous monitoring system installed no later than 1 year after the effective date of this permit. A report of the achievement of this interim task shall be submitted to the Director no later than 30 days after deadline for completing this task.

b) Continuous Data Logging

Lisbon Valley shall have the database of the continuous monitoring system operational and be collecting continuous data no later than 2 years after the effective date of this permit. A report of the achievement of this interim task shall be submitted to the Director no later than 30 days after deadline for completing this task.

C. CORRECTIVE ACTION

(40 CFR 144.52(2), 40 CFR 144.55, 40 CFR 146.7)

Lisbon Valley shall identify all artificial penetrations into the permitted injection zones for the in-situ copper recovery operation that lie within the 2-mile radius area of review of the project area. For such wells which are improperly sealed, completed, or abandoned, Lisbon Valley shall submit a Corrective Action Plan consisting of such steps or modifications as are necessary to prevent movement of fluid into underground sources of drinking water (USDWs) and/or into the Colorado River. The approved and enforceable Corrective Action Plan, if required, is included as Attachment C of this permit.

D. CONSTRUCTION REQUIREMENTS
(R317-7-10.1(B) and 40 CFR 146.32)

1. Class III Injection Well Construction Standards

Each well shall be constructed according to the requirements for Class III wells set forth in R317-7-10.1(B) and 40 CFR146.32 details of which are included in the following permit conditions.

2. Construction Plan

The approved and enforceable Construction Plan is included as Attachment D of this permit.

3. Changes to the Construction Plan

Changes to the approved Construction Plan must be approved by the Director as a minor modification of the permit according to Part II (D)(6)(c)(6) of this permit. No such changes may be physically incorporated into construction of the wells or wellfield prior to approval of the modification by the Director. All changes must comply with UAC R317-7 and those sections of 40 CFR144 and 40 CFR146 incorporated by reference in the state rule.

4. Casing and Cement

Regulatory Reference: All new Class III wells shall be cased and cemented to prevent the migration of fluids into or between underground sources of drinking water. The Director may waive the cementing requirement for new wells in existing projects or portions of existing projects where there is substantial evidence that no contamination of underground sources of drinking water would result. It is Lisbon Valley's responsibility to provide such evidence to the Director. The casing and cement used in the construction of each newly drilled well shall be designed for the life expectancy of the well. Lisbon Valley shall consider the following factors in designing a casing and cementing program for the well:

- (1) Depth to the injection zone;
- (2) Injection pressure, external pressure, internal pressure, axial loading, etc.;
- (3) Hole size;
- (4) Size and grade of all casing strings (wall thickness, diameter, nominal weight, length, joint specification, and construction material);
- (5) Corrosiveness of injected fluids and formation fluids;
- (6) Lithology of injection and confining zones; and
- (7) Type and grade of cement.

The following requirements pertaining to the cement and casing shall apply:

- a) Only new casing shall be installed.

- b) Surface and intermediate casing strings shall be used to protect USDWs above the uppermost mine.
- c) All casings shall be cemented to protect USDWs and other subsurface resources.
- d) A minimum of one cemented casing shall be set across all formations.
- e) Appropriate cement shall be used for cementing within acidized formations as a result of in-situ copper recovery operations.
- f) Centralizers shall be used on all cemented casing strings and shall be placed to optimize the proper placement of cement in casing-borehole annulus.
- g) Boreholes shall be conditioned prior to running cement.

5. Tubing / Packer

All wells operated in pressurized mode shall be constructed to inject/extract through a screened interval in the casing string or tubing connected to a packer set at the top of the ore zone in the Burro Canyon Aquifer or lower but not lower than the contact with the Morrison Formation.

6. Logging and Testing

Regulatory Reference: Appropriate logs and other tests shall be conducted during the drilling and construction of new Class III wells. A descriptive report interpreting the results of such logs and tests shall be prepared by a knowledgeable log analyst and submitted to the Director. The logs and tests appropriate to each type of Class III well shall be determined based on the intended function, depth, construction and other characteristics of the well, availability of similar data in the area of the drilling site and the need for additional information that may arise from time to time as the construction of the well progresses. Deviation checks shall be conducted on all holes where pilot holes and reaming are used, unless the hole will be cased and cemented by circulating cement to the surface. Where deviation checks are necessary they shall be conducted at sufficiently frequent intervals to assure that vertical avenues for fluid migration in the form of diverging holes are not created during drillings.

All logging and test results must be made available to DWQ upon request.

The following geophysical logs and tests must be performed during construction of each Class III injection well:

- a) Casing Pressure Test according to Part III(I)(9)(a) of this permit.

7. Injection Zone Characterization

- a) Where the injection zone is a formation which is naturally water-bearing the following information concerning the injection zone shall be determined or calculated for new Class III wells or projects:
 - (1) Fluid pressure;
 - (2) Fracture pressure; and
 - (3) Physical and chemical characteristics of the formation fluids.
- b) Where the injection formation is not a water-bearing formation, only the fracture pressure must be submitted.
- c) The approved and enforceable Formation Testing Program is included in the Construction Plan in Attachment D of this permit.

8. Well Stimulation Program

If Lisbon Valley intends to stimulate the well or clean the well bore, enlarge fractures, and increase pore space in the interval to be injected thereby enhancing the injectivity of the well, a Well Stimulation Program must be prepared for the Director's approval and included in the Construction Plan in Attachment D of this permit. Well stimulation commonly refers to hydraulic fracturing, acid fracturing, and matrix acidification. Well stimulation does not include the process of in-situ copper recovery by leaching soluble copper minerals and other incidental reactions of the injectate with the ore and host rock. The expected changes due to injection are described in Attachment K.

9. Monitoring Wells

Attachments B and F provides the locations and design of proposed point of compliance monitoring wells that are required by this permit that must be constructed according to standards set forth in ASTM D5092 / D5092M – 16.

10. Additional Construction Requirements

- a) New Well Construction Plan - No less than 30 days prior to the planned construction of a new well, the Lisbon Valley shall submit individual plans, which meet the requirements of this section, for each new well to be constructed, for review and approval by the Director. Well construction may begin only after receipt of written approval from the Director.
- b) New Mine Workings - No less than 90 days prior to the creation of new conventional mine workings such as shafts etc., Lisbon Valley shall submit for the Director's approval a new hydrogeologic analysis of the mine site in the area of the proposed mine workings and revised construction, operating, monitoring and plugging and abandonment plans to address the potential effect of new mine workings on in situ copper recovery operations.

-
- c) New Stratigraphic Wells (Core Holes) – No less than 30 days prior to the planned construction of a new stratigraphic well, Lisbon Valley shall submit individual plans, which meet the requirements of this section, for each new stratigraphic well to be constructed, for review and approval by the Director. Stratigraphic well construction may begin only after receipt of written approval from the Director.

E. REQUIREMENTS PRIOR TO IN-SITU COPPER RECOVERY
(40 CFR 146.34(b))

In accordance with Part II (D)(13) of this permit, the following requirements must be met prior to the commencement of in-situ copper recovery:

1. Aquifer Exemption for USDWs and Aquifer Restoration Plan

- a) Hydrologic data documenting the presence or absence of a USDW(s);
- b) Aquifer Exemption for the Burro Canyon Aquifer (Attachment M) according to the requirements of 40 CFR 144.7 and 40 CFR 146.4;
- c) Pursuant to 40 CFR Parts 146.10 and 144.12, the Permittee shall comply with the Groundwater Restoration Plan in Attachment H and the Plugging and Abandonment Plans in Attachment I in accordance with the schedule for aquifer restoration, groundwater monitoring, and plugging and abandonment activities to ensure adequate protection of USDWs. The Permittee shall also comply with the conditions at I.1 and I.2 below. Where any conflict or inconsistency exists between the plans in Attachments H and I, the permit conditions shall supersede the language in these Attachments.

2. Well Completion Report

The operator shall submit for the Director's review an injection well completion report consisting of:

- a) All available logging and testing data on the well that is relevant to mechanical integrity of the well (casing pressure test data, casing inspection logs, cement evaluation logs, radioactive tracer test logs, spontaneous potential logs, downhole fluid tester data, etc.);
- b) Results of mechanical integrity testing for each new well;
- c) Actual maximum injection pressure and injection flow rate;
- d) Results of the formation testing program;
- e) Actual in-situ copper recovery procedures;
- f) Status of all wells requiring corrective action within the area of review, if applicable;
- g) Detailed 'As-Built' Well Schematic including:
 - (1) Casing details including size, weight, grade and setting depths,

- (2) Cement details including type, special formulations, calculated volumes, actual pumped volumes, and yield (cubic feet / sack),
- (3) Formation horizons, and
- (4) Groundwater horizons.

h) Explanation and justification for any deviations from approved plan.

3. Director's Approval to Commence In-situ copper recovery

Within 14 days after receipt of the well completion report, the Director shall provide written notice denying or granting approval to commence in-situ copper recovery.

F. OPERATING REQUIREMENTS
(R317-7-10.2(A))

1. Class III Injection Well Operation Standards

Operating requirements for the drilling and in-situ copper recovery of each well are set forth in R317-7-10.2(A) details of which are included in the following permit conditions.

2. Operating Plan

The approved and enforceable Operating Plan that meets all the operating requirements of this section is included as Attachment E of this permit.

3. Maximum Allowable Surface Injection Pressure (MASIP)

The maximum allowable surface injection pressure (MASIP) at the wellhead shall be calculated:

- a) to ensure that pressure in the injection zone does not initiate new fractures or propagate existing fractures in the confining zones; and
- b) to ensure that pressures do not cause migration of injectate or formation fluids into an USDW; and
- c) to ensure that pressure in the Burro Canyon Aquifer does not cause migration of injectate or other fluids to the surface.

4. Borehole – Casing Annulus Injection Prohibited

Injection between the outermost casing protecting USDW's and the well bore is prohibited.

5. Additional Operating Requirements

- a) Injection Formations - Injection shall be limited to well screen intervals allowed from the top of the ore zone within the Burro Canyon Aquifer to the base of the Burro Canyon Aquifer where it contacts the Top of the Morrison Formation.
- b) Injectate Fluid Limitations – Injection fluid is limited to:
 - (1) Raffinate from the Solvent Extraction Electrowinning (SXEW) facility
 - (2) Makeup water or acid solution from other sources after disclosure and Director approval of composition and any new additives or conditioners etc. to enhance the in-situ recovery process
- c) Fluid Levels in Burro Canyon Aquifer – The fluid level in the Burro Canyon Aquifer shall be maintained below the ground surface at all times where the injection zone is unconfined. To this end, the depth of the fluid level in injection, recovery and monitor wells in the operational wellfield as measured from the casing collar shall not be less than 50 feet.
- d) If the ore zone in the Burro Canyon Aquifer is confined by the Mancos Shale Formation the MASIP will not cause the fracture pressure of the Mancos Formation, calculated to be 0.6 pound per square inch per foot of depth, to be exceeded at any depth.
- e) The MASIP will not cause fluid pressures at any depth to exceed the manufacturer-specified maximum operating pressure of the injection piping and fittings. This pressure will not initiate new fractures or propagate existing fractures in the injection or confining zone or cause the migration of lixiviant into any USDW in accordance with 40 CFR § 144.28(f)(6)(i).
- f) Hydraulic isolation from of historical mine workings has been demonstrated by pressure transducer monitoring in the workings (footwall) and in the Project Area (hanging wall). ISR operations target GTO ore will not have any operational relationship with the GTO pit or existing open pit operations. If fluid migrations are detected within existing mine workings, injection activities will be halted until the source and compositions of detected fluids is determined and mitigation of injectate migration to these workings is complete
- g) Injection / Extraction Ratios – To maintain an inward hydraulic gradient, the injection flow will range from 1% to 5% less than the extraction flow depending upon local hydrogeologic conditions and operational variability and the injection and recovery rates will be monitored according to Part III (G) of this permit.

G. MONITORING AND RECORDING REQUIREMENTS
(R317-7-10.3(B), 40 CFR 144.54, and 40 CFR 146.34)

1. Class III Injection Well Monitoring and Recording Standards

Monitoring and recording requirements for the drilling and in-situ copper recovery of each well are set forth in R317-7-10.3(B) and 40 CFR144.54 details of which are included in the following permit conditions.

2. Utah UIC Quality Assurance Project Plan (QAPP)

All monitoring, recording, and reporting of environmental data for the UIC Program shall comply with the most current revision of the Utah UIC QAPP.

3. Monitoring, Recording and Reporting Plan

The approved and enforceable Monitoring, Recording and Reporting Plan that meets all the monitoring and recording requirements of this section is included as Attachment F of this permit.

4. Monitoring Equipment and Methods

Regulatory Reference: All monitoring equipment shall be properly selected, installed, used, and maintained according to the manufacturer's specifications so as to yield data which are representative of the monitored activity. All monitoring methods shall be properly selected and implemented at appropriate intervals and frequency so as to yield data which are representative of the monitored activity. Documentation verifying, if applicable, the proper selection, installation, use, and maintenance of monitoring equipment and the proper implementation of monitoring methods shall be made available to the Director upon request.

5. Injectate Characterization

Regulatory Reference: Lisbon Valley shall monitor the nature of injected fluids with sufficient frequency to yield representative data on its characteristics. Lisbon Valley shall provide qualitative analysis and ranges in concentrations of all monitored constituents, listed below, of injected fluids. Whenever the injection fluid is modified to the extent that this analysis is incorrect or incomplete, a new analysis shall be provided to the Director. Lisbon Valley may request confidentiality in accordance with Part II C of this permit. If the information is proprietary then Lisbon Valley may, in lieu of the ranges in concentrations, choose to submit maximum concentrations which shall not be exceeded. In such a case, Lisbon Valley shall retain records of the undisclosed concentrations and provide them upon request to the Director as part of any enforcement investigation.

Lisbon Valley shall monitor the water quality of the injectate at least quarterly or more frequently if the source of the injectate changes. The water quality of the injectate shall be analyzed for the following constituents:

- a) Inorganics: Sulfate, Acidity
 - b) Acid Soluble Metals (unfiltered sample): Iron, Copper
 - c) Field Measurements: pH, Temperature, Eh, Specific Conductivity
6. Injection Pressure, Injection Rate, and Injection Volume
- Regulatory Reference: The Lisbon Valley shall monitor the injection pressure and either the injection rate or injection volume semi-monthly, or metering and daily recording of injected and produced fluid volumes as appropriate.
- Lisbon Valley shall continuously monitor the injection pressure, injection rate, injection volume, injection temperature, injection conductivity, extraction rate, extraction volume, extraction temperature, and extraction conductivity for all wells and wellfields.
7. Mechanical Integrity Test (MIT)
- Mechanical integrity testing shall be conducted according to Part III (I) of this permit.
8. Injection Zone Fluid Level
- Regulatory Reference: The Lisbon Valley shall monitor the fluid level in the injection zone no less frequently than semi-monthly, where appropriate. Injection zone fluid level monitoring shall be representative of the level during normal operations.
9. Manifold Monitoring
- Regulatory Reference: Lisbon Valley may monitor its Class III injection wells on a field or project basis rather than an individual well basis by manifold monitoring. Manifold monitoring may be used in cases of facilities consisting of more than one injection well, operating with a common manifold. Separate monitoring systems for each well are not required provided the owner/operator demonstrates that manifold monitoring is comparable to individual well monitoring.
10. Additional Monitoring and Recording Requirements
- As of the effective date of this permit or the date the permit was last reviewed, additional permit conditions for monitoring and recording were not required.

H. REPORTING REQUIREMENTS
(R317-7-10.4(B) and 40 CFR 144.54)

1. Quarterly Monitoring Reports
 - a) Schedule for Submitting Quarterly Monitoring Report

<u>Quarter</u>		<u>Report Due On:</u>
1 st Quarter	Jan 1 – Mar 31	Apr 15
2 nd Quarter	Apr 1 – Jun 30	July 15
3 rd Quarter	Jul 1 – Sep 30	Oct 15
4 th Quarter	Oct 1 – Dec 31	Jan 15

b) Content of Quarterly Monitoring Reports

Monitoring data for the following shall be included in the quarterly monitoring reports:

- (1) Injectate Characterization
- (2) Injection Pressure - daily average
- (3) Injection and Extraction Rates, Volumes, Temperature and Conductivity - daily average
- (4) Injection Zone Fluid Level - daily average
- (5) Monitoring Wells according to Attachment F
- (6) Manifold Monitoring, if applicable
- (7) Noncompliance Not Previously Reported – Such reports shall contain a description of the noncompliance and its cause, the period of noncompliance, including exact dates and times, and if the noncompliance has not been corrected, the anticipated time it is expected to continue; and steps taken or planned to reduce, eliminate, and prevent recurrence of the noncompliance.
- (8) Other Required Monitoring

2. Endangering Noncompliance Reporting

Lisbon Valley shall report to the Director any noncompliance that may endanger health or the environment, as follows:

a) Twenty-four Hour Reporting

Endangering noncompliance information shall be provided orally within 24 hours from the time Lisbon Valley becomes aware of the circumstances. Such reports shall include, but not be limited to, the following information:

- (1) Any monitoring or other information that indicates any contaminant may cause an endangerment to a USDW, or
- (2) Any noncompliance with a permit condition, or malfunction of the injection system, which may cause fluid migration into or between USDWs.

b) Five-day Reporting

A written submission shall be provided within five days of the time the Lisbon Valley becomes aware of the circumstances of the endangering noncompliance. The written submission shall contain a description of the noncompliance and its cause, the period of noncompliance, including exact dates and times, and if the noncompliance has not been corrected, the anticipated time it is expected to

continue; and steps taken or planned to reduce, eliminate, and prevent recurrence of the noncompliance.

3. Planned Changes

Lisbon Valley shall give written notice to the Director, as soon as possible, of any planned physical alterations or additions to the UIC-permitted facility. Notification of planned changes on the part of Lisbon Valley, does not stay any permit condition.

4. Anticipated Noncompliance

Lisbon Valley shall give advance notice to the Director of any planned changes in the permitted facility or activity that may result in noncompliance with permit requirements. Notification of anticipated noncompliance on the part of Lisbon Valley, does not stay any permit condition.

5. Permit Transfers

This permit is not transferable to any person except in accordance with Part II (D)(6)(d) of this permit. Lisbon Valley shall notify the Director at least 30 days in advance of the proposed transfer date. Notification shall comply with the requirements in Part II(D)(6)(d) of this permit.

6. Compliance Schedule Reporting

Reports of compliance or noncompliance with, or any progress reports on, interim and final requirements contained in any compliance schedule specified in Part III B of this permit shall be submitted no later than 30 days following each schedule date.

7. Mechanical Integrity Reporting

a) Mechanical Integrity Demonstration - Lisbon Valley shall submit the results of any MI demonstration within 60 days after completion of the test. Lisbon Valley shall include in the report, a detailed description of the tests and the methods used to demonstrate MI. In the case of MI failure, Lisbon Valley shall also describe in detail what and when steps were taken to reestablish MI.

b) Loss of Mechanical Integrity –

(1) In the event of a mechanical integrity failure which may potentially endanger an USDW, report to the Director verbally within 24 hours followed by submission of a written report within 5 days.

(2) Within 15 days after loss of MI, submit to the Director a schedule indicating what will be done to restore MI to the well, or if it will be plugged.

8. Plugging and Abandonment (“As-Plugged”) Report

Within 60 days after permanently or temporarily plugging and abandoning a well, Lisbon Valley shall submit a Plugging and Abandonment Report to the Director.

The report shall be certified as accurate by the person who performed the plugging operation, and shall consist of either:

- a) A statement that the well was plugged in accordance with the P&A Plan(s) previously submitted to, and all conditions of approval provided by, the Director; or
- b) If the actual plugging differed from the approved plan(s), a statement and diagrams defining the actual plugging and why the Director should approve such deviation. Any deviation from the previously approved individual plugging and abandonment plans required by this permit which may endanger waters of the State of Utah, including USDWs, is cause for the Director to require the operator to re-plug the well.

9. Additional Reporting Requirements

a) Permit Review Report

Within 30 days after effective date of this permit, Lisbon Valley shall report to the Director that the person(s) responsible for implementing this permit has read and is personally familiar with all terms and conditions of this permit.

b) Electronic Reporting

In addition to submittal of the hard copy data, Lisbon Valley shall submit the required monitoring data in an Excel spreadsheet.

I. MECHANICAL INTEGRITY

(R317-7-10.3(B) and 40 CFR 146.8)

1. Class III Injection Well Mechanical Integrity Standards

Mechanical integrity testing requirements for each Class III well are set forth in 40 CFR 146.8 details of which are included in the following permit conditions:

An injection well has mechanical integrity (MI) if there is:

- a) No significant leak in casing, tubing, or packer (internal MI), and
- b) No significant fluid movement into an USDW through vertical channels adjacent to the injection well bore (external MI).

2. Mechanical Integrity Testing (MIT) Methods

The following methods are allowed for demonstrating internal and external mechanical integrity of Class III injection wells:

a) Internal MI

- (1) **Standard Annulus Pressure Test (SAPT)** - For Wells Equipped with Tubing and Packer: Following an initial casing pressure test (see Part III(I)(9)(a) – Casing Pressure Tests below), monitoring of the tubing-casing

annulus pressure with sufficient frequency to be representative, as determined by the Director, while maintaining an annulus pressure different from atmospheric pressure measured at the surface;

- (2) **Standard Annulus Monitoring Test (SAMT)** – For Wells Equipped with Tubing and Packer.
 - (3) **Radioactive Tracer Survey (RTS)** – Allowed by Federal Register Notice Volume 52, No. 181; Friday, September 18, 1987; Pages 35324 to 35326 and as revised by Federal Register Notice Volume 52, No. 237; Thursday, December 10, 1987; Pages 35324 to 35326. The timed-run method of running the RTS is the only method approved by EPA to demonstrate MI. The velocity-shot method is not.
 - (4) **“ADA” Pressure Test**
- b) External MI
- (1) **Temperature Survey**
 - (2) **Noise Log**
 - (3) **Oxygen Activation Method (OAL)** – Final approval for use in Federal Register Notice Volume 56, Number 22; Friday, February 1, 1991, Pages 4063 to 4065.
 - (4) **Radioactive Tracer Survey (RTS)** - Allowed by Federal Register Notice Volume 52, No. 181; Friday, September 18, 1987; Pages 35324 to 35326 and as revised by Federal Register Notice Volume 52, No. 237; Thursday, December 10, 1987; Pages 35324 to 35326. The timed-run method of running the RTS is the only method approved by EPA to demonstrate MI. The velocity-shot method is not. The RTS may only be used to demonstrate external MI when the USDW is directly above the injection zone but separated from it by an impermeable confining zone.
 - (5) **Cementing Records and Monitoring Program** – If the nature of the casing precludes the use of the logging methods above, then cementing records may be used to demonstrate external MI provided the monitoring program required by Part III (G) of this permit is designed to verify the absence of significant fluid movement into an underground source of drinking water through vertical channels adjacent to the injection well bore.
- c) The Director may allow the use of a test to demonstrate mechanical integrity other than those listed in a) and b) above with the written approval of the EPA Region 8 Administrator (Administrator). To obtain approval, the Director shall submit a written request to the Administrator, which shall set forth the proposed test and all technical data supporting its use. The Administrator shall approve the request if it will reliably demonstrate the mechanical integrity of wells for which its use is proposed. Any alternate method approved by the Administrator shall be published in the **Federal Register** and may be used in all States unless its use is restricted at the time of approval by the Administrator.

-
- d) In conducting and evaluating the tests enumerated in this section or others to be allowed by the Director, the owner or operator and the Director shall apply methods and standards generally accepted in the industry. When the owner or operator reports the results of mechanical integrity tests to the Director, he shall include a description of the test(s) and the method(s) used. In evaluating the MIT results, the Director shall review monitoring and other test data submitted since the previous evaluation.
- e) The Director may require additional or alternative tests if the results presented by the owner or operator under d) above are not satisfactory to the Director to demonstrate that there is no movement of fluid into or between USDWs resulting from the injection activity.
3. Mechanical Integrity Demonstration Plan
- The Lisbon Valley shall prepare a detailed plan to demonstrate MI to be included in the approved and enforceable Monitoring, Recording and Reporting Plan in Attachment F of the permit. In preparing a plan, which includes MI tests or demonstration methods allowed by the Director, Lisbon Valley shall apply methods and standards generally accepted in the industry for conducting and evaluating the tests (40 CFR 146.8(e)).
4. Mechanical Integrity Demonstration Frequency
- Lisbon Valley shall demonstrate MI for each injection well according to Part III (J)(2) above:
- Before in-situ copper recovery commences;
 - Once every 5 years after the initial demonstration,
 - Following any repair or workover of a well involving the cemented casings, prior to placing it back into operation.
5. Prohibition Without Demonstration
- Lisbon Valley shall not commence injection operation of any new well without:
- Prior demonstration of MI, and
 - Receipt of Director written approval of the MI demonstration.
6. Loss of Mechanical Integrity
- If Lisbon Valley or the Director determines that a well fails to demonstrate MI Lisbon Valley shall:
- Cease operation of the well immediately, and
 - Take steps to prevent losses of solution into USDWs or the surface, and
-

- c) If the mechanical integrity failure may potentially endanger an USDW and/or the surface, report to the Director verbally within 24 hours and submit a written report within 5 days according to Part III (H)(2) of this permit, and
- d) Within 15 days after loss of mechanical integrity, submit to the Director a schedule indicating what will be done to restore mechanical integrity to the well, or if it will be plugged, and
- e) Within 90 days after loss of MI, restore MI or plug and abandon the well in accordance with a plugging and abandonment plan approved by the Director, and
- f) Lisbon Valley may resume operation of the well after demonstration of MI and receiving written approval from the Director.

7. Mechanical Integrity Demonstration Requests

With just cause, the Director may at any time require, by written notice, Lisbon Valley to demonstrate MI of a well.

8. Mechanical Integrity Demonstration Inspections

Lisbon Valley shall allow the Director, or his representative, to observe any or all MI demonstrations. Lisbon Valley shall notify the Director, in writing, of its intent to demonstrate MI, no less than 30 days prior to the intended demonstration.

9. Additional MIT Requirements

a) Casing Pressure Test

To determine the integrity of casing strings set in the well, the operator shall perform a hydrostatic pressure test before drilling out any casing string, before suspending drilling operations, or before completing the well, to the lesser of

- (1) the maximum anticipated pressure to be contained at the surface,
- (2) one psi/ft of the last casing string depth, or
- (3) 70% of the minimum internal yield pressure of any casing subject to the hydrostatic pressure test.

b) Internal Mechanical Integrity Exception

According to 40 CFR 144.51(q)(3), the Director may allow the owner/operator of a well which lacks internal mechanical integrity (Part III (I) (1) (a) of this permit) to continue or resume injection, if the owner or operator has made a satisfactory demonstration of external mechanical integrity (that is, that there is no movement of fluid into or between USDWs.) Such proposals of satisfactory demonstration shall be reviewed and approved or denied on an individual basis.

J. GROUNDWATER RESTORATION REQUIREMENTS

1. Requirement for Groundwater Restoration Plan

Pursuant to 40 CFR Parts 146.10 and 144.12, the Permittee shall comply with the groundwater restoration in Attachment H in accordance with the schedule for aquifer restoration and groundwater monitoring to ensure adequate protection of USDWs. The Permittee shall also comply with the conditions at M below.

K. PLUGGING AND ABANDONMENT REQUIREMENTS

(40 CFR 146.10 and R317-7-10.5)

1. Requirement for Plugging and Abandonment Plan

Lisbon Valley shall develop a plugging and abandonment plan (hereafter, the P&A Plan) for the Class III in-situ copper recovery wells as required by Part II D(15) of this permit. The approved P&A Plan shall become a permit condition of this permit and be incorporated into the permit as Attachment I.

2. Notice of Plugging and Abandonment

Lisbon Valley shall notify the Director in writing no later than 45 days before planned conversion or abandonment of the well(s). This notice shall also include:

a) Well Condition Report

Te Lisbon Valley shall provide a report on the current condition of the well in order to update, supplement or complete any information in the existing P&A Plan. This report shall discuss in detail and evaluate:

- (1) The results of the well's most recent mechanical integrity test,
- (2) The location of any leaks or perforations in the casing,
- (3) The location of any vertical migration of fluids behind the casing, and
- (4) The adequacy of casing cement bonding across the rock formations, as determined from cement bond logs run at the time of well construction or just prior to well abandonment.
- (5) Any supporting data or test results supporting the conclusions of the well condition report shall be attached to the report.

b) Individual Plugging and Abandonment Plan

Lisbon Valley shall also submit an individual P&A Plan for each well to be plugged and abandoned. In coordination with the Well Condition Report, this individual P&A Plan shall modify and supersede previous P&A Plans, as necessary, to ensure adequate plugging and abandonment of the well.

The plugging and abandonment of the well shall be subject to prior Director approval of the individual plugging and abandonment plan. The Director

reserves the right to grant conditional approval of any individual plugging and abandonment plan to ensure adequate plugging of a well.

3. Emergency Well Conversion or Plugging and Abandonment

Emergency conversion or abandonment of wells is allowed by this permit, conditional upon the following requirements:

- a) Lisbon Valley will seek oral approval from the Director for emergency well conversion or abandonment no less than 24 hours prior to the emergency action.
- b) Lisbon Valley will subsequently submit a written request for Director approval of emergency well conversion or abandonment, with appropriate justification, within five (5) working days after receiving oral approval.
- c) The Director reserves the right to modify any oral approval for emergency action, subsequent to review of the written request.
- d) Oral or written approval from the Director for emergency well conversion or abandonment will not waive or absolve Lisbon Valley from its responsibility to comply with the conditions of this permit, including requirements of the P&A Plan.

4. Plugging and Abandonment

Lisbon Valley shall plug and abandon the well(s) consistent with R317-7-10.5, as provided for in the P&A Plan, and any conditions issued by the Director in approval of the individual P&A Plans required by this permit.

5. Inactive or Temporarily Plugged Wells

a) Inactive Wells

After cessation of operation of a well(s) for two years Lisbon Valley shall plug and abandon the well(s), unless Lisbon Valley requests and receives a variance from this requirement from the Director prior to the end of the two year cessation period, based on:

- (1) A demonstration that the well will be used in the future; and
- (2) A satisfactory description of actions or procedures that Lisbon Valley will take to ensure that the well will not endanger an USDW during the period of temporary abandonment. These actions and procedures shall include compliance with technical requirements applicable to active injection wells unless waived by the Director.

b) Temporary Plugging of a Well

Temporary plugging of a well shall consist of:

- (1) Submittal of a notice of well conversion.
- (2) Submittal of a well condition report and an individual plugging plan, for Director approval.

- (3) Submittal of an "As-Plugged" Report as required by this permit.
- c) Temporarily plugged or inactive wells may be reactivated at the discretion of Lisbon Valley after:
 - (1) Submitting a written notification of intent to reactivate to the Director, and
 - (2) Demonstration of mechanical integrity to the Director, as required by this permit, and
 - (3) Receipt of Director written approval of mechanical integrity demonstration and approval to reactivate the well.

L. FINANCIAL RESPONSIBILITY
(R317-7-9.1(24) and 40 CFR 144.52)

1. Demonstration of Financial Responsibility

Lisbon Valley is required to maintain financial responsibility and resources (Attachment J) for groundwater restoration (Attachment H) and to close, plug, and abandon all wells referenced in the approved Plugging and Abandonment Plan (Attachment I), not already plugged and abandoned at the time of issuance of this permit. Satisfaction of this requirement is demonstrated by a Financial Guarantee Bond and Standby Trust Agreement and their associated schedules and exhibits that will included in Attachment J of this permit prior to the Director's authorization to inject.

2. Renewal of Financial Responsibility

Every five (5) years, Lisbon Valley shall demonstrate the adequacy of the financial assurance instrument to close, plug and abandon all wells not permanently plugged and abandoned by Lisbon Valley in compliance with the plugging and abandonment requirements of this permit.

3. Insolvency Financial Responsibility

Lisbon Valley must submit an alternate demonstration of financial responsibility acceptable to the Director within 60 days after any of the following events occurs:

- a) The institution issuing the trust or financial assurance instrument files for bankruptcy; or
- b) The authority of the trustee institution to act as trustee, or the authority of the institution issuing the financial assurance instrument is suspended or revoked.

M. ADDITIONAL CONDITIONS (40 CFR 144.52)

The Director shall impose on a case-by-case basis such additional conditions as are necessary to prevent the migration of fluids into underground sources of drinking water.

As of the effective date of this permit or the date the permit was last reviewed, additional permit conditions were not required.

N. ATTACHMENTS

This page intentionally left blank.

Attachment A

General Location Map of the Lisbon Valley Mine,
San Juan County

This page intentionally left blank.

Attachment B

Map of the UIC Area of Review including the Class III In-Situ
Copper Recovery Injection Wells and the Project Area

This page intentionally left blank.

Attachment C

Corrective Action Plan for Artificial Penetrations into Injection
Zone within Area of Review

This page intentionally left blank.

Attachment D

Injection Well Construction Plan with
Injection Well Construction Details

This page intentionally left blank.

Attachment E

Injection Well Operating Plan and Procedures

This page intentionally left blank.

Attachment F

Monitoring, Recording, and Reporting Plan

This page intentionally left blank.

Attachment G

Contingency Plan for Well Shut-ins or Well Failures

This page intentionally left blank.

Attachment H

Groundwater Restoration Plan

This page intentionally left blank.

Attachment I

Plugging and Abandonment Plan

This page intentionally left blank.

Attachment J

Financial Responsibility

The Standby Trust Agreement along with Schedule A and the Associated Financial Guarantee Bond will be approved and delivered to the DEQ's Office of Support Services prior to Director Authorization to Inject.

These documents shall be updated every five years from the effective date of this permit renewal:

This page intentionally left blank.

Attachment K

Expected Changes Due to Injection

This page intentionally left blank.

Attachment L

Mechanical Integrity Demonstration Protocols

This page intentionally left blank.

Attachment M

Aquifer Exemption Request

This page intentionally left blank.

Attachment A

General Location Map of the Lisbon Valley Mine,
San Juan County

Figure 1.1 Project Location Map

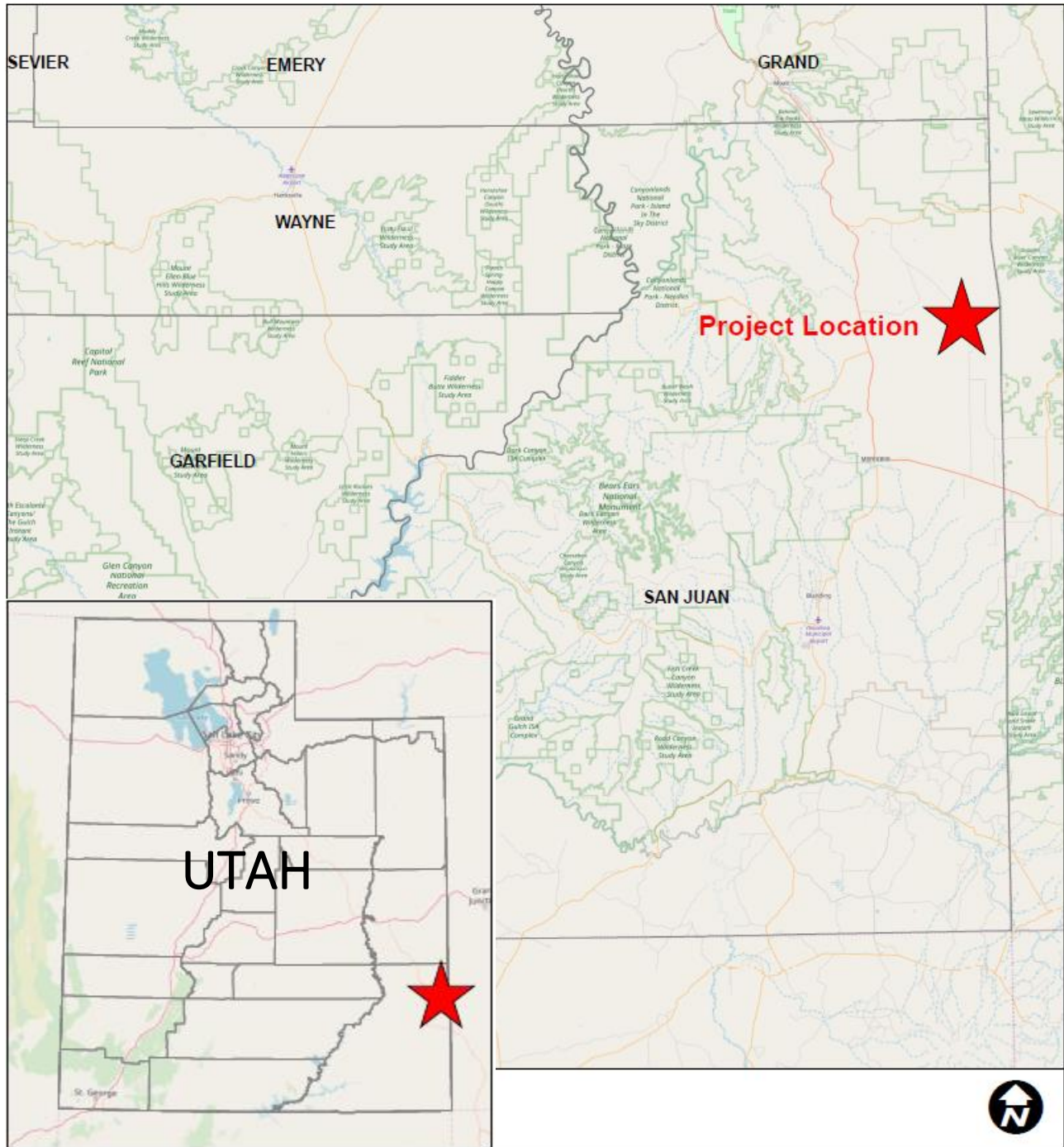

Attachment B

Maps of the UIC Area of Review including Existing and Proposed
Wells and the Project Area

Figure 1.2 LVMC Project Area, Mine Boundary, Aquifer Exemption Boundary and Area of Review

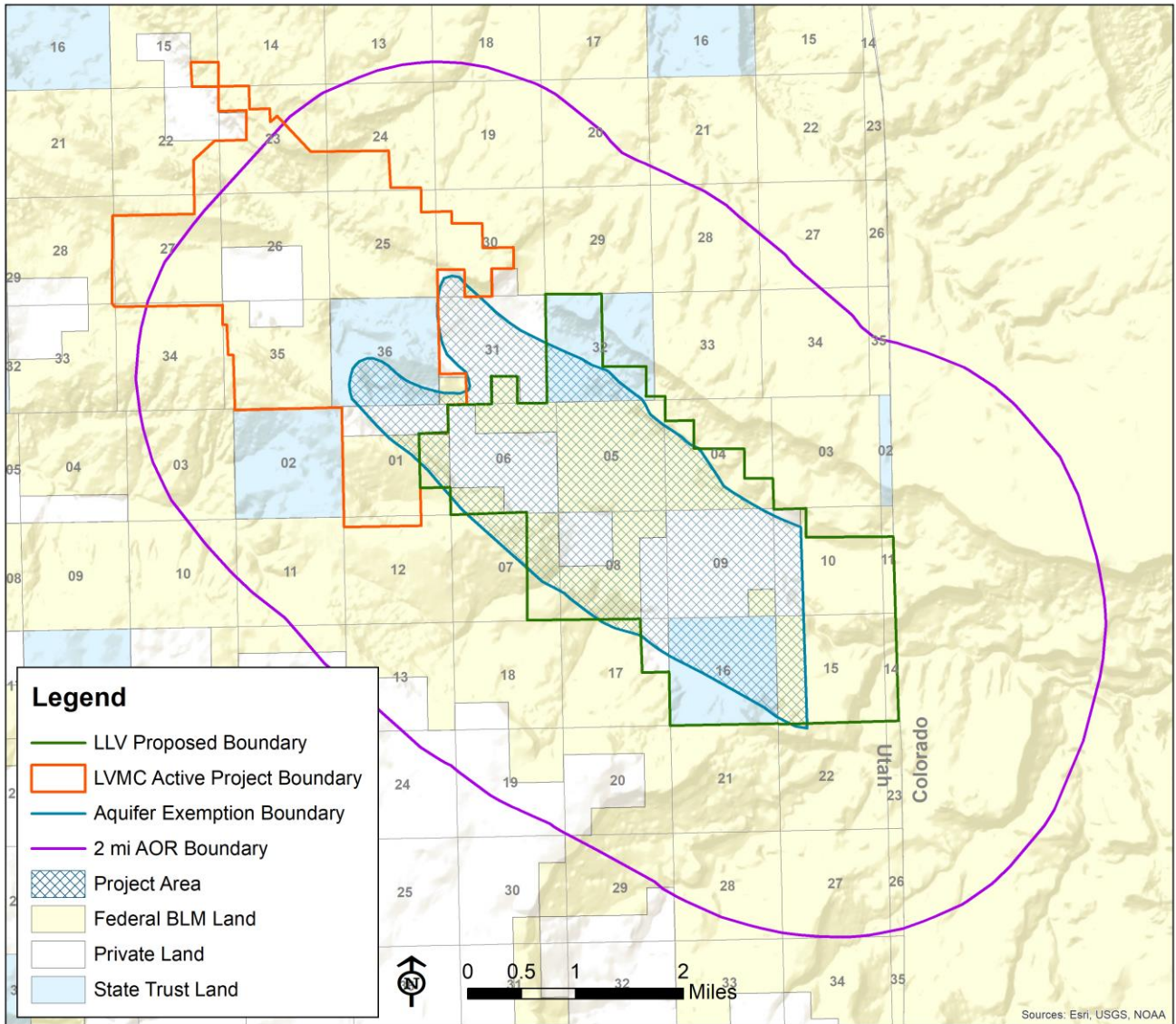

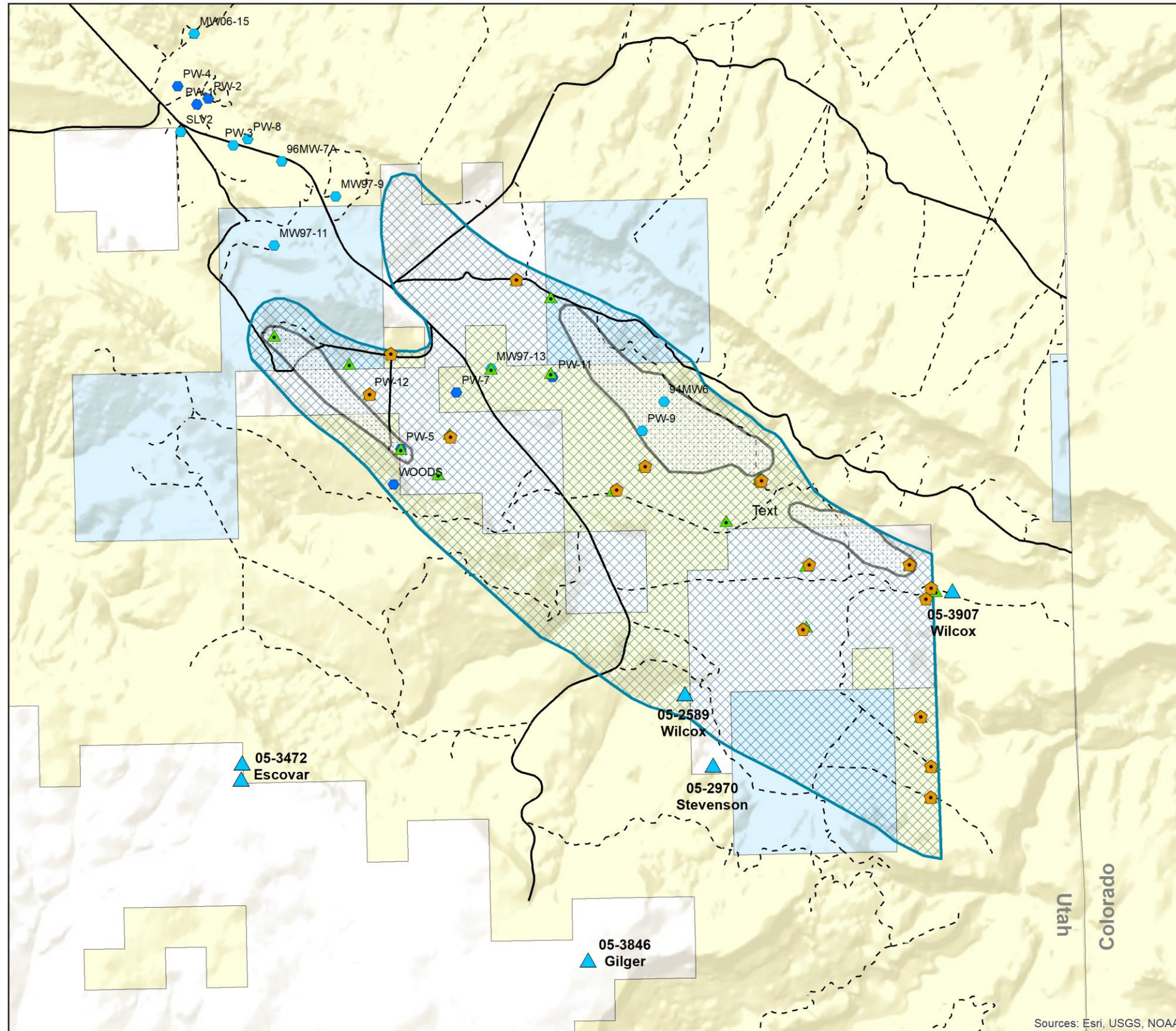

Legend

- Aquifer Exemption Boundary
- Project Area
- Production Wells
- Monitoring Wells
- Proposed BC Aquifer Monitoring Wells
- Proposed Morrison Fm and N Aquifer Monitoring Wells
- Domestic Wells in Use
- Domestic Wells abandoned or not in use
- San Juan Co B Roads
- San Juan Co D Roads
- Federal BLM Land
- Private Land
- State Trust Land



Figure 3.2
Proposed Aquifer Exemption Boundary
 Lower Lisbon Valley Project

Drawn By: Brian Sparks	Date: 24 June 2020
File Name: ISR Figure 3.2 Proposed AEB	

LISBON VALLEY MINING CO

Sources: Esri, USGS, NOAA

Attachment C

Corrective Action Plan for Artificial Penetrations into Injection
Zone within Area of Review

5.0 PART D - Corrective Action Plan

This section describes the necessary steps or modifications to prevent movement of fluid into USDW through any artificial penetrations into the injection zone. There are no USDW above the injection zone. Artificial penetrations into the N Aquifer below the injection is limited to improperly abandoned boreholes and/or wells.

The Company will use the best available information and best professional practices to locate boreholes or wells in the vicinity of potential well field areas. This will include historical records, aerial surveys, pump tests, and field investigations. Consistent with standard industry operating practices and experience, the following describes the procedures the Company will implement to detect and mitigate any unplugged holes or wells that have the potential to impact the control and containment of well field solutions.

The Company has committed to UDWQ to properly plugging and abandoning or mitigating any of the following should they pose the potential to impact the control and containment of well field solutions within the Project Area.

1. Historical wells and exploration holes
2. Holes drilled by the Company for the purposes of delineation and exploration
3. Any well failing mechanical testing integrity including wells drilled by the Company and well drilled by the Company's predecessors

The Company will attempt to locate with best professional practices any presently unknown boreholes or wells in the vicinity of every potential well field. Historical records will be used to determine the presence of previous boreholes and wells.

Should any drill hole or well at or near potential well fields be suspected of being improperly plugged and abandoned, the Company will use best professional practices to precisely locate and re- enter the suspected problem hole with a drill rig or tremie pipe. The Company will evaluate mitigation alternatives including plugging and abandoning the hole or well with grout as described below. The Company may enter the well with logging equipment prior to plugging and abandoning the well to confirm that the well poses a potential problem.

5.1 Plugging and Abandonment Procedures

The Company's standard operating procedures will include plugging and abandoning all boreholes completed during the process of exploration and delineation drilling. Any wells installed by the Company which fail a mechanical integrity test (MIT) and cannot be repaired also will be plugged and abandoned. Plugging and abandonment procedures are discussed in Section 15.

5.2 Mitigation and Avoidance

Boreholes or wells which may potentially impact control of well field operations will be evaluated using pump test data and groundwater modeling. Should it be determined that it is not possible to mitigate potential adverse impacts from any unplugged borehole or well that is discovered, the affected well field will be designed to minimize any potential impacts. The monitoring system will be designed to demonstrate well field control. This may include monitor wells in addition to those provided for normal well field operations.

Attachment D

Injection Well Construction Plan with Injection Well Construction Details

6.0 PART E Injection Zone Formation Testing Plan

This attachment discusses the operating data for the injection wells, including the typical and anticipated maximum injection rate, injection pressure range, and range in concentrations of the injected fluids.

6.1 Injection Flow Rate

The injection flow rates for individual Class III injection wells are anticipated to range from approximately 50 to 100gpm. The project-wide injection flow rate will fluctuate depending on the number of well fields undergoing copper recovery and aquifer restoration. The project-wide injection flow rate is expected to increase from the onset of copper recovery in the first well field through the period of concurrent copper recovery and aquifer restoration. The Company estimates that individual well field copper recovery times will be about 5 years, with multiple well fields typically in copper recovery at any given time. Aquifer restoration will be completed following copper recovery in each well field. Therefore, concurrent copper recovery and aquifer restoration is anticipated to begin approximately five years after initial well field operation.

Figure 10.2 in Section 10 depicts the anticipated project schedule. Table 6.1 summarizes the maximum project-wide flow rates during concurrent copper recovery and aquifer restoration. The maximum gross pumping rate from producing well fields is anticipated to range from 5,000 gallons per minute (gpm) (GTO deposit) to 20,000 gpm (Lone Wolf/Fling Diamond deposit). To maintain an inward hydraulic gradient, the injection flow is estimated to range from 0.5% to 5% less than the extraction flow. This demonstrates that the vast majority of water pumped from the production zone will be reinjected, such that the net withdrawal rate will be only a small fraction of the gross pumping rate. The maximum anticipated gross pumping rate from well fields undergoing aquifer restoration will range from 1,000 gpm (GTO deposit) to 4,000 gpm (Lone Wolf/Flying Diamond deposit). The estimates of production flow rates are used for information purposes only; LVMC is not requesting that the proposed Class III UIC permit include flow limits.

Table 6.1 Operational Flow Rates

Deposit	Operation Phase	Injection Flow Rate	Production Flow Rate
		gpm	gpm
GTO	Copper recovery (5 year)	4,975	5,000
	Aquifer restoration (1 year)	950	1,000
Lone Wolf / FD	Copper recovery (5 year)	19,900	20,000
	Aquifer restoration (1 year)	3,800	4,000

6.2 Injection Pressure

The Company will specify the maximum injection pressure for each well. The designated maximum pressure will be posted near the injection trunk line gauge used to monitor injection pressure. The maximum injection pressure will be calculated as the lowest value of the following:

- The lowest value of maximum allowable wellhead pressure for all injection wells based on fracture pressure calculations presented in Section 8.1.
- The manufacturer-specified maximum operating pressure for the well casing.

- The manufacturer-specified maximum operating pressure of the injection piping and fittings. This pressure will not initiate new fractures or propagate existing fractures in the injection or confining zone or cause the migration of lixiviant into any USDW in accordance with 40 CFR § 144.28(f)(6)(i).

6.3 Injection Fluid Composition

Two different types of fluid will be injected into the well fields. During copper recovery, a lixiviant consisting of production zone groundwater fortified with sulfuric acid and oxygen will be injected into the well fields and recirculated from new and/or existing process collection ponds. Injection solution temperatures are expected to range from 40° F during the winter to 70° F in the summer months. The temperature range results from the temporary residence time in above-grade process ponds. During aquifer restoration, fresh makeup water from the adjacent BC or underlying N Aquifer will be injected into well fields. The BC aquifer may not contain enough water supply to support the ISR project since it does not re-charge or have influent flow. Table 6.2 describes the anticipated range of concentrations for various constituents in the lixiviant injected during copper recovery. The lixiviant formulation illustrated in Table 6.2 is a reflection of metals dissolution in the ore body as a result of the addition of sulfuric acid. This formulation will circulate through the ore body during the mining phase. The formulation will change during restoration when acid is no longer added to the circulation, causing analytes to precipitate.

Table 6.2 Injection Fluid Composition

As ppm	Ba ppm	Cd ppm	Cr ppm	Pb ppm	Hg ppm	Se ppm	Ag ppm	Cu ppm	U ppm	S ppm	Ca ppm	Mg ppm
<1	<1	23	<1	2	<1	<1	<1	637	3		639	2224
<1	<1	24	<1	3	<1	<1	<1	655	3		626	2369

7.0 PART E – Formation Testing Program

This attachment provides a description of the formation testing program for the Project. The formation testing program description includes information about geohydrologic properties of the ore zone and the confining zones from previous tests and information about the pump testing program that will be performed for each well field.

7.1 Fracture Pressure

The Company will not use hydraulic fracturing as part of the ISR process, and no fracture pressure testing is planned. Fracture testing could increase the probability of creating a pathway for loss of fluid control in the immediate vicinity of the tested well. The Company will operate its injection wells below the estimated fracture pressure of the injection zone. Maintaining the native hydraulic properties of the host sand is important to copper recovery and control of well field solutions. Instead of fracture testing the Company will rely on conservative and accepted methods of estimating fracture pressure as described below.

Fracture pressure varies with well depth, strength of formation rock and overburden pressure. Hydraulic pressure is the sum of the overburden pressure and the hydrostatic pressure of fluids within the wellbore. The hydrostatic pressure can be calculated based on the pressure gradient of the fluid multiplied by the fluid depth. The total hydraulic pressure or downhole pressure is calculated as follows:

$$\text{total hydraulic pressure (psi)} = \text{overburden pressure (psi)} + [(\text{fluid pressure gradient (psi/ft)} \times \text{depth (ft)})]$$

To prevent formation fracturing, the total hydraulic pressure or downhole pressure must not exceed the formation fracture pressure. Since the hydrostatic pressure is calculated as the fluid pressure gradient multiplied by the depth, the maximum surface pressure or maximum allowable well head pressure (max WHP) can be calculated as follows:

$$\text{max WHP} = \text{formation fracture pressure (psi)} - \text{hydrostatic pressure (psi)}$$

The formation fracture pressure can be calculated based on the fracture gradient multiplied by the depth.

Fracture gradient is defined by the EPA (2012) as follows:

The fracture gradient is a measure of how the pressure required to fracture rock in the earth changes with depth. It is usually measured in units of "pounds per square inch per foot" (psi/ft) and varies with the type of rock and the stress history of the rock. The default value used by Region 8 in Utah is 0.8 psi/ft. This means, for example, that at a depth of 100 ft, a pressure of 80 psi would be required to fracture the rock, while at a depth of 500 ft, the required pressure would be 400 psi; at 1,000 ft, 800 psi

LVMC will use a fracture gradient value of 0.6 psi/ft as a conservative value for the overlying shale in either the Mancos layer or bed 14. Therefore, the max WHP will be calculated based on the following equation, which uses a fluid pressure gradient of 0.433 psi/ft for the injected fluid:

$$\text{max WHP} = [0.6 \text{ psi/ft} - 0.433 \text{ psi/ft}] \times [\text{depth to top of bed 15 (ft)}]$$

Based on a range of depths to the target mineralization of approximately 125 to 800 feet, the max WHP will range from approximately 20 to 133 psi. The maximum allowable WHP will be calculated on a well-by-well basis, and operational controls will be put in place to prevent exceeding designated pressures. The maximum injection pressure will be designated for each header house as described in Section 6.2. The designated maximum injection pressure will be posted near the injection trunk line gauge used to monitor injection pressure. This practice will ensure the formation fracture pressure is not exceeded according to 40 CFR § 144.28(f)(6)(i).

7.2 Project Area Pumping Tests

7.2.1 Pump Test Summary

Comprehensive aquifer tests have been conducted on seven groundwater production wells in the Project Area. This includes five BC aquifer tests and two N aquifer tests. The Company uses pump tests to determine well yields and aquifer hydraulic conductivities. Step-drawdown tests were conducted to determine well hydraulics. Constant discharge tests were conducted to determine aquifer properties. The pump tests support good permeability of the BC aquifer which supports flow criteria required for successful ISR operations. Additionally, one of the pump tests illustrates geologic confinement of the BC aquifer. Appendix I provides reports documenting pumping tests that have been conducted in the Project Area. A summary of the reports in these appendices is provided below.

7.2.1.1 BC Aquifer

PW-5. Two pumping tests were conducted at well PW-5 shortly after well completion and development in 2004: a step-drawdown test and a constant discharge test. The 4-hour step-drawdown test was conducted at rates of 194, 259, and 307 gpm for 45-60 minutes per step. Water levels did not stabilize at each step, but were continuing to drop at rates of 0.13 ft/min, 0.20 ft/m, and 0.26 ft/min for the three steps, respectively. The non-linear well loss constant (C) was calculated from Jacob (1950) to be 1.8×10^{-4} ft/gpm² and the linear well loss coefficient was calculated at 0.15 ft/gpm.

A 24-hour constant-discharge pumping test was conducted in PW-5 starting on June 7, 2004 using a 60 hp Grundfos 230S submersible pump (rated for 160 to 320 gpm) which was set at 512 ft bgs on 4-inch drop pipe in PW-5. The test was initially conducted at 315 gpm, but the insulation burned through on one lead wire and the pump kicked off after 1 hour and 10 minutes. The test was re-started after 2.5 hours, and the well was pumped for 24 hours at an average rate of 220 gpm.

Maximum drawdown at the end of 24 hours was 84 feet, which equated to a specific capacity of 2.6 gpm/ft. The 84-ft drawdown was small, relative to the available drawdown of approximately 240 ft. The constant discharge test results were analyzed using the Theis, Theis recovery, Cooper-Jacob, Cooper-Papadapalous, Jacob recovery, and Moench methods. The analysis of drawdown at the pumping well produced higher hydraulic conductivity results during pumping (2.56×10^{-4} to 3.98×10^{-4} cm/sec) than during recovery (1.72×10^{-4} to 1.74×10^{-4} cm/sec). Given an aquifer saturated thickness of 333 ft, the

hydraulic conductivity is 1.69×10^{-4} cm/sec. In conclusion, the hydraulic conductivity of the Burro Canyon aquifer at PW-5 ranges from a low of 1.73×10^{-4} cm/sec (the geometric mean of two recovery test analyses) to a high of 3.98×10^{-4} cm/sec (the Theis analysis) with a best estimate of 3.48×10^{-4} cm/sec.

PW-6. Two pumping tests were conducted at well PW-6 shortly after well completion and development: a 2-hour step-drawdown test on June 5 and a 24-hour constant discharge test on June 6 - 7, 2005. The step-drawdown test in PW-6 was conducted on May 19, 2005 using a 50 hp Grundfos 230S submersible pump was set at 435 ft bgs on 3-inch drop pipe. Step tests were conducted at 245, 260, 272, and 282 gpm. Each step was run for approximately 30 minutes, and water levels stabilized quickly at each flow rate. The maximum drawdown was 59.5 ft at a flow rate of 282 gpm.

The non-linear well loss constant (C) was calculated from Jacob (1950) to be 1.86×10^{-4} ft/gpm² and the linear well loss coefficient was calculated at 0.16 ft/gpm, as summarized in 7.1. These constants can be used to calculate the expected drawdown for any pumping rate. For example, the expected drawdown resulting from aquifer loss and well loss at a pumping rate of 400 gpm is 92.4 ft

PW-9. An 18.25-hour pumping test was conducted in well PW-9, from September 13 - 14, 2007 using a 15 HP Grundfos 150S submersible pump to accommodate the low flow rates. The pump intake was set at 298 ft below ground surface, and the water level was drawn down to the pump intake with an average pumping rate of 33.9 gpm. Water levels were measured throughout the 18.25-hour pumping test and for 28 hours after the pump was shut off, at which time the water level had recovered to within 2.7 feet of the static, pre-test water level. The pumping and water level recovery data from the 18.25-hour pumping test was analyzed using unconfined and leaky solutions. Analysis of the drawdown data yielded higher hydraulic conductivities (geometric mean = 4.06×10^{-5} cm/sec) than recovery data (geometric mean = 1.57×10^{-5} cm/sec). The best estimate of aquifer hydraulic conductivity at PW-9 is 2.52×10^{-5} cm/sec.

PW-12. An aquifer pumping test was conducted at well PW-12 shortly after well development in October, 2012. The well was pumped at three different flow rates (steps) leading into a constant discharge test and a recovery test. The stepped flow rates of 46 gpm, 62.2 gpm, and 99.5 gpm were selected based on the characteristics of the aquifer and the limitations of the test pump. For the constant discharge test, PW-12 was pumped at an average flow rate of 96 gpm for 24 hours, resulting in 155.7 ft of drawdown. Water levels recovered to within 4 feet of static in less than two hours.

The hydraulic conductivity analysis was conducted using a Theis solution for the step test in a confined aquifer, and was solved as both fully penetrating (where thickness $b = 200$ ft) and partially penetrating (where $b = 400$ ft and screen length $L = 200$ ft). The fully penetrating solution provided more realistic results, as the well efficiency was more reasonable (63% FP vs. 111.3% PP). The fully penetrating solution is plausible since the well is completed with filter pack sand to the top of the aquifer. Storage was fixed at 0.00005 in the analysis, however the solutions are insensitive to this parameter. The best estimate of Burro Canyon aquifer properties at PW-12, based on the fully penetrating analysis, is transmissivity (T) = 235 ft²/day, $b = 200$ ft, and hydraulic conductivity $K = 1.2$ ft/d (4.2×10^{-4} cm/sec). Note, however, that aquifer boundary conditions have a more significant effect on actual drawdowns observed during longer-term pumping in Lisbon Valley.

PW-12 is equipped with a permanent submersible pump, and is plumbed into the raw water system. Static water level prior to pumping was 5,830.8 ft amsl (500.6 ft btoc). Well PW-12 currently yields

approximately 150 gpm with drawdown of 700 ft. Specific capacity ranges from 0.63 to 0.84 gpm/ft with an average of 0.70 gpm/ft.

17RC-243. An aquifer pumping test was performed in open borehole 17RC-243 on March 13, 2018. The bore hole was pumped for 175 minutes at an average rate of 6.64 gpm (ranging from 0.8 to 25 gpm). Flow rate during the test was highly variable, as valve adjustments were made to achieve a relatively constant discharge rate under changing head conditions. A total of 1,162 gallons were pumped, resulting in a drawdown of 28.55 ft. Plots of residual drawdown showed a change in slope at about $t/t' = 2.6$ to 2.7, indicating that recovery data were affected by a boundary condition at about 103 to 110 minutes after the pump was shut off, with the water level recovery prior to 103 minutes being affected by higher hydraulic conductivity of the formation closer to the well and recovery after 110 minutes being affected by lower hydraulic conductivity of the formation farther away from the well. The Theis analyses for confined and unconfined conditions considered the entire recovery dataset and provided identical estimates of transmissivity and hydraulic conductivity of 68 ft²/day and 2.3×10^{-4} cm/sec, respectively. The results of the Theis analyses fell between the high and low estimates from the residual drawdown analyses.

7.2.1.2 N Aquifer

PW-7. Two pumping tests were conducted in well PW7 shortly after the well was deepened and cased in June 2006: a 2.5-hour step-drawdown test and a 24-hour constant discharge test. Four steps were conducted for approximately 30 minutes each, at pumping rates of 160, 145, 132, and 130.4 gpm. Drawdown stabilized at 39.2, 37.8, 34.4, and 33.9 for each step, respectively, resulting in a non-linear well loss constant (C) of 5.3×10^{-4} ft/gpm² and a linear well loss coefficient of 0.18 ft/gpm.

The 24-hour constant-discharge pumping test in PW-7 was conducted at an average flow rate of 147.2 gpm, and a total of 206,700 gallons were pumped. Maximum drawdown at the end of 24 hours was 51 feet, equating to a specific capacity of 2.9 gpm/ft. The results were analyzed using the Theis, Theis recovery, Cooper-Jacob, Cooper-Papadapalous, and Jacob recovery methods, and indicated higher hydraulic conductivity results during pumping (2.56×10^{-4} to 3.98×10^{-4} cm/sec) than during recovery (1.72×10^{-4} to 1.74×10^{-4} cm/sec). The analysis concluded that the hydraulic conductivity of the N-aquifer at PW-7 ranges from a low of 1.19×10^{-4} cm/sec (the Jacob early-time recovery test analyses) to a high of 6.43×10^{-4} cm/sec (the Theis analysis) with a best estimate of 2.89×10^{-4} cm/sec

Water levels were measured in monitoring well MW97-13, which is completed in the N-aquifer 1,358 feet from well PW-7. The monitoring well showed no response to pumping at PW-7.

PW-11. An aquifer pumping test was conducted on well PW-11 in July 2013. The well was pumped at an average rate of approximately 30 gpm for 8.5 hours, for a total of 16,260 gallons discharged. The pump was shut off when the water level drawdown approached the pump intake.

PW-11 was equipped with a permanent submersible pump, and is plumbed into the raw water system. Static water level prior to pumping was 5,183.4 ft amsl (1,148 ft btoc). The well yields approximately 50 gpm with drawdown of 500 – 550 ft. Specific capacity ranges from 0.06 to 0.12 gpm/ft with an average of 0.09 gpm/ft.

7.3 LVMC Pump Test Conclusions

LVMC pump testing supports anticipated hydraulic conductivity in the BC aquifer from 10^{-4} to 10^{-3} cm/sec range. This range is suitable for ISR at the head pressures that will be induced from gravity flow from surface ponds.

Table 7.1 Summary of Hydraulic Conductivity Results

Well	Pump Intake Depth (ft)	Aquifer	Final Drawdown (ft)	Hydraulic Conductivity Low Range (cm/sec)	Hydraulic Conductivity High Range (cm/sec)	Hydraulic Conductivity Best Estimate (cm/sec)	Hydraulic Conductivity Best Estimate (ft/day)
PW-5	512	Burro Canyon	61.54	---	---	---	---
PW-5	512	Burro Canyon	83.57	1.71E-04	3.98E-04	3.48E-04	0.99
PW-6	435	Burro Canyon	59.47	---	---	---	---
PW-6	435	Burro Canyon	65.96	2.23E-03	6.21E-03	2.66E-03	7.53
PW-12	794.6	Burro Canyon	155.71	4.20E-04	4.20E-04	4.20E-04	1.19
LS-243	295.3	Burro Canyon	28.55	1.10E-04	4.50E-04	2.30E-04	0.65
PW-7	1,000	N-aquifer	39.18	---	---	---	---
PW-7	1,000	N-aquifer	51.49	1.19E-04	6.43E-04	2.89E-04	0.82
PW-11	---	N-aquifer	---	---	---	---	---
PW-12		Burro Canyon		---	---	---	---
PW-12		Burro Canyon	155.71	4.20E-04	4.20E-04	4.20E-04	1.19

7.3.1 LVMC Pump Testing 1995-2013







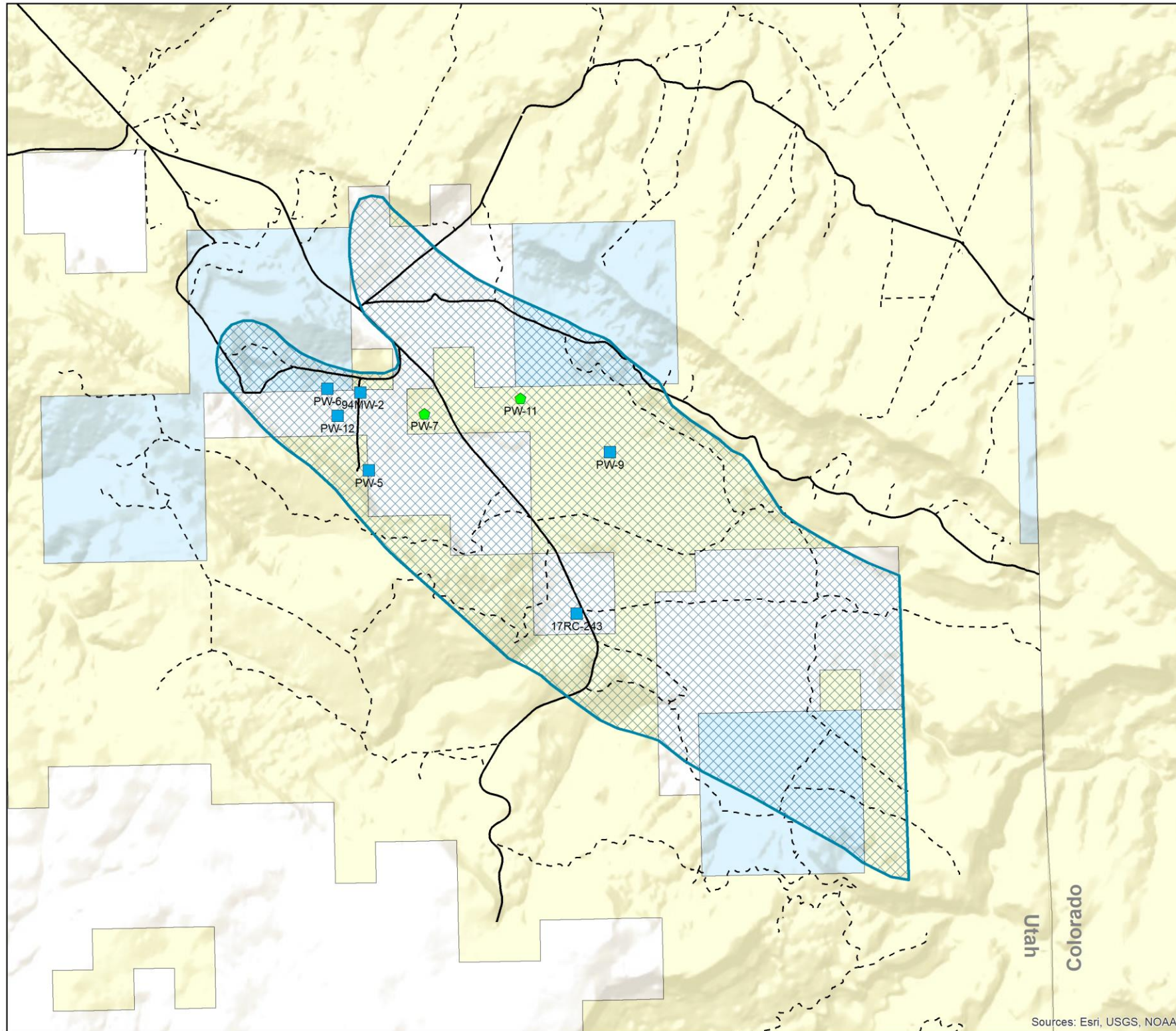

In addition to the tests described above, Adrian Brown Consultants and Whetstone Associates conducted numerous aquifer tests in wells and boreholes, with and without observations wells, from 1995 to the present at the Lisbon Valley site. These tests included constant discharge pumping tests, variable-discharge pumping tests, step-drawdown tests, and slug tests in wells SLV3, PW-1, PW-2, PW-3, PW-4, 95R1, and MW96-7B, and in piezometers 98R3, 98R4, 98R7, 98R8, and PW97-1A.

Based on review of the testing results by LVMC, significant conclusions from the testing indicate:

- Transmissivity of the BC aquifer based on the analysis of late time data averaged about 122 ft²/day, with a geomean hydraulic conductivity of 0.61 ft/day (2.1×10^{-4} cm/sec). The specific storage of the BC aquifer is estimated at 3×10^{-5} (dimensionless).
- The best estimate of transmissivity for the N aquifer is about 400 ft²/day, with a hydraulic conductivity of 2.9×10^{-4} cm/sec. The specific storage of the N aquifer is estimated at 1×10^{-5} (dimensionless).
- The vertical hydraulic conductivity of the Morrison aquitard calculated using the Field Determination of the Hydraulic Properties of Leaky Multiple Aquifer Systems method (Neuman and Witherspoon, 1972). Vertical conductivities ranged from 5.0×10^{-8} to 5.25×10^{-7} cm/sec.



Legend

-  Aquifer Exemption Boundary
-  Project
-  BC Aquifer Test
-  N Aquifer Test
-  San Juan Co B Roads
-  San Juan Co D Roads
-  Federal BLM Land
-  Private Land
-  State Trust Land

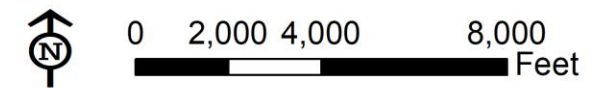



Figure 7.1
Aquifer Test Locations

Lower Lisbon Valley Project

Drawn By: Brian Sparks	Date: 22 June 2020
File Name: ISR Figure 7.1 Aquifer Test Locations	



LISBON VALLEY MINING CO

7.4 PW-5 Transducer Test & Study

LVMC conducted a groundwater elevation study in the summer of 2019 as part of well rehabilitation work on BC aquifer production well PW-12. The study involved intermittent groundwater pumpage from on both sides of the GTO fault. This fault isolates the BC and N aquifers along the 3 Step footwall. The study focused on groundwater monitoring at the fault (PW-5) during intermittent pumpage from the hanging wall (PW-12) and footwall (Woods well). Groundwater elevation monitoring at the GTO fault was accomplished using a pressure transducer in PW-5.

7.4.1 Background

PW-12 is an important supply well located in LLV near the GTO deposit in the BC aquifer. Since installation in 2012, pumpage from PW-12 has locally dewatered the BC aquifer including water levels in former BC production well PW-5. This well is currently used as a piezometer with insufficient water for pumping. The Woods well is located on the 3 Step footwall and pumps groundwater from the N aquifer. The N aquifer head at the Woods wells is >200 feet higher than the BC aquifer head at PW-5. Therefore an influent head gradient occurs across the GTO fault. Both PW-12 and Woods well are aggressively pumped in the summer due to high process water demands at the Lisbon Valley Mine. Well locations and GTO fault are shown on Figure 7.6.

PW-5 terminates in the GTO fault separating the BC aquifer from N aquifer along the 3 Step footwall. It's location and design are ideally located for groundwater elevation changes from PW-12 pumping. It is equally well suited for monitoring potential groundwater elevation changes from water leakage across the GTO fault from the 3 Step footwall.

The summer of 2019 was highly problematic with well pump failures at PW-12 and pump cavitation issues at the Woods well. This resulted in both wells being pumped intermittently and at separate times. The aggressive, yet intermittent pumpage from both aquifers located on separate sides of the GTO fault provided an ideal opportunity to implement transducer monitoring in PW-5.

Figure 7.7 shows the PW-5 pressure hydrograph and 5-week time period extending from July 8 to August 13. Woods well began its seasonal pumpage on July 8 at a rate of 150 gpm. At this time, PW-12 was pumping at a rate of 120 gpm. On July 14, the column pipe failed on PW-12 damaging the pump and taking the well out of service. This resulted in an immediate head inflection at PW-5 (Inflection #1). The pump was reinstalled in in PW-12 on July 17 without knowledge that the pump was damaged. This resulted in a second inflection as PW-12 pumpage decreased PW-5 groundwater elevation (transducer pressure). Near the end of July the flow rate from the damaged pump in PW-12 began to decline. This resulted in 3rd inflection as the pressure head at PW-5 increased. PW-12 was taken out of service at 3rd time on July 31 and the pump replaced on August 11. This resulted in a 4th inflection as pumpage reduced pressure at PW-5.

The Company is continuing PW 5 study and analysis.

Figure 7.2 PW-5 Transducer Study Location Map

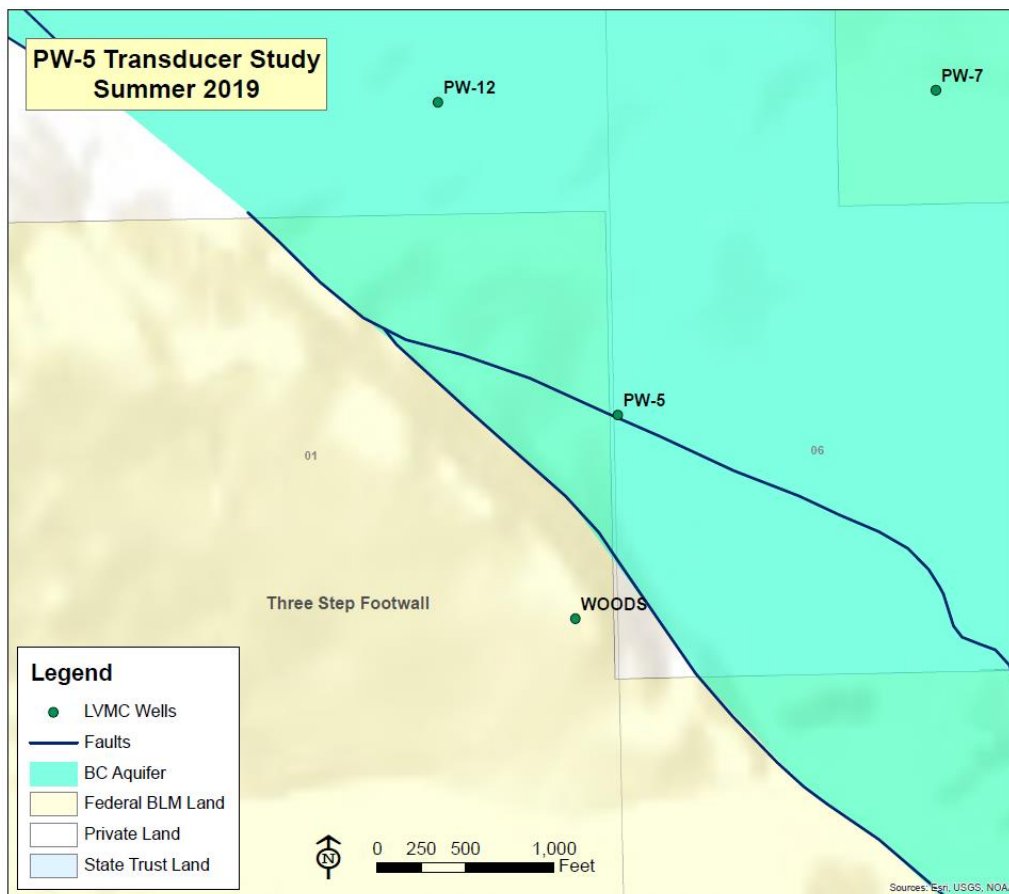
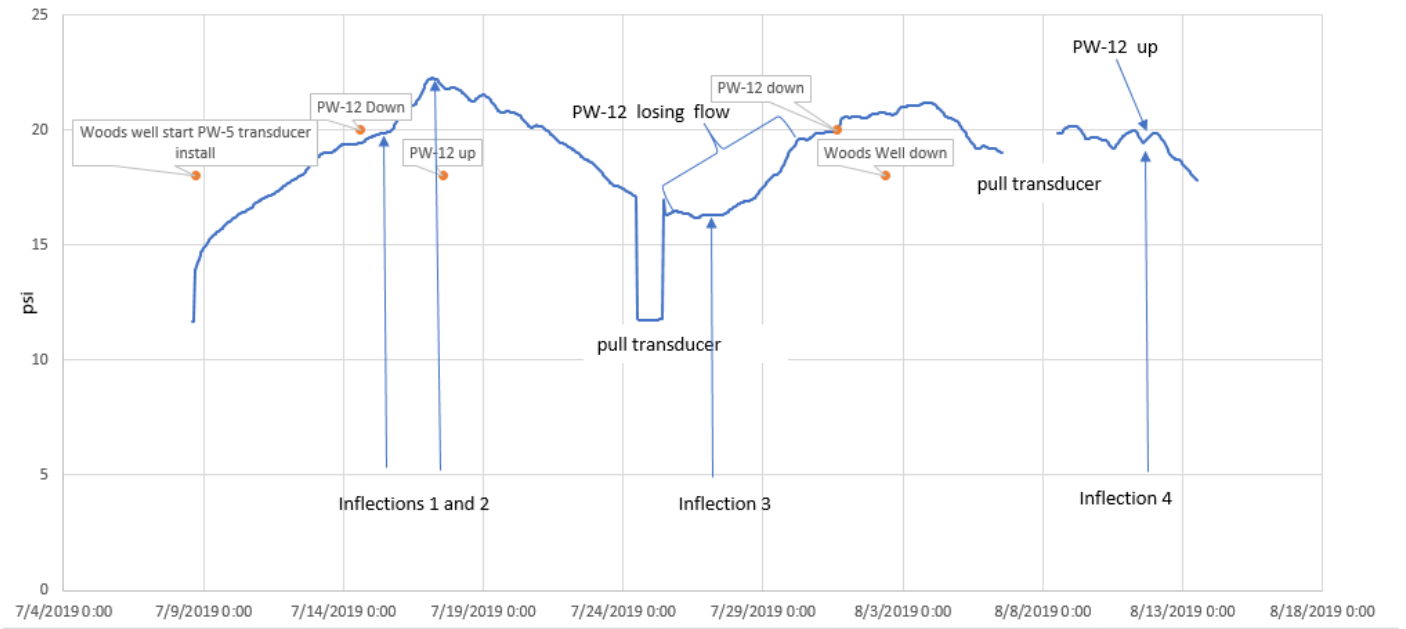

Figure 7.3 PW-5 Transducer Pressure



7.4.2 Summary and Conclusions

The BC and N aquifers occur juxtaposed along the GTO fault near PW-5. The aquifers were both pumped intermittently over a 5-week period at flow rates greater than 100 gpm. Pumpage from the BC aquifer at PW-12 influences the BC aquifer head at PW-5. The pressure influence is almost immediate reflecting hydraulic connection and confined groundwater conditions. Pumpage from the Woods well does not appear to influence the pressure head at PW-5. The GTO fault appears to behave as a hydraulic seal reflecting the occurrence of high SGR material.

7.5 Pre-Operational Pump Testing for Each Well Field

The following pump testing procedures will be used to establish that the production and injection wells are hydraulically connected to the perimeter production zone monitor wells, that the production and injection wells are hydraulically isolated from non-production zone vertical monitor wells, and to detect potentially improperly plugged wells or exploration holes. Pump testing results will be included in the well field hydrogeologic data packages.

7.6 Pump Testing Design

An extensive pump test program will be designed and implemented prior to operation of each well field to evaluate the hydrogeology and assess the ability to operate the well field. Prior to pump testing several important well field development steps will be completed:

- 1) Delineation drilling at spacing sufficient to finalize well field design. As standard procedure, all delineation holes will be plugged and abandoned after drilling.

- 2) Detailed mapping of the ore bodies targeted for ISR operations and the lithology of overlying and underlying confining units.
- 3) Revision of the conceptual geology and hydrogeology including definition of aquitards and ore zone units to be produced or monitored.
- 4) Design of the production and injection wells including well locations and screened intervals.
- 5) Design of the monitor well system based on production and injection well locations and refined conceptual geology and hydrogeology.
- 6) Specification of all monitor well locations and screened intervals.
- 7) Installation of all monitor wells and production wells to be used during pump testing.

7.7 Pump Test Procedures

Appropriate wells as needed for characterization and regulatory purposes will be monitored during the pumping test, including but not necessarily limited to the following wells:

- 1) Pumping wells,
- 2) Monitor wells within the production zone,
- 3) Perimeter production zone monitor wells,
- 4) Monitor wells in the immediately overlying non-production zone sand unit,
- 5) Monitor wells in each subsequently overlying non-production zone sand unit,
- 6) Monitor wells in the alluvium, if present,
- 7) Monitor wells in the immediately underlying non-production zone sand unit, if the production zone does not occur immediately above the Morrison,
- 8) Any additional wells installed for investigating other hydrogeologic features, and
- 9) Any other wells within proximity to the well field that have been identified as having the potential to impact or be impacted by ISR operations

In general, the monitoring system wells will be monitored using downhole data logging pressure transducers, which will be corrected for variations in barometric pressure. Some manual measurements with electronic meters also may be made.

Prior to testing, static potentiometric water levels will be measured in every well in the monitoring system. Where a sufficient number of data points exist, these data will be used to map the pre-operational potentiometric surface for each unit including alluvium, where present. Because of the high density of wells and, any leakage across aquitards due to improperly plugged boreholes or wells typically will become apparent while preparing potentiometric surface maps. Water samples will be collected from selected N aquifer monitor wells and analyzed for baseline parameters. The N aquifer water quality will be evaluated to identify any potential areas of leakage across aquitards due to improperly plugged boreholes or wells.

Pump testing will involve inducing stress on the production zone ore zone by operating pumping wells. The goal of the test will be to demonstrate suitable conditions for ISR operations. This will be done by causing drawdown in the production zone extending to all perimeter monitor wells, creating a cone of depression across the well field area to test the confinement between the ore zone and the overlying and underlying confining units, if present, and addressing potential leakage through confining units via improperly sealed or unplugged exploration boreholes, or associated with naturally occurring geologic features. The presence or lack of response in vertical monitor wells will be used for evaluation of confinement between these units and for identification of leakage due to anomalies such as improperly plugged boreholes. If leakage is present, the relative responses in the overlying, underlying, and/or alluvial monitor wells will indicate the proximity and direction toward the source of leakage.

The pumping test duration will be sufficient to create a suitable response in the perimeter monitor wells, typically a minimum drawdown of 1 foot. If hydrogeologic conditions dictate, less response may be adequate to show a direct cause and effect from pumping.

The flow rate of the pumping test will be based on well capacity and design requirements. More than one pumping well may be required to create drawdown in all perimeter wells.

Measurements during pump testing will include instantaneous and totalized flow, periodic pressure transducer measurements, barometric pressure, and time. A step rate test will be performed initially. There will be an initial stabilization phase with no flow, a stress period of constant flow, and a recovery period with no flow

7.8 Pump Test Evaluation

Evaluation of pump test data will address the following:

- 1) Demonstration of hydraulic connection between the production and injection wells and all perimeter monitor wells and across the ore zone.
- 2) Verification of the geologic and hydrologic conceptual model for the well field.
- 3) Evaluation of the vertical confinement and hydraulic isolation between the production zone and overlying and underlying units.
- 4) Calculation of the hydraulic conductivity, storativity, and transmissivity of the ore zone.
- 5) Evaluation of anisotropy within the ore zone.

7.9 Well Field Hydrologic Data Packages

Pump testing data and results will be included in the well field hydrogeologic data packages, which will be prepared in accordance with UDWQ permit requirements. This section describes the contents and evaluation of the well field hydrogeologic data packages. These will be reviewed by the UDWQ.

Upon completion of field data collection and laboratory analysis, the well field hydrogeologic data packages will be assembled and submitted for review by the UDWQ UIC Program for evaluation. The UDWQ UIC Program evaluation will determine whether the results of the hydrologic testing and the planned ISR operations are consistent with standard operating procedures and technical requirements

stated in the UDWQ permit. The evaluation will include review of the potential impacts to human health and environment. Relevant portions also will be included in the injection authorization data packages. If anomalous conditions are present or the evaluation indicates potential to impact human health or the environment, the well field hydrogeologic data package will be submitted to UDWQ for review and approval. The well field hydrogeologic data package and written evaluation will be maintained at the site and available for regulatory agency review.

Each well field hydrogeologic data package will contain the following:

- 1) A description of the proposed well field (location, extent, etc.).
- 2) Map(s) showing the proposed production and injection well patterns and locations of all monitor wells.
- 3) Geologic cross sections and cross section location maps.
- 4) Isopach maps of the production ore zone and overlying and underlying confining units.
- 5) Discussion of how pump testing was performed, including well completion reports.
- 6) Discussion of the results and conclusions of the pump testing, including pump testing raw data, drawdown match curves, potentiometric surface maps, water level graphs, drawdown maps and, when appropriate, directional transmissivity data and graphs.
- 7) Baseline water quality information including proposed upper control limits (UCLs) for monitor wells and target restoration goals (TRGs).
- 8) Any other information pertinent to the proposed well field area tested will be included and discussed.

7.10 Injection Authorization Data Packages

Injection authorization data packages will be prepared and presented to UDWQ for each well field. Each injection authorization data package will contain the following: A description of the proposed well field (location, extent, etc.).

- 1) Map(s) showing the proposed production and injection well patterns and locations of all monitor wells.
- 2) Geologic cross sections and cross section location maps.
- 3) Discussion of how pump testing was performed, including well completion reports and MIT results.
- 4) Discussion of the results and conclusions of the pump testing, including pump testing raw data, drawdown match curves, potentiometric surface maps, water level graphs, drawdown maps and, when appropriate, directional transmissivity data and graphs.
- 5) The calculated formation fracture pressure for each well and the designated maximum injection pressure for each well.
- 6) Commitment to completing MIT and preparing well completion reports for all injection wells prior to initiating injection into the well field.
- 7) Schedule for proceeding with operation of the well field.

8.0 PART F - Well Stimulation Plan

A stimulation program is not proposed for the Project injection wells.

Well development (described in Section 11.4), which will include swabbing, will be used to improve well yield by enhancing hydraulic communication between the aquifer and the well.

9.0 PART G - Injection Well Construction Plan

The Company will install all wells using a downhole hammer and compressed air or reverse circulation. Hole sizes will range from 6 ½ to 9 7/8". Limited additives will be used to form a wall cake in the Mancos Fm.

10.0 PART H - Injection Construction Details

This attachment details the construction procedures that will be utilized for injection, production and monitor wells at the Project. All injection and production wells will be completed in accordance with Utah well construction standards and EPA standards for Class III UIC wells.

10.1 Well Construction Materials

Well casing material will be polyvinyl chloride (PVC) and High Density Polyethylene (HDPE) with minimum SDR 17 wall thickness. Use of this casing material has been approved at other ISR sites, such as the Cameco Resources Smith Ranch Project in Wyoming, also known as the Crow Butte Site (Cameco, 2012; NRC, 2016). The construction of the wells within the AOR will mirror that of the Crow Butte Site, which states:

“The typical well casing used is rigid PVC Standard Dimension Ratio 17 (SDR-17) with a nominal 13 centimeters (5 inches) outside diameter (Certainteed or similar). However, should a larger pump size be required, larger diameter casing may be utilized.”

The hole will be cased with 12-inch steel surface casing outside nominal 5 to 6 inches diameter SDR-17 PVC well casing. Fiberglass or steel casing may also be used. The casing will extend from the top of the top of the target zone to approximately 2 feet above ground level. Each joint of SDR-17 casing will be connected by a water tight O-ring seal which is locked with a high strength nylon spline. No glue or screws will be used with these types of well casing materials.

The wells typically will be 4.5 to 6-inch nominal diameter and will meet or exceed the specifications of ASTM Standard F480 and NSF Standard 14. In order to provide an adequate annular seal, the drill hole diameter will be at least 2 inches larger than the outside diameter of the well casing.

The annulus materials will be emplaced using a tremie pipe and sealed with neat cement grout composed of sulfate- resistant Portland cement in accordance with Utah wells construction standards. Water used to make the cement grout will not contain oil or other organic material. Cement grout could contain adequate bentonite to maintain the cement in suspension in accordance with Halliburton cement tables.

Casing will be joined using methods recommended by the casing manufacturer. PVC casing joints approximately 20 feet apart will be joined mechanically (with a watertight O-ring seal and a high strength nylon spline) to ensure watertight joints above the perforations or screens. Casings and annular material will be routinely inspected and maintained throughout the operating life of the wells.

10.1.1 Thermoplastic Well Casing Variance Request

The Company requests a variance from the requirement in 40 CFR § 147.2104(b)(1) that plastic well casing materials, including PVC, ABS or others, not be used in new injection wells deeper than 500 feet in the State of Utah. This variance is requested on the following basis:

1. Collapse pressure calculations and well casing manufacturer specifications indicate that PVC well casing can be used at depths greater than 500 feet considering the site-specific well construction methods (see Section 11.1.1.1).
2. PVC well casing has been used successfully for wells deeper than 500 feet at other

ISR facilities for many years (see Section 11.1.1.2).

3. PVC well casing is commonly used for other wells in Utah deeper than 500 feet (see Section 11.1.1.3).
4. Thermoplastic well casing is the preferred well casing material for ISR facilities due to corrosion resistance. The corrosion resistance of PVC compared to carbon steel well casing is well documented.
5. Each new injection, production and monitor well will be pressure tested to confirm the integrity of the casing prior to being used for ISR operations. MIT will be repeated every 5 years and after any repair where a downhole drill bit or under-reaming tool is used (see Section 11.5).
6. The injection pressure for each injection well will be maintained below the maximum pressure rating of the well casing (see Section 7.2).
7. An extensive excursion monitoring program will be implemented by installing and sampling monitor wells in the perimeter of the production zone and in overlying and underlying hydrogeologic units to detect potential excursions of ISR solutions into USDWs such as would occur with a leaking injection well (see Section 14.2).
8. Injection pressures will be monitored through automated control and data recording systems that will include alarms and automatic controls to detect and control a potential release such as would occur through an injection well casing failure (see Section 14.1).

The variance is requested pursuant to 40 CFR § 147.2104(d)(4), which states that the Regional Administrator may approve alternate casing provided that the owner or operator demonstrates that such practices will adequately protect USDWs.

10.1.2 Hydraulic Collapse Pressure Calculations

When specifying well casing and installation, the Company will adhere to the requirements in ASTM F480, Standard Specifications for Thermoplastic Well Casing Pipe and Couplings Made in Standard Dimension Ratios (SDR), SCH 40 and SCH 80. ASTM F480 requires that “the depth at which thermoplastic well casing can be used is a design judgment.” There is no depth of installation limit in ASTM F480 except that PVC well casing should be “used under conditions that meet manufacturer’s recommendations for its type” and that “the driller shall install the thermoplastic casing in a manner that does not exceed the casing hydraulic collapse resistance.” In accordance with these requirements, the Company will ensure that all thermoplastic well casing meets the manufacturer’s recommendations for its type and is installed in a manner that does not exceed the hydraulic collapse resistance.

The net hydrostatic pressure on the well casing is calculated as the difference between the exterior and interior hydrostatic pressure. The hydrostatic pressure is calculated as the fluid density multiplied by the fluid depth. The Company will use cement to grout the annulus on all injection, production and monitor wells. Using a typical cement grout density of 90 lb/ft³, and recognizing that the inside of the well casing will always be full of water before the cement cures (with a density of at least 62.4 lb/ft³ depending on whether additives are used), the pressure versus depth gradient will be about 27.6 lb/ft³ or about 0.2

psi/ft of depth. According to CertainTeed (2011), the hydraulic collapse pressure for SDR 17 PVC well casing is about 224 psi. Therefore, it would take an installation depth much greater than 1,000 ft to exceed this pressure as long as cement grout is used and the well casing remains full until the cement hardens. Both of these conditions will be met in all injection, production and monitor well casing installations using the installation procedures described in Section 11.2. Water will be used to displace the cement and force it upward into the annulus; therefore, the well casing will always be full of water while the cement cures.

When designing and installing injection, production and monitor wells, the Company will adhere to the requirements of ASTM F480 and manufacturer's criteria to ensure that the installation does not exceed the casing hydraulic collapse resistance.

10.1.3 Use of PVC Well Casing at Other ISR Facilities

There are numerous successful applications of PVC well casing at other ISR projects where the well depths are in excess of 500 feet. For example, at the Crow Butte project, where the average ore depth is 650 feet, 4.5-inch ID PVC well casing has been successfully used for many years. Both Taseko Mines Ltd. and Excelsior Mining Corp.'s copper ISR projects are projected to use either PVC, FRP or fiberglass well casing as part of well design for wells ranging up to 600 feet deep or more (Gunnison NI 43-101, 2017 and Florence NI 43-101, 2017). Both copper ISR projects are located in Arizona.

10.1.4 Utah Well Construction Standards

UAC R317-7-10 provides the Utah State guidelines for the construction of Class III wells as would be installed for the Project. Specifically, the Utah well construction standards state:

All new Class III wells shall be cased and cemented to prevent the migration of fluids into or between underground sources of drinking water. The Director may waive the cementing requirement for new wells in existing projects or portions of existing projects where he has substantial evidence that no contamination of underground sources or drinking water would result. The casing and cement used in the construction of each newly drilled well shall be designed for the life expectancy of the well. In determining and specifying casing and cementing requirements, the following factors shall be considered:

- a. depth to the injection zone;
- b. injection pressure, external pressure, internal pressure, and axial loading;
- c. hole size;
- d. size and grade of all casing strings (wall thickness, diameter, nominal weight, length, joint specification, and construction material);
- e. corrosiveness of injected fluids and formation fluids;
- f. lithology of injection and confining zones; and
- g. type and grade of cement.

The Company will ensure that the Utah well construction standards are met during the engineering and installation of wells associated with the Project and will comply with UAC R317-7-10 monitoring requirements.

10.1.5 Compliance with 40 CFR § 146.32

The injection wells will comply with the 40 CFR § 146.32 regulations for protection of USDWs in Utah. The language stated in 40 CFR § 146.32 is a duplication of that found in the State of Utah R317-7-10.

10.2 Well Construction Methods

10.2.1 Injection Wells

Typical production and injection well installation will begin by drilling a bore hole through the ore zone to obtain a measurement of the copper grade and thickness. The ore depth is anticipated to range from approximately 200 to 900 feet. For all wells, the bore hole will be sampled and geologically logged. Samples will be collected at 5-10 ft intervals.

Injection wells will be constructed for use with packers. This will require a discontinuous screened interval and gravel pack separated by bentonite seals. A typical well is planned to have 4 to 8 20ft screened intervals separated by 5 ft intervals of blank casing. Casing centralizers will be installed as appropriate to allow uniform annular space. Gravel and bentonite will be tremied from the surface using separate gravel and bentonite tanks. The uppermost bentonite seal will extend a minimum of 10 feet above the uppermost screen. Following this the remaining annular space will be grouted to the surface using tremie pipe. Injection well design is shown on Figure 10.1. Injection wells

10.2.2 Extraction Wells

Extraction wells will be constructed with a continuous screened interval extending from the bottom of the well to a depth 10-20 feet below the top of the BC (Bed 15). The gravel pack will be tremied to a depth 10 feet above the top of screen. This will be followed with a minimum 10ft bentonite seal. The bentonite seal will be allowed to hydrate before grouting the well to surface. Extraction well design is shown on Figure 10.2.

10.3 Well Development

The primary goals of well development will be to allow formation water to enter the well screen, flush out drilling fluids, and remove the finer clays and silts to maximize flow from the formation through the well screen. This process is necessary to allow representative samples of groundwater to be collected, if applicable, and to ensure efficient injection and production operations. Wells will be developed immediately after construction using air lifting, swabbing, pumping or other accepted development techniques which will remove water and drilling fluids from the casing and borehole walls along the screened interval. Prior to obtaining baseline samples from monitor wells, additional well development will be conducted to ensure that representative formation water is sampled. The water will be pumped sufficiently to show stabilization of pH and conductivity values prior to sampling to indicate that development activities have been effective.

10.4 Well Rehabilitation

Extraction wells and injection wells may be rehabilitated over the course of mining in the event chemical precipitates affect yields. This will be conducted by acid-washing the screened intervals and reversing flows, and/or utilizing a work over drilling rig to surge and swab the wells using a surge block. Both injection and extraction wells are suitable submersible pump installation, acid washing and flows reversal. The primary goals of well rehabilitation will be to gently dissolve precipitates to open screened intervals and gravel pack.

Figure 10.1 Injection Well Construction Diagram

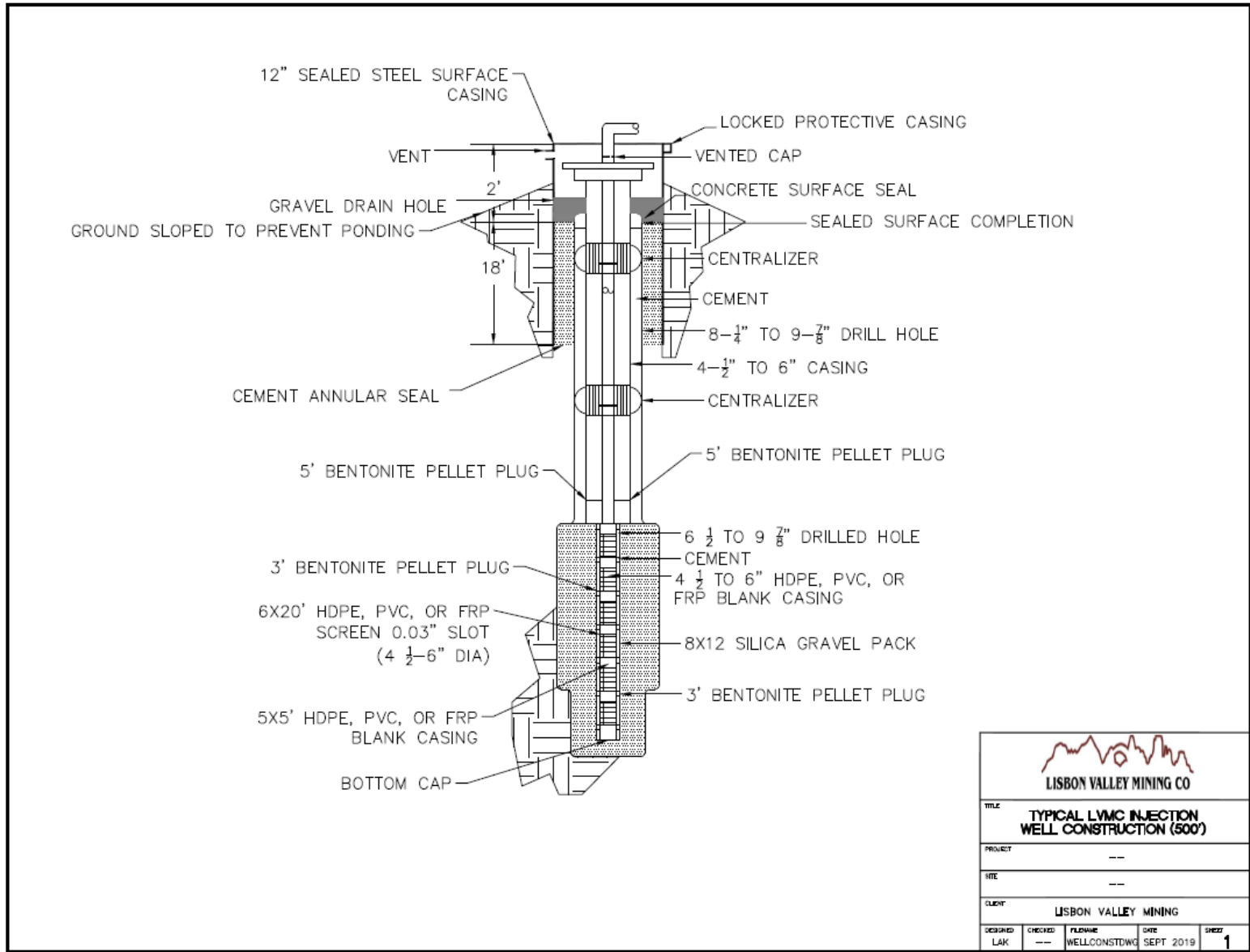

Figure 10.2 Production Well Construction Diagram

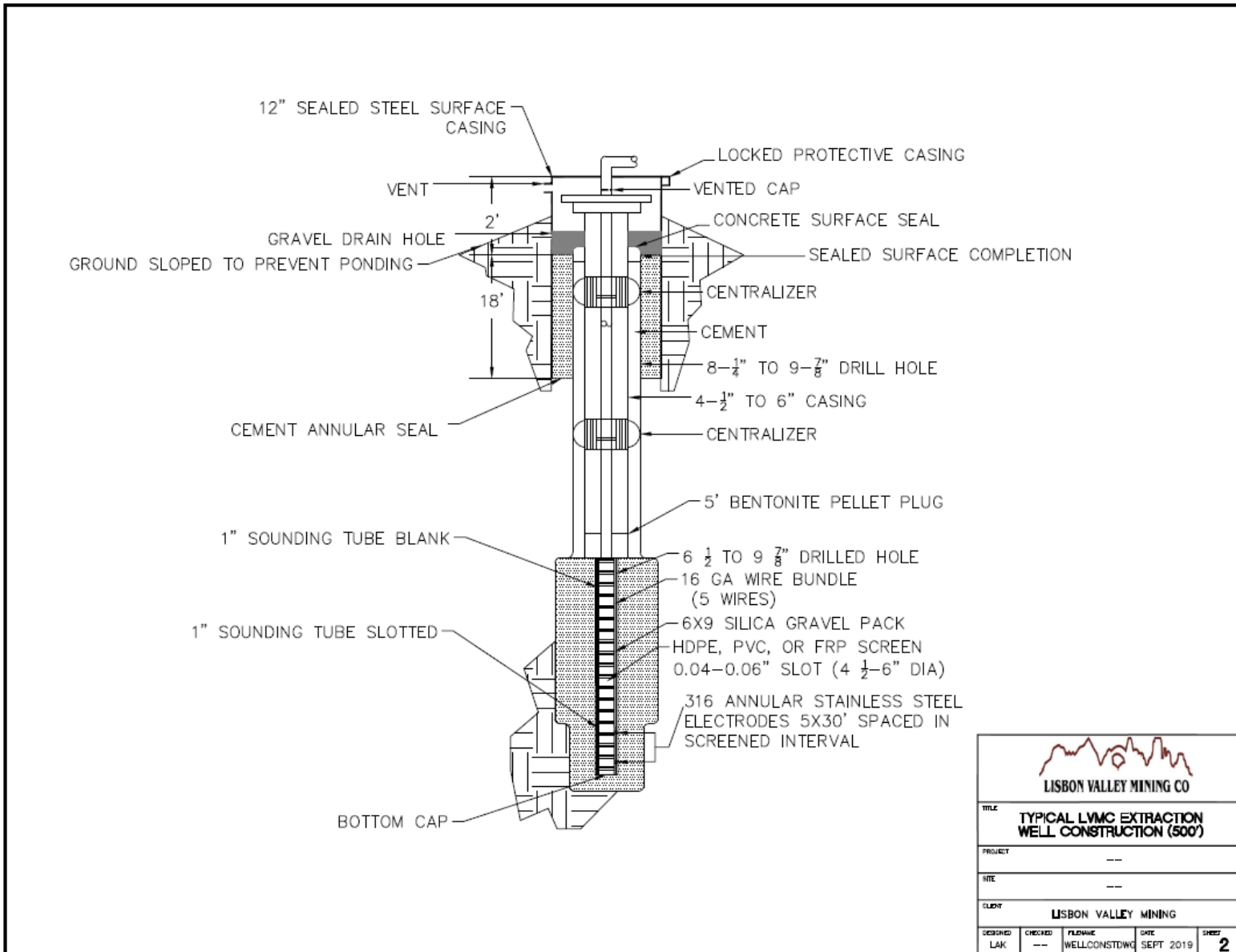
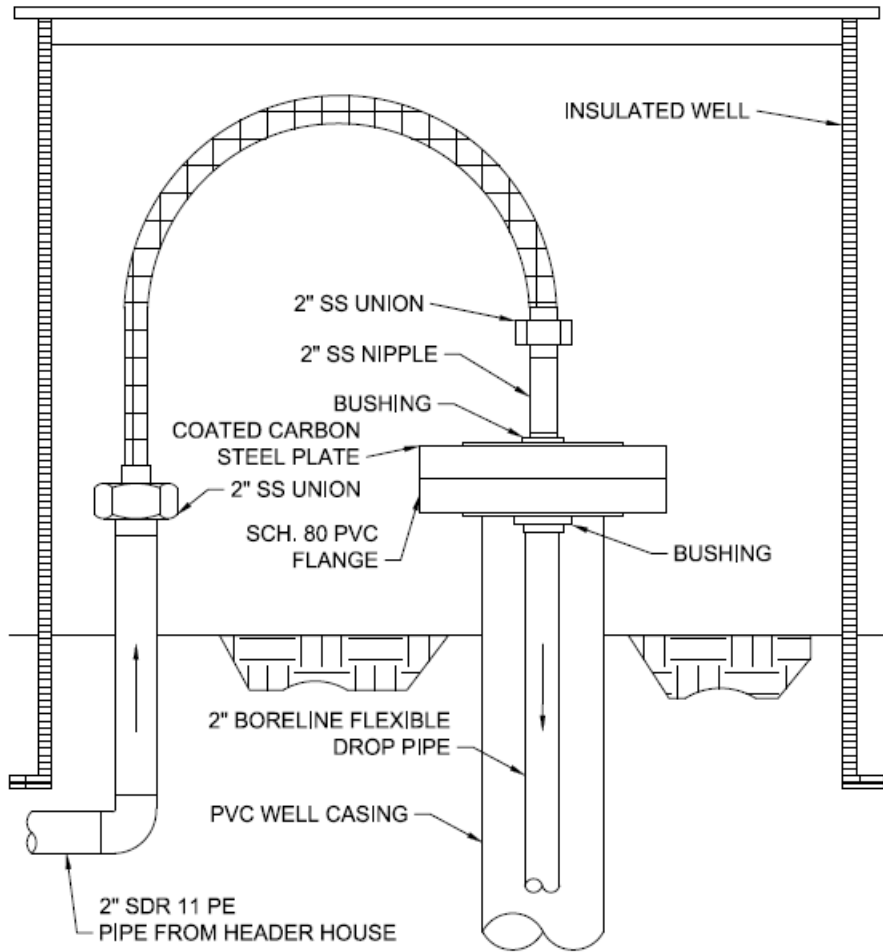



Figure 10.3 Injection Wellhead Construction Diagram





 LISBON VALLEY MINING CO				
TITLE				
TYPICAL INJECTION WELLHEAD LVMC				
PROJECT				

SITE				

CLIENT				
LISBON VALLEY MINING				
DESIGNED	CHECKED	FILENAME	DATE	SHEET
LAK	---	WELLCONSTDWG	SEPT 2019	3

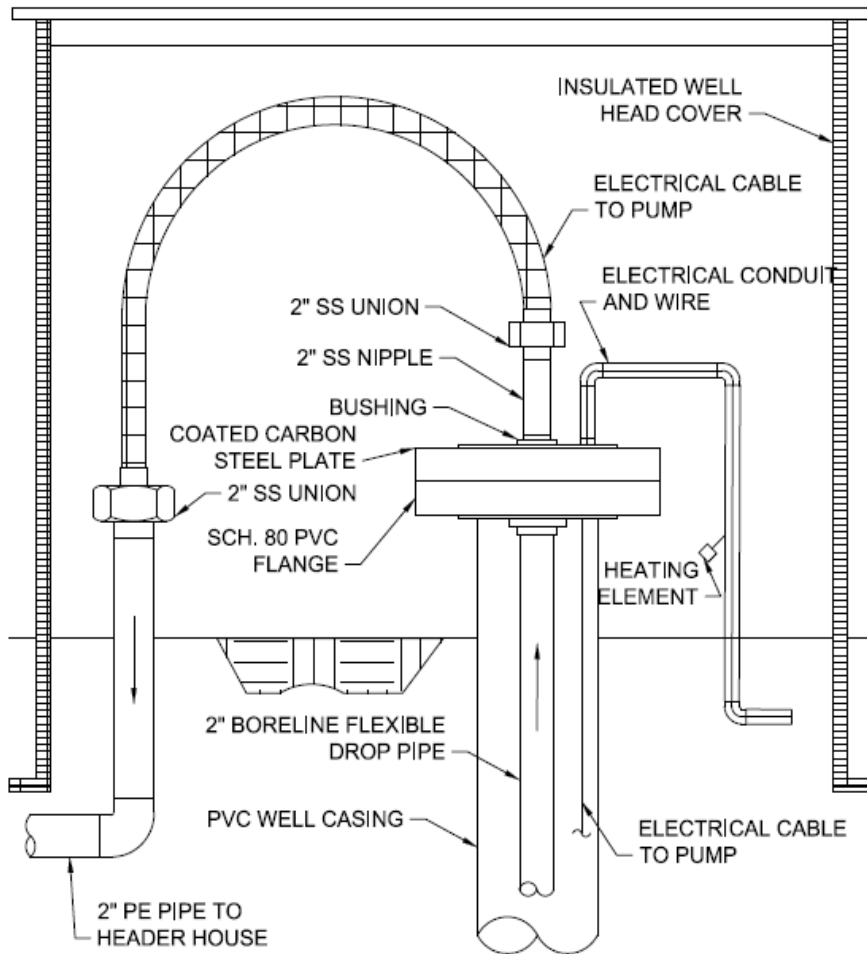
Figure 10.4 Production Wellhead Construction Diagram



 LISBON VALLEY MINING CO					
TITLE					
TYPICAL EXTRACTION WELLHEAD LVMC					
PROJECT					

SITE					

CLIENT					
LISBON VALLEY MINING					
DESIGNED	CHECKED	FILENAME	DATE	SHEET	
LAK	---	WELLCONSTDWG	SEPT 2019	4	

Attachment E

Injection Well Operating Plan and Procedures

11.0 PART I - Injection Well Operating Plan and Procedures

This attachment presents an overview of ISR operations, including injection procedures. It describes the general design of ISR well fields and specific design considerations. It also discusses hydraulic well field control, lined process ponds, groundwater restoration, and the project schedule.

11.1 Overview of Operations

The Project will implement ISR methods for copper extraction using existing process facilities and collection ponds and associated well fields for the first three deposits identified within the Project Area. These include GTO, Lone Wolf Deposits and Flying Diamond Deposits.

Copper will be recovered by injecting lixiviant fortified with oxygen into injection wells and recovering the resulting solution (pregnant lixiviant) from production wellfields. Copper solutions will be collected into three process collection ponds, a low copper grade solution collection pond (LLS), an intermediate copper grade solution collection pond (ILS), and high copper grade solution collection pond (PLS). The ILS collection pond will be used to recirculate ILS back through the deposit through injection to increase grade. When the ILS injection circuit reaches PLS concentration it will be redirected to the PLS collection pond. PLS will be piped to the Lisbon Valley Copper Mine and recovered via the Company's existing process facilities and solution will be returned to the well fields from the process facility collection ponds.

A fourth collection pond will be used for groundwater restoration at each deposit. It will be used to facilitate recirculation of groundwater from the mined-out areas of the wellfields. Restoration ponds will be plumbed to land application and/or wetland treatment cells. In addition, these ponds may be equipped with evaporation systems to concentrate TDS for deep well disposal.

The vast majority of water withdrawn from the production wells will be reinjected as part of the ISR process, such that the net withdrawal rate will be only a small fraction of the gross circulation rate. A small portion of the production and restoration streams will not be reinjected to maintain an inward hydraulic gradient within each well field for the duration of ISR mining and aquifer restoration activities.

Water for the ISR supply will be supplied from the BC aquifer to the extent possible. The BC aquifer is projected to be able to support ISR operations as well field operations are staged over time despite inconsistent productivity and presence throughout the Project Area. To the extent required, N aquifer water will be used to support ISR operations and also for BC aquifer restoration activity. Below is a schematic of the process flow.

Figure 11.1 Illustrative Flow diagram of the fluid flow associated with the ISR activities.

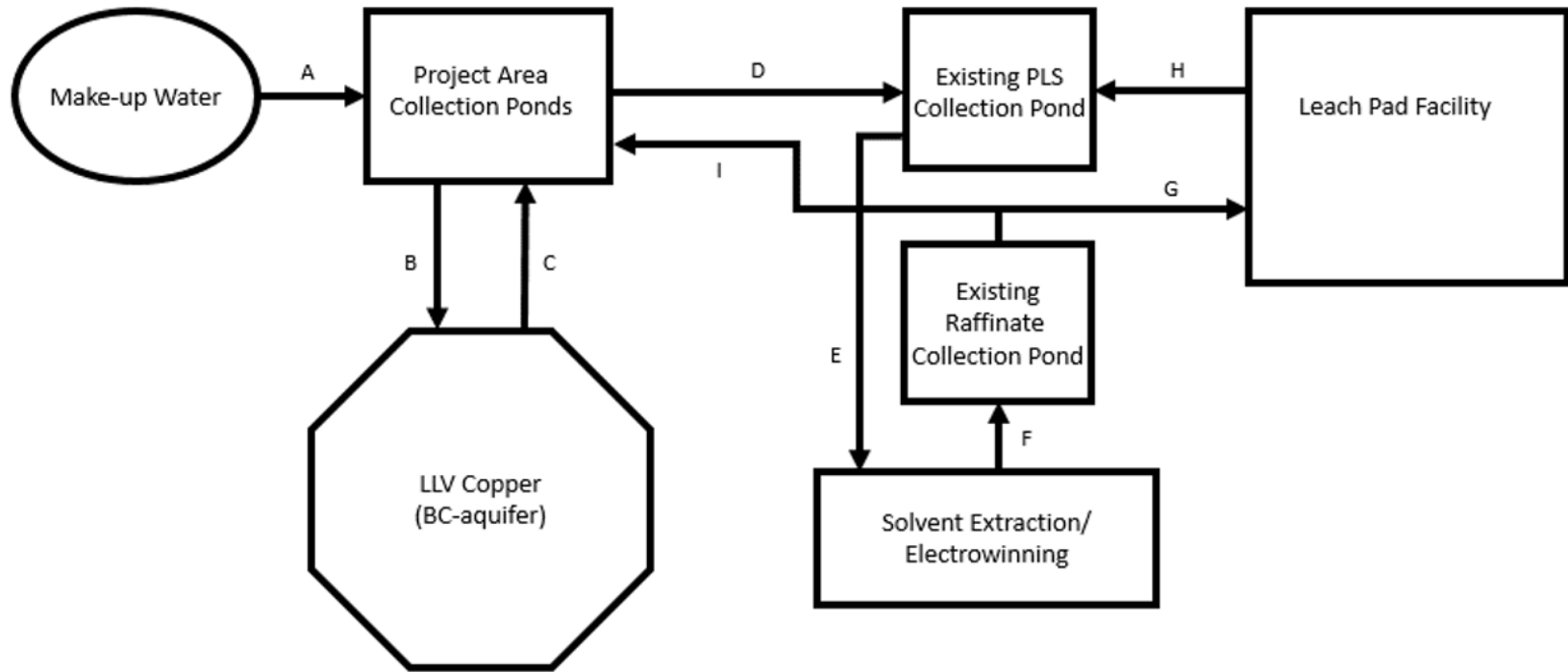

Stream ID	Description
A	Make-up water for leach operations
B	LLV injection
C	LLV extraction
D	Pregnant leach solution from ISR
E	Process plant feed
F	Copper barren solution to existing raffinate pond
G	Raffinate flow to existing heap leach operations
H	Pregnant leach solution from heap leach
I	Raffinate flow to ISR retention pond (Optional)

Monitoring systems will be implemented to ensure mining activities and changes in aquifer chemistry are contained to minimize potential impacts to the environment and public health. Monitoring systems will include both production wells and non-production wells along with related equipment to monitor groundwater chemistry in and surrounding the wellfields. Non-production monitoring wells will be equipped with pressure transducers prior to production. This will provide baseline information with which to correlate with ISR mining withdrawals, to further verify adequate confinement of mining fluids. Alert levels will be identified after production begins in accordance with pump testing at each wellfield for each monitoring well.

Aquifer restoration will be completed following copper recovery in each well field. During aquifer restoration, the groundwater in the well field will be restored in accordance with UDWQ requirements. Restoration will involve recirculation and rinsing the respective aquifers to restore a neutral pH and precipitate total dissolved solids (TDS). Final restoration may involve evaporation, land application, wetlands, and deep well injection.

A reclamation plan will be implemented in accordance with UDWQ permit and UDOGM large scale mine permit conditions to abandon wells, piping, wellfield controls, ancillary equipment, reclaim disturbed areas, and ensure that the Project Area meets all postmining land uses following ISR activities. See Section 14 for additional information.

11.2 Chemistry and Hydraulics of copper ISR

There are three primary components of successful copper ISR: i) mineral receptiveness to leaching or chemistry, ii) permeability of the host rock and iii) maintaining appropriate leaching conditions in the target ore zone.

The ISR process involves the oxidation and solubilization of copper sulfide minerals in-situ, meaning “in-place” using a leaching solution (lixiviant). The lixiviant will consist of groundwater, dilute sulfuric acid gaseous oxygen. The lixiviant will be circulated through the ore deposit to oxidize and dissolve copper minerals into a copper-bearing solution consistent with leaching chemistry used to leach ore from open pit mining. The chemistry of copper sulfide oxidation and dissolution is described below:

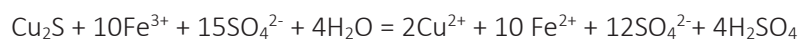

The Company will employ the iron based lixiviant where total iron and ferric iron levels are increased from baseline water level by lowering pH and adding dissolved air or oxygen. Ferric iron is the key leaching agent for copper mineralization at the LVMC and air or oxygen helps promote the amount of ferric iron in the leaching lixiviant. Copper recovery at Lisbon Valley has been approximately 65 – 75% using the same leaching chemistry over thirteen years in its open pit mining operations (this copper recovery chemistry is used throughout the copper industry).

Additionally, the Company has performed substantial column test work analyzing ISR copper chemistry in its laboratory which has confirmed 70% plus copper recovery which is commercially economic, an example of a set of column tests is show below in Figure 11.2. The Company has also performed confirmatory bench-scale core testing focused on copper recovery and rock permeability under anticipated operational pressures.

Figure 11.2 ISR Column Test Copper Recovery Relative to pH

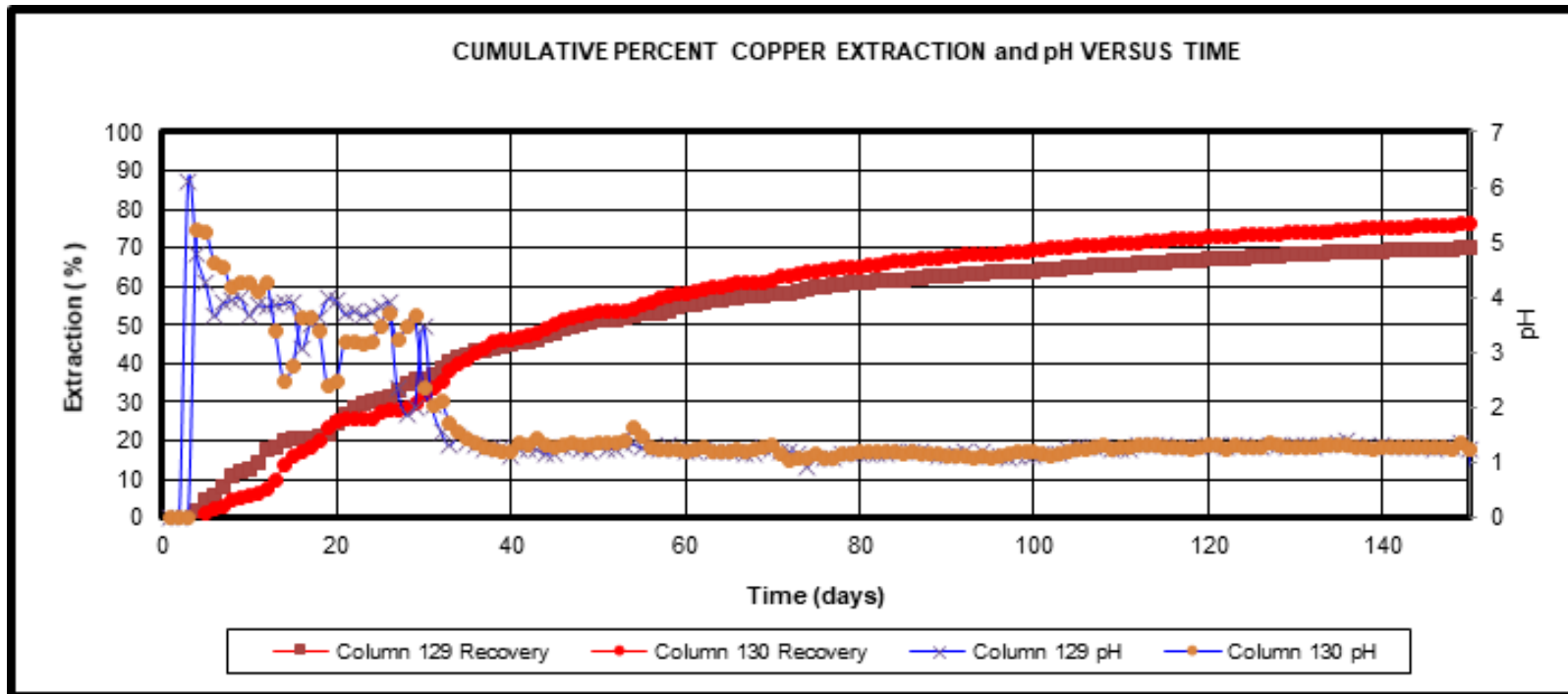

ISR requires permeable ore bodies to facilitate introduction and extraction of lixiviant. The Company has performed multiple comprehensive aquifer tests in addition to collection of thirteen years of groundwater quality data from the BC aquifer, all of which indicate permeability and chemistry supportive of the ISR. The Company projects ISR operational flow rates (Section 6.10) based on the Company's pump test as well as planned well and pump design. The fine dissemination of copper mineralization in the host sandstone is ideal for ISR which utilizes the sandstone's permeability to access fine copper mineralization with lixiviant for recovery.

The Company projects using a well packer system in order to control and monitor lixiviant sweep through the aquifer and related target zones. The Company has substantial operational and test data that support copper recovery when appropriate chemistry conditions are maintained under hydraulic pressure and flow. The Company projects using water from throughout the BC aquifer in the Project Area in order to support ISR required hydraulics and flow rates and may augment water usage with water from the N aquifer.

Finally, The Company already owns and operates an SX/EW processing facility and infrastructure that will be used to process copper bearing lixiviant from the ISR project into pure copper cathode identical to the Company's current finished copper product from open pit mining operations. The Company projects its ISR project to be commercially viable for approximately 28 years based on development of existing 508 million pounds of measured, indicated and inferred resources contained in three copper deposits, GTO, Lone Wolf and Flying Diamond plus additional resource potential associated with these deposits (LVMC, 2019). The Company maintains its copper resources in compliance with US and International Resource reporting standards.

11.3 Well Field Design

Each ISR well field will consist of a series of injection and production wells completed within the target mineralization zone. Prior to design and layout of the wells, the ore bodies will be delineated with exploration holes. These holes will be geologically logged and sampled. Before drilling, each injection and production well will be assigned lateral coordinates, a ground surface elevation, depth to top of screened interval, and length of screened interval.

Conventional ISR wellfield operation utilizes vertical injection wells and extraction wells in roughly orthogonal patterns. Figure 11.3 shows variations of ISR wellfield patterns. The Company intends to begin production using a conventional 5-spot pattern with wells spaced 150-ft. Other patterns will be considered and potentially implemented after the sweep efficiency of the initial 5-spot pattern is measured and evaluated.

Figure 11.3 Conventional ISR Patterns

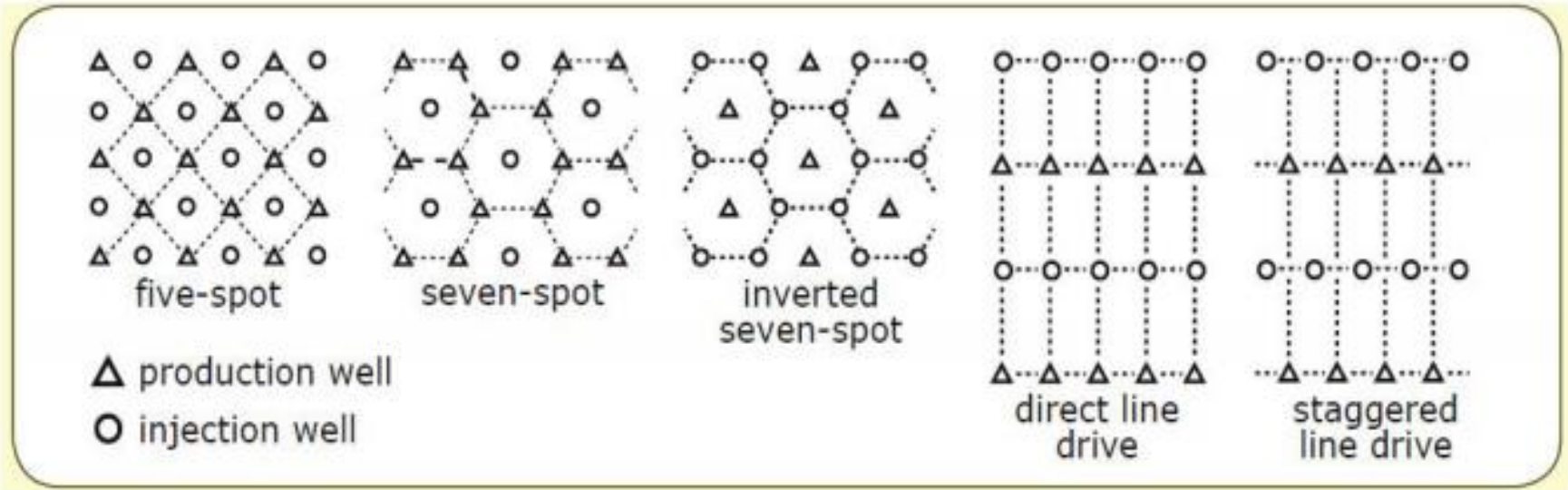

11.3.1 Injection and Production Wells

For all injection and production wells, the top of the screened interval will be at or below the base of the confining unit overlying the mineralized zone. The screened interval will be completed only across the targeted ore zone.

A typical (150 x 150 ft grid) well field layout is illustrated on 10.1. This typical layout is based on the lateral distribution and grade of the GTO copper deposit.

The well patterns and spacing may differ from well field to well field, but a typical pattern will consist of five wells, with one well in the center and four wells surrounding it oriented in four corners of a square. Typically, a production well will be located in the center of the pattern, and the four corner wells will be injection wells. Injection wells are further surrounded with monitoring wells. These wells are sequentially converted to extraction wells as the wellfield expands. This allows the configuration to support injection, extraction, and monitoring. Figure 11.4 depicts the proposed typical 5-spot well field pattern. It is important to note that the spacing and configuration can and will change in response to geologic structure and hydraulic continuity.

All wells will be completed for use as either injection or production wells, so that flow patterns can be changed as needed to recover copper and restore groundwater quality in the most efficient manner.

Figure 11.4 Proposed 5-Spot Wellfield Pattern and Production Zone Monitoring Wells

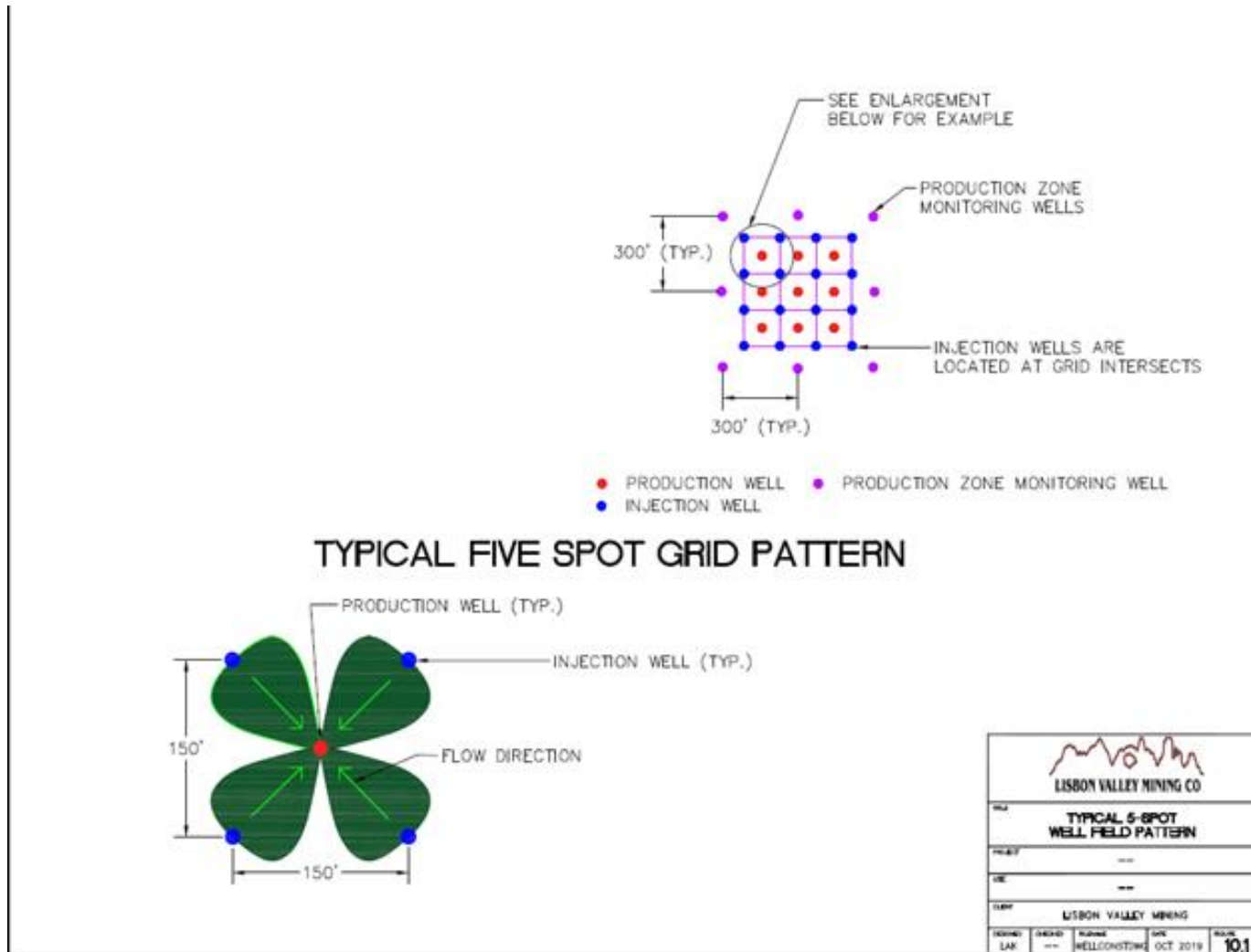

11.4 Wellfield Installation and Operation Sequence

ISR wellfields will be installed and sequenced along the long axis of each deposit in the Project Area. At each of the current deposits this will expand the wellfield in the NW/SE directions. The operation sequence will begin with mining and convert to restoration as well field rolls out. The Company intends to add approximately 200-250 wells/per year. Individual wells are intended to operate as mining wells for 5 years, or until they are no longer commercial. Following completion of copper recovery, a subset of the extraction wells will be converted to restoration and used to recirculate groundwater within the wellfield. This operational sequence allows for concurrent restoration of the aquifer. No well fields will interact with any domestic water wells.

11.4.1 Process Ponds

Each wellfield will be plumbed to the process ponds through a series of headers and common valving. The headers will direct wellfield flow to one of three ponds. All process and reclamation ponds are designed to contain 6MM gallons.

- Intermediate leachate solution (ILS)
- Pregnant leach solution (PLS)
- Reclamation pond
- Contingency pond(s)

Wellfield circulation will begin through the ILS pond. Here the ILS pond will serve to recirculate acid, water, and metals dissolved from the deposit through the respective wellfield until the copper grade approaches a commercial level (PLS). ILS pond solutions will be maintained at a prescribed pH through the addition of makeup acid. This process will continue for the duration of the commercial mining sequence.

As the copper concentration in the extraction wells approaches a commercial level, a fraction of the wellfield flow will be re-directed to the PLS pond. The PLS pond will be further concentrated through continued circulation of ILS through the wellfield. The PLS will be pumped to the Company's SX/EW plant at the Lisbon Valley Copper Mine through the ISR pipeline corridor. Here the SX/EW will extract the copper and recirculate the barren solution through the mine's raffinate pond. The raffinate from the beneficiation process will be pumped back to the ILS pond through the ISR wellfield corridor back to each wellfield for continued recirculation.

Aquifer restoration will begin after portions of the wellfield no longer produce commercial levels of copper. Barren wellfield flow will be redirected to the reclamation pond. Here the reclamation pond will be used to rinse and reclaim the water by continued circulation through barren portions of the wellfield without makeup acid. The absence of makeup acid will quickly consume the remaining acid and solids will precipitate back into the aquifer. Recirculation will continue until restoration standards are obtained, either through continued recirculation, land application, deep well disposal or combination of all.

11.4.2 Monitor Wells

Monitor wells will be installed in and around each well field to detect the potential migration of ISR solutions away from the target production zone. Perimeter monitor wells will be completed in the production zone around the perimeter of each well field. Non-production zone monitoring wells will be

completed within each well field in the adjacent and overlying and underlying aquifers. A detailed description of the monitor well design and sampling procedures is contained in Section 12.

11.4.3 Hydraulic Well Field Control

The Company will maintain hydraulic control of each well field from the first injection of lixiviant through the end of aquifer restoration. During copper recovery, the groundwater removal rate in each well field will exceed the lixiviant injection rate, creating an inward hydraulic gradient within each well field. During aquifer restoration, the groundwater removal rate in each well field will exceed the injection rate of permeate and clean makeup water from the BC or N aquifers. If there are any delays between copper recovery and aquifer restoration, production wells will continue to be operated as needed to maintain water levels within the perimeter monitor rings below baseline water levels. This activity may be intermittent or continuous.

Inward hydraulic gradients will be maintained and monitored through use of flow meters and wireless dataloggers at each wellfield. Flow meters will be installed at all extraction and injection wells to ensure extraction rates exceeds injection. Wireless pressure and conductivity dataloggers will be installed and operated in each perimeter production monitoring well surrounding each wellfield (see Fig 11.4). Pressure dataloggers will be monitored to verify an inward hydraulic gradient. Conductivity dataloggers will be monitored to detect any changes in conductivity indicative of lixiviant excursion. Both water levels and conductivity measurements will be conducted at a frequency appropriate to confirm hydraulic well field control as described in Section 14.2.3. In the event an excursion is detected, corrective action measures will be taken in accordance with Section 13.1.

Verification of hydraulic control will be performed through water level measurements in perimeter monitor wells and non-production monitoring wells. Water levels will be measured using pressure transducers or manual electronic meters and recorded at a frequency appropriate to confirm hydraulic well field control as described in Section 14.2.3.

11.5 Approach to Wellfield Control with Respect to Partially Saturated Conditions

Refer to Section 5.2.2.5 for a description of partially saturated conditions. The only instance where hydrologically unconfined (partially saturated) conditions exist within an area proposed for ISR operations occurs at the GTO deposit. The GTO deposit will be treated like a conventional saturated deposit however extraction wells will be located in the saturated portion of the deposit. Lixiviant injection will report to the saturated portion of the deposit as a function of geologic control features such as faults and impermeable layers.

11.6 Approach to Wellfield Control with Respect to Historical Mine Workings

As described in Section 3.2 the former Woods mine extracted ore from the Chinle Formation which borders the GTO deposit. All mining was done in the footwall and therefore remains hydraulically isolated from any potential ISR activities by the Flying Diamond Fault. A map of the historical Woods mine workings was shown on Figure 3.4. Hydraulic isolation of the historical mine workings has been demonstrated by pressure transducer monitoring in the workings (footwall) and in the Project Area (hanging wall). This was described previously in Section 7.2.3. Figure 11.5 shows the transducer testing results showing isolation of the historical mine workings.

There is one small existing open pit, GTO, in the Project Area. ISR operations target GTO ore will not have any operational relationship with the GTO pit or existing open pit operations.

If any additional open pits are mined in the Project Area, ISR may be used a complimentary copper recovery strategy however ISR solution will not interfere with any open pits. An open at a similar depth as the ore zone in the Project Area would create an influent hydraulic gradient toward the pit which would only further increase the control of the fluid flow in addition to well field hydraulic control. After open pit mining, open pits are backfilled eliminating the existence of pit pools so in addition to restoration of the BC aquifer, no BC aquifer water will pool anywhere in the Project Area.

Figure 11.5 Transducer Testing Woods Mine Area

Figure 11.5 shows the response of transducer testing across the Woods mine area. The transducer response supports the hydraulic isolation of the BC aquifer from the adjacent historical mine workings as a function of the Lisbon Valley fault dividing the two areas.

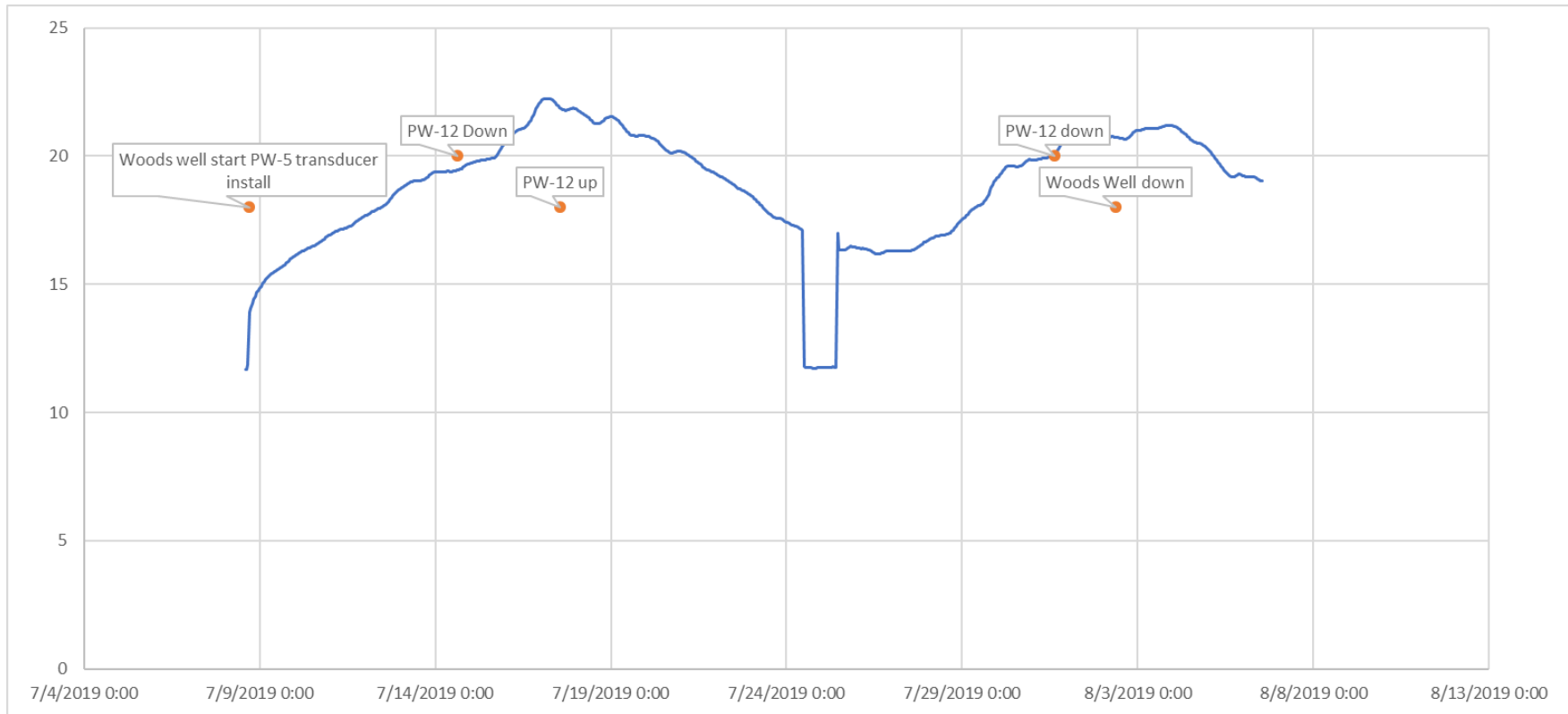

11.7 Groundwater Restoration

Groundwater restoration in each well field will be conducted in accordance with UDWQ Class III permit requirements. Per the UDWQ UIC Guidelines, the purpose of the Class III UIC Permit for which the Company is proposing, is to “inject fluids for the in situ extraction of minerals or metals from ore bodies that have not been previously mined by conventional methods.” (deq.utah.gov, 2020). As stated on the UDWQ UIC program, the purpose of a Class 5B6 well or wellfield is: “Subsurface Environmental Remediation – Used to clean up, treat, or prevent contamination of groundwater.”

Before and during the ongoing ISR operations, the Company will collect data in regard to baseline ground water quality, natural acid neutralization as a function of sweep, and other pertinent information that will be used to prepare a comprehensive Groundwater Restoration Plan.

11.7.1 Target Restoration Goals

Groundwater restoration, or aquifer restoration, will be performed pursuant to UDWQ requirements to protect USDWs. The groundwater restoration program for all well fields will be conducted pursuant to UAC R317-7.

Prior to operation, the baseline groundwater quality will be determined through the sampling and analysis of water quality indicator constituents in wells screened in the mineralized zone(s) across each well field. Section 12.2 describes the methods used to select baseline wells, sample the wells, and calculate baseline water quality statistics. The target restoration goals (TRGs) will be established as a function of the average baseline water quality and the variability in each parameter according to statistical methods approved by UDEQ.

11.7.2 Groundwater Restoration Process

Groundwater restoration will be conducted in accordance with UDWQ permit requirements in a manner that will protect USDWs, human health and the environment. The methods for achieving this objective are discussed in the following sections.

11.7.4 Groundwater Rinse and Neutralization

Closure of the wellfield will begin with include the elimination of make-up acid to the ILS pond. This will be followed by recirculation of the groundwater inside each wellfield. In general, recirculation will involve perimeter wells pumping to the interior of the wellfield. This approach recirculates groundwater within the wellfield and brings in fresh groundwater from the perimeter, effectively recirculating and rinsing the former copper deposit. Neutralization and TDS reduction will occur as a function of the highly calcic aquifer characteristics combined with the fact no additional acid is added. This water will be used for land application and evapo-concentrated or for deep well disposal, if either is necessary. Land application will include conventional irrigation of salt-tolerant plant species and/or wetland species. Figure 11.6 shows planned locations of land application. Rinsing, deep well disposal and land application will be continued until asymptotic TDS concentrations are identified, or as long as technically and economically feasible.

The Company shall monitor the rinsing progress by analyzing fluids recovered from all recovery wells in the first mine block after rinsing. This data will then be used to determine the minimum number of sampled wells needed to confirm that rinsing has been successful in the rinsing and closure of subsequent

mine blocks. The results of that evaluation shall be submitted for UDWQ review and approval. The wells to be retained for sampling during rinsing operations in subsequent mine blocks shall be identified and the locations of those wells shall be provided before closure of other wells in a mine block is approved by UDWQ.

11.7.5 Land Application Option

In the land application liquid waste disposal option, the primary method of aquifer restoration will be incremental groundwater circulation and rinse followed by land application. Land application will include surface irrigation via 300-1000ft pivots and/or engineered wetlands. Wetlands will require permitting through US Corp of Engineers. Land application targets are shown on Figure 11.6.

11.7.6 Deep Disposal Well Option

In the deep disposal well option the primary method of aquifer restoration will be incremental groundwater circulation and rinse followed by deep well disposal in an existing Class III Disposal Well. Deep well disposal is shown on Figure 11.7.

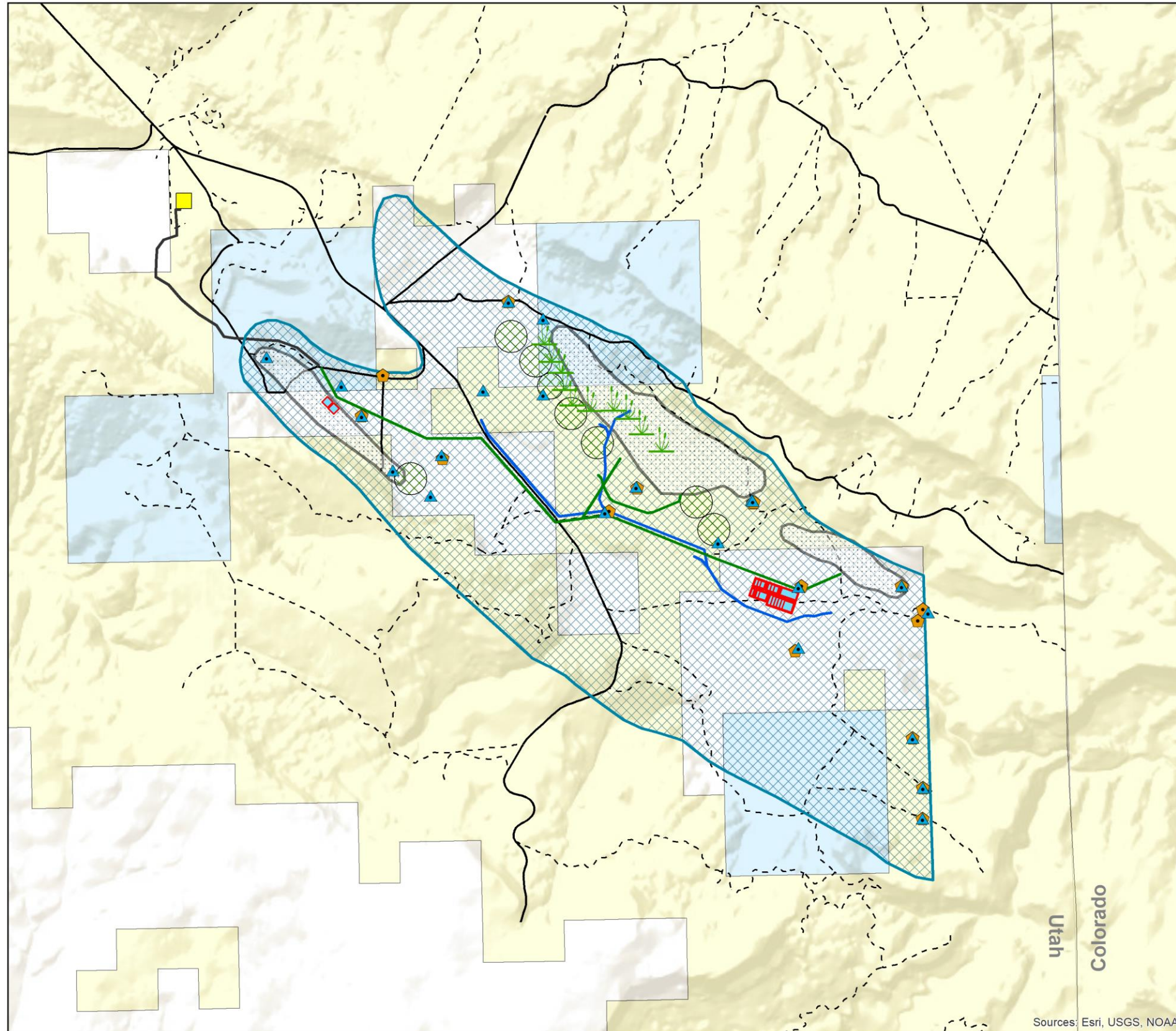

Legend

- Aquifer Exemption Boundary
- Project Area
- BC Aquifer Monitoring Wells
- Morrison Fm and N Aquifer Monitoring Wells
- Wetland Engineering Target
- Mine Area Pipeline Corridor
- Access Roads, Pipelines, Overhead Power
- Drainage Channel
- ISR Process Ponds
- Processing Plant SXEW
- Land Application
- San Juan Co B Roads
- San Juan Co D Roads
- Federal BLM Land
- Private Land
- State Trust Land

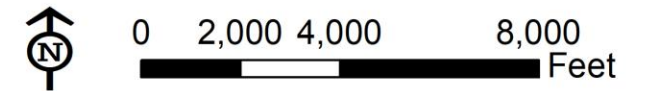
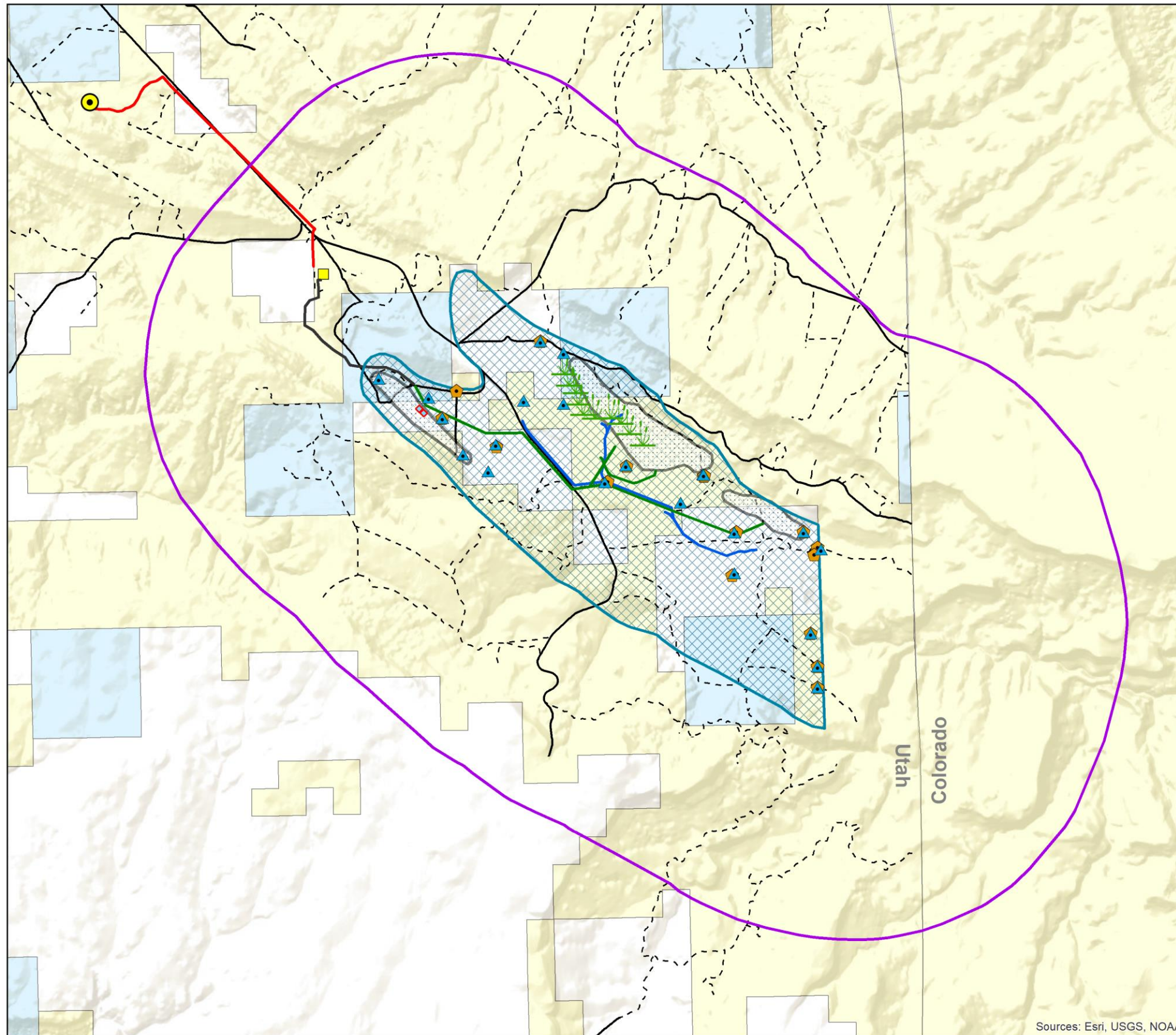

Figure 11.6
Proposed Facilities and Initial Well Areas
Land Application Option
 Lower Lisbon Valley Project

Drawn By: Brian Sparks Date: 24 June 2020

File Name: ISR Figure 11.6 Proposed Facilities Land Application





Legend

- Aquifer Exemption Boundary
- 2 mi AOR
- ▲ BC Aquifer Monitoring
- Morrison Fm and N Aquifer Monitoring Wells
- 🌿 Wetland Engineering Target
- Mine Area Pipeline
- Access Roads, Pipelines, Overhead Power
- Deep Disposal Well
- Deep Well Disposal Piping
- Drainage Channel
- ISR Process Ponds
- Processing Plant SXEW
- Federal BLM Land
- Private Land
- State Trust Land
- Project Area



Figure 11.7
Proposed Facilities and Initial Well Areas
Deep Disposal Well Option
 Lower Lisbon Valley Project

Drawn By: Brian Sparks	Date: 24 June 2020
------------------------	--------------------

File Name: ISR Figure 11.7 Proposed Facilities Deep Disposal Well

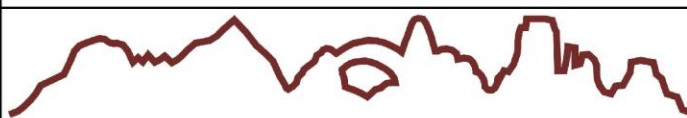

LISBON VALLEY MINING CO

11.7.7 Groundwater Restoration Monitoring

Groundwater restoration monitoring will be conducted quarterly during the restoration process and continue for 2 years after restoration is complete (post-rinse monitoring) in accordance with UDWQ requirements. Post-rinse monitoring may be extended to a longer term dependent on monitoring results and UDWQ interpretation.

The Company will submit a post-rinsing notification and report, with documentation, to UDWQ within thirty (30) days following completion of the post rinsing monitoring program.

11.8 Stormwater Control and Mitigation

The Company has evaluated flood inundation boundaries and will construct ISR facilities outside of these boundaries to avoid potential impacts to facilities from flooding and potential impacts to the surface in the event of any potential spills or leaks.

The Company has completed surface flow modeling to calculate peak discharges, and HEC-RAS models were used to compute water-surface profiles and inundated areas during runoff events. The results of this modeling were used to engineer drainage around all LLV mining facilities including ISR and open pit. All facilities will be located out of the 100-year flood inundation boundaries. Final design is subject to federal jurisdiction under Section 404 of the Clean Water Act (CWA). The drainage design concept is depicted in Figures 11.7 and 11.8 and detailed in Appendix J.

11.9 Schedule

Construction of ISR wellfields and facilities will begin at the GTO followed by Lone Wolf Deposit following the issuance of an UDOGM ISR mine permit, UDWQ Class III UIC permit, EPA aquifer exemption permit and other relevant permits. It is anticipated that construction of the second well field, GTO, and ancillary facilities will occur at the same time or follow shortly thereafter. Alternately, the Company may develop either the GTO or Lone Wolf area well fields first, followed by the well fields in the other area. Copper recovery operations within the permit area will continue for approximately 7 to 20 years during which additional well fields will be completed. Each well field will be decommissioned and plugged and abandoned when copper recovery is complete.

LVMC projects plugging and abandonment activity to begin approximately five years after ISR operations commence and continue annually until all well fields have completed copper recovery and been decommissioned. This will have the effect of keeping total wells requiring plugging and abandonment at a relatively static level after five years as new ISR wells are drilled and older ISR wells are decommissioned. It is likely that the process facilities will continue to operate for several years following decommissioning of the well fields. The entire Project will then be decommissioned and reclaimed in accordance with UDEQ, EPA, BLM and requirements. The projected construction, operation, restoration and decommissioning schedule is provided in Figure 11.8.

Figure 11.8 LVMC ISR Project Schedule

	Y1	Y2	Y3	Y4	Y5	Y6	Y7	Y8	Y9	Y10	Y11	Y12	Y13	Y14	Y15	Y16	Y17	Y18	Y19	Y20	Y21	Y22	Y23	Y24	Y25	Y26	Y27	Y28
Permitting/Licensing	█																											
Five spot test - GTO		█																										
Exploration/Development drilling - GTO		█	█	█	█																							
Injection Well field construction - GTO			16	25	33	33	33	33	33	33																		
Production Well field construction - GTO			10	15	20	20	20	20	20	20																		
Copper Production - GTO		█	█	█	█	█	█	█	█	█	█	█	█	█	█	█	█	█	█	█	█	█	█	█	█	█	█	█
Exploration/Development drilling - FD/LW				█	█	█																						
Five spot test - FD/LW					█																							
Injection Well field construction - FD/LW						28	33	50	67	100	133	133	133	133	133	133	133	133	133	77								
Production Well field construction - FD/LW						10	20	30	40	60	80	80	80	80	80	80	80	80	80	46								
Copper Production - FD/LW						█	█	█	█	█	█	█	█	█	█	█	█	█	█	█	█	█	█	█	█	█	█	█
Well Field Restoration Rinsing						█	█	█	█	█	█	█	█	█	█	█	█	█	█	█	█	█	█	█	█	█	█	█
Regulatory Approval of restoration						█	█	█	█	█	█	█	█	█	█	█	█	█	█	█	█	█	█	█	█	█	█	█
Well Field Plugging and Abandonment							5	26	40	53	91	106	133	160	213	213	213	213	213	213	213	213	213	213	123			
Well Field Stability Monitoring		█	█	█	█	█	█	█	█	█	█	█	█	█	█	█	█	█	█	█	█	█	█	█	█	█	█	█
Well field decommissioning																												
Facility decommissioning																												█

Attachment F

Monitoring, Recording, and Reporting Plan

12.0 PART J - Monitoring, Recording and Reporting Plan

This attachment describes the monitoring programs directly related to the proposed Class III UIC permit, including monitoring the pressure, flow rate and chemical characteristics of the injection fluid. It also describes monitoring programs that will be conducted in accordance with UDWQ permit requirements designed to protect groundwater quality outside of the exempted aquifer. These programs include excursion monitoring at POC wells surrounding each ISR wellfield. These programs are a supplement to the natural hydrologic confinement of the BC aquifer to LLV and from the N aquifer.

12.1 ISR Facility Monitoring

The Company will implement control and data recording systems at the ISR facilities which will provide centralized monitoring and control of the process variables including the flow rate and pressure of the injection stream at each wellfield. Pressure gauges installed at each injection wellhead or in the injection manifold also will be manually recorded at least daily.

The volumetric flow rate of oxygen will be measured at the point of injection into the barren lixiviant using calibrated gas flow meters. The flow meters will be routinely calibrated according to manufacturer recommendations.

The injection fluid in each operating well field will be sampled monthly. Samples will be collected from the ILS process pond and analyzed for copper, sulfuric acid, pH, total iron, ferrous iron, ferric iron, and Eh.

ISR facility monitoring will include subsidence monitoring of selected extraction wells in each wellfield. In addition to visual wellhead observations, this will include installation of a continuous GPS (CGPS) system at each of the three deposits, GTO, Lone Wolf, and Flying Diamond. CGPS sub-centimeter capabilities will be correlated with groundwater elevation measurements to evaluate any changes in surface subsidence.

12.2 Point of Compliance Monitoring

Following is a brief summary of the point of compliance monitoring program that will be conducted in accordance with UDWQ permit requirements to detect potential horizontal or vertical exceedance of two or more control limits of N aquifer water and BC aquifer water outside the well fields.

As is currently implemented by the Company for the Active Mine Area, the Company will monitor point of compliance (POC) wells associated with ISR activities. As described above, prior to commencement of ISR activities, baseline water quality data for the BC and N aquifers in the areas surrounding the proposed ISR wellfields will be determined. The baseline water quality data will be used to build a ground water protection level database. The ground water protection level to which the Company will monitor will consist of a mixture of Utah Drinking Water Quality Standards and site-specific standards. The higher of the two standards will be used as the ground water protection level.

The Company will monitor ground water on a quarterly basis during active ISR operations. While performing monitoring activities, the ground water chemistry will be tracked and measured against the ground water protection levels. Exceedance of the ground water protection limit shall occur if:

1. For parameters that have been defined as detectable in the background and for which protection levels have been established based on 1.5 times the mean background concentration,

exceedance shall be defined as two consecutive samples exceeding the protection level and the mean background concentration by two standard deviations.

2. For parameters that have been defined as detectable in the background and for which protection levels have been established based on 0.5 times the ground water quality standard, exceedance shall be defined as 2 consecutive samples exceeding the protection level and the mean background concentration by two standard deviations.
3. For parameters that have background data set between 50-85% non-detectable analyses, exceedance shall be defined as 2 consecutive samples from a compliance monitoring point exceeding the established protection level.
4. For parameters that have been defined non-detectable in the background and for which protection levels have been determined based on 0.5 times the ground water quality standard or the limit of detection exceedance shall be defined as 2 consecutive samples from a compliance monitoring point exceeding the established protection limit.

Upon determination of an exceedance ground water quality standards, the Company shall:

1. Verbally notify the Director of the exceedance within 24 hours of receipt of data, and
2. Provide written notice within 5 days of determination, and
3. Continue an accelerated schedule of monthly ground water monitoring for at least two months and continue monthly monitoring until the operation is brought into compliance.

12.2.1 Monitoring Network Design

The monitoring network will consist of production and non-production monitoring wells. Production monitor wells are part of each ISR wellfield as shown on Figure 11.2. These wells will be monitored to support to ensure inward hydraulic gradients at each wellfield and to detect lixiviant excursion. Water levels will be measured using downhole pressure transducers or manual electronic meters. These measurements will alert operators to any significant change in the water levels that would affect hydraulic control of lixiviants.

POC wells are located outside each wellfield and are monitored to detect changes in groundwater chemistry in the BC, M and N aquifers outside and below the respective wellfields, as well as outside the Project Area. A schematic of this plan is shown on Figure 12.1.

Figure 12.1 Point of Compliance Monitor Well Network Design

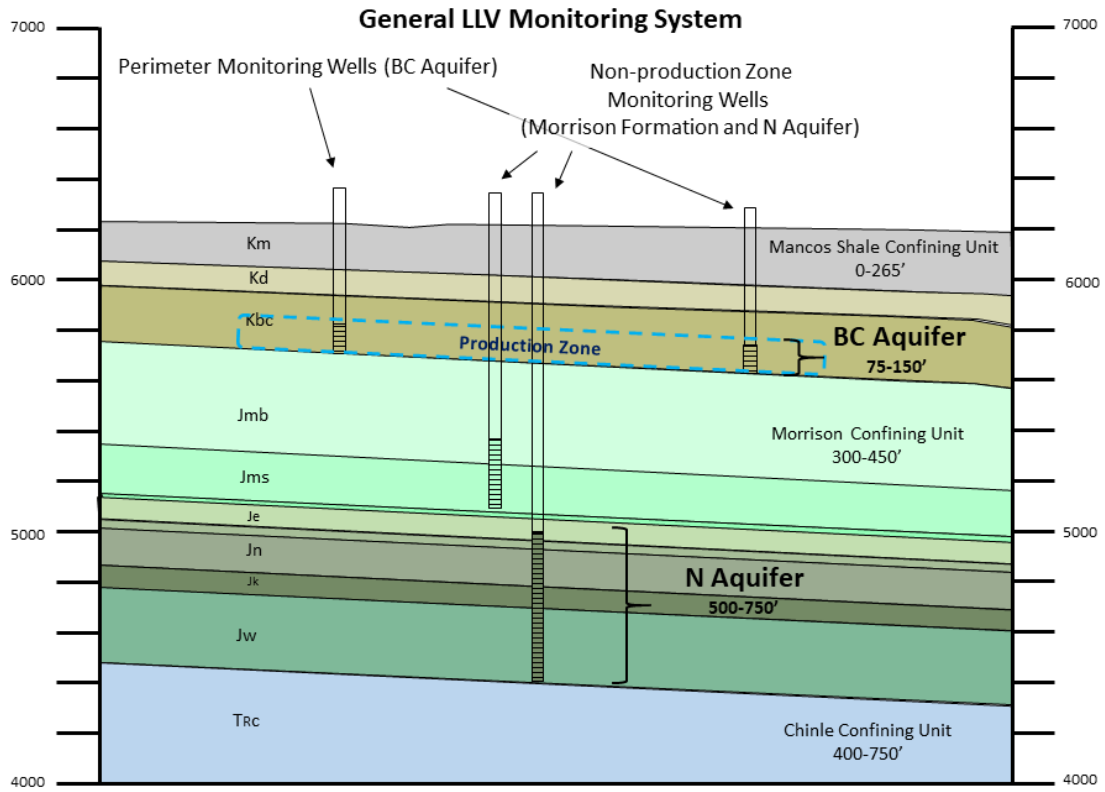

12.2.2 Point of Compliance Monitoring Wells

A total of 40 POC monitoring well locations have been identified. Six of the proposed monitoring wells already exist. The monitoring wells are configured in two perimeters, and will be monitored in two phases as necessary. The perimeter 1 (phase 1) are located approximately 1,000 ft outside each well field. The perimeter 1 monitor well configuration will be drilled and an enhanced baseline water quality monitoring program implemented prior to commencement of any ISR activities within the corresponding well field. The enhanced baseline water quality monitoring will provide the baseline data for the purposes of monitoring potential changes in ground water quality, as lined out in Section 12.2 above.

Perimeter 2 (phase 2) wells are located an additional 1,000 feet laterally. Perimeter 2 wells will be drilled (if not already in place) upon indication of an exceedance in any Perimeter 1 monitor well. Each active monitoring well will be sampled quarterly.

In accordance with Section 12.2, if an exceedance is detected in a phase 1 monitoring well, phase 2 wells in the same area will be installed or activated. Figure 12.2 shows proposed locations of all POC monitoring wells. Locations, depths, and formations are tabulated in Table 12.1.

Table 12.1 Proposed Monitoring Wells

Phase 1 Well	Easting	Northing	Depth	Well Type	Formation
FD BC P1-1	668,990	4,219,650	600	Piezo	BC
FD BC P1-2	670,270	4,219,400	600	Piezo	BC
GTO BC P1-1	663,740	4,221,920	700	Piezo	BC
GTO BC P1-2	664,480	4,221,640	700	Piezo	BC
LW BC P1-1	666,470	4,222,300	600	Piezo	BC
LW BC P1-2	666,470	4,221,550	600	Piezo	BC
LW BC P1-3	667,390	4,220,640	600	Piezo	BC
LW BC P1-4	668,540	4,220,500	600	Piezo	BC
PW-12	664,680	4,221,340	1000	Production	BC
PW-5	664,989	4,220,802	650	Production	BC
FD N P1-1	668,540	4,220,480	800	Piezo	N
FD M P1-1	668,540	4,220,480	600	Piezo	M
FD N P1-2	669,020	4,219,660	1500	Piezo	N
FD M P1-2	669,020	4,219,660	1300	Piezo	M
FD N P1-3	670,220	4,219,430	800	Piezo	N
FD M P1-3	670,220	4,219,430	600	Piezo	M
FD N P1-4	669,530	4,220,140	800	Piezo	N
GTO N P1-1	664,680	4,221,340	1500	Piezo	N
GTO M P1-1	664,680	4,221,340	1300	Piezo	M
LV 463-79	664,710	4,220,620	750	Piezo	N
LW N P1-1	666,470	4,222,300	800	Piezo	N
LW N P1-2	667,400	4,220,630	1500	Piezo	N
LW M P1-2	667,400	4,220,630	1300	Piezo	M
LW N P1-3	668,550	4,220,490	800	Piezo	N
LW M P1-3	668,550	4,220,490	600	Piezo	M
LW N P1-4	668,290	4,221,080	800	Piezo	N
LW N P1-5	667,280	4,221,880	800	Piezo	N
MW97-11	663,738	4,222,810	1500	Piezo	N
PW-11	666,487	4,221,512	1800	Production	N

Phase 2 Well	Easting	Northing	Depth	Well Type	Formation
GTO BC P2-1	665,360	4220 550	700	Piezo	BC
GTO BC P2-2	665,470	4,220,950	700	Piezo	BC
LW BC P2-1	666,130	4,220,470	700	Piezo	BC
LW BC P2-2	667,080	4,220,390	700	Piezo	BC
LW BC P2-3	668,530	4,220,510	700	Piezo	BC
LW BC P2-4	668,200	4,220,090	700	Piezo	BC
LW BC P2-5	665,880	4,221,592	700	Piezo	BC
FD BC P2-1	668,990	4,219,050	700	Piezo	BC
FD BC P2-2	670,500	4,219,280	702	Piezo	BC
LV41-75	664,810	4,220,340	750	Open Hole	N
GTO N P2-1	665,480	4,220,920	1500	Piezo	N
GTO M P2-1	665,480	4,220,920	1300	Piezo	M
GTO N P2-2	664,890	4,221,740	1500	Piezo	N
GTO M P2-2	664,890	4,221,740	1300	Piezo	M
PW-7	665,537	4,221,361	1501	Production	N
LW N P2-1	666,130	4,222,470	800	Piezo	N
LW M P2-1	666,130	4,222,470	600	Piezo	M
LW N P2-2	667,120	4,220,400	1500	Piezo	N
LW M P2-2	667,120	4,220,400	1300	Piezo	M
LW N P2-3	668,010	4,221,860	1000	Piezo	N
MW97-13	665,880	4,221,592	1500	Piezo	N
FD N P2-1	668,960	4,219,020	1500	Piezo	N
FD M P2-1	668,960	4,219,020	1300	Piezo	M
FD N P2-2	670,590	4,219,340	800	Piezo	N
FD M P2-2	670,590	4,219,340	600	Piezo	M
FD N P2-3	670,000	4,220,530	1200	Piezo	N

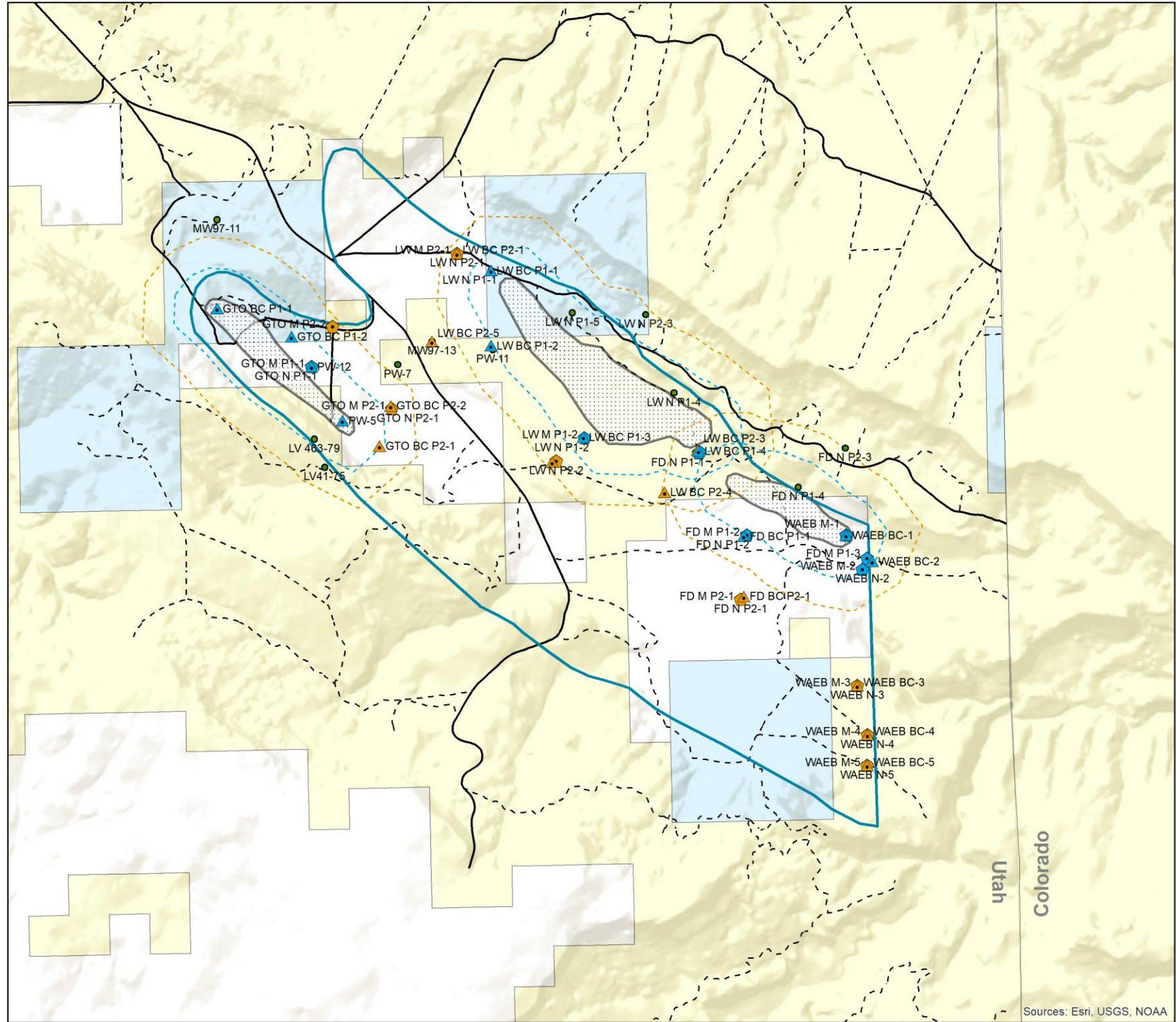

Legend

- ▲ BC Aquifer P-1 Monitoring Wells
- ▲ BC Aquifer P-2 Monitoring Wells
- ◆ Morrison Fm and N Aquifer P-1 Monitoring Wells
- ◆ Morrison Fm and N Aquifer P-2 Monitoring Wells
- Aquifer Exemption Boundary
- ISR Well Fields
- P-1 1,000' Boundary
- P-2 2,000' Boundary
- San Juan Co B Roads
- - - San Juan Co D Roads
- Federal BLM Land
- Private Land
- State Trust Land

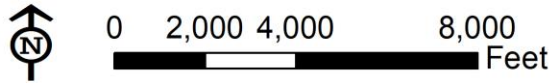

Figure 12.2
Existing and Proposed
Monitoring Wells
Lower Lisbon Valley Project

Drawn By: Brian Sparks	Date: 24 June 2020
File Name: ISR Figure 12.2 Proposed Monitoring Wells	

LISBON VALLEY MINING CO

12.2.3 POC Monitor Well Concept

As introduced in Section 12.1, POC monitoring wells will be located outside each wellfield in both BC and N Aquifers. The BC Aquifer will be monitored by BC wells surrounding each wellfield. The N Aquifer will be monitored by N Aquifer wells which both surround and underly each wellfield. Section-view examples of N Aquifer POC monitor wells around each copper deposit are shown on Figures 12.3-12.6.

Figures 12.3 and 12.4 Monitoring Well Cross-Sectional Layout at GTO Deposit and Lone Wolf Deposit NW

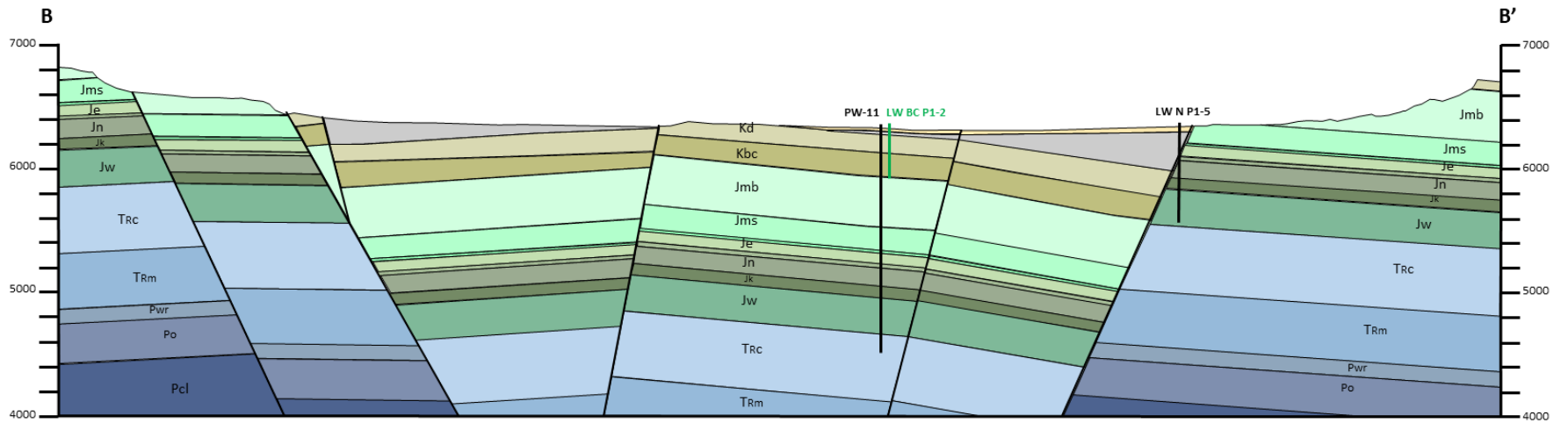
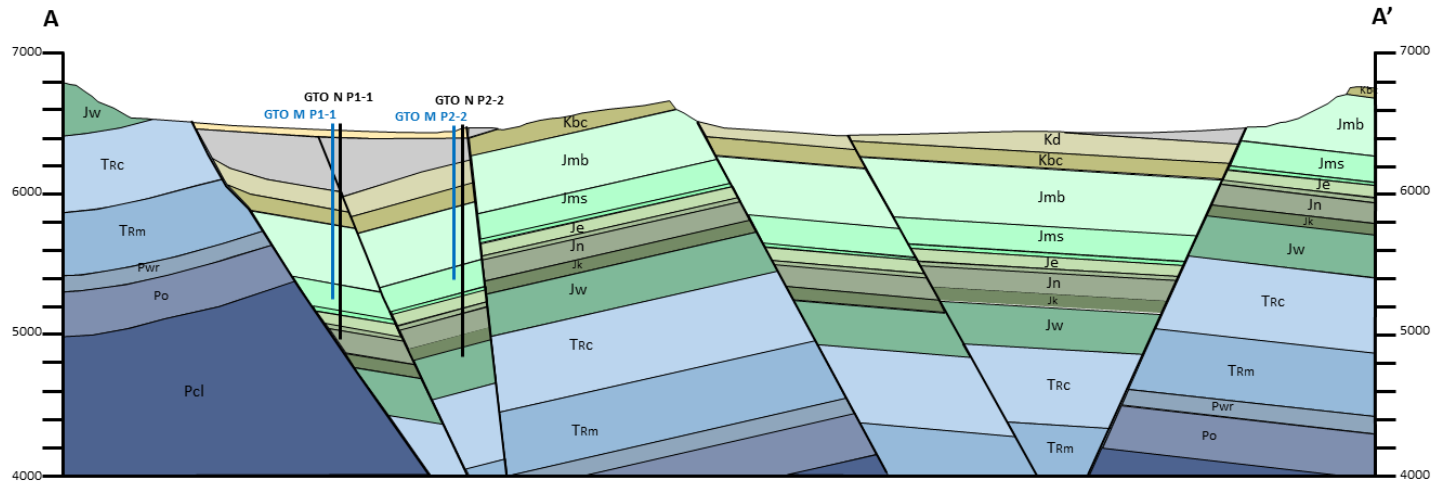

Figures 12.5 and 12.6 Monitoring Well Cross-Sectional Layout Lone Wolf Deposit SE and Flying Diamond Deposit

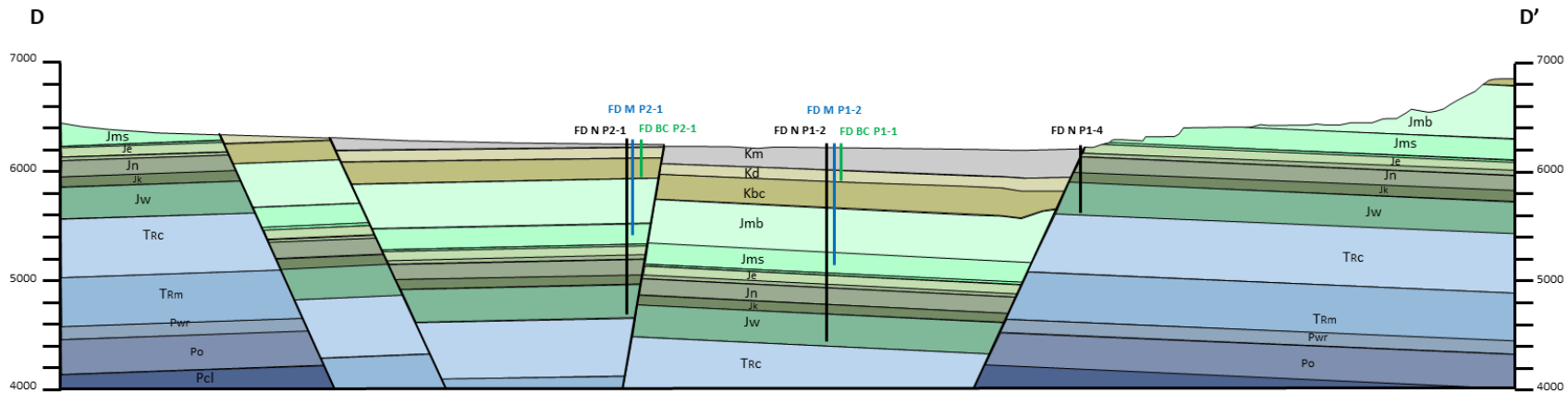
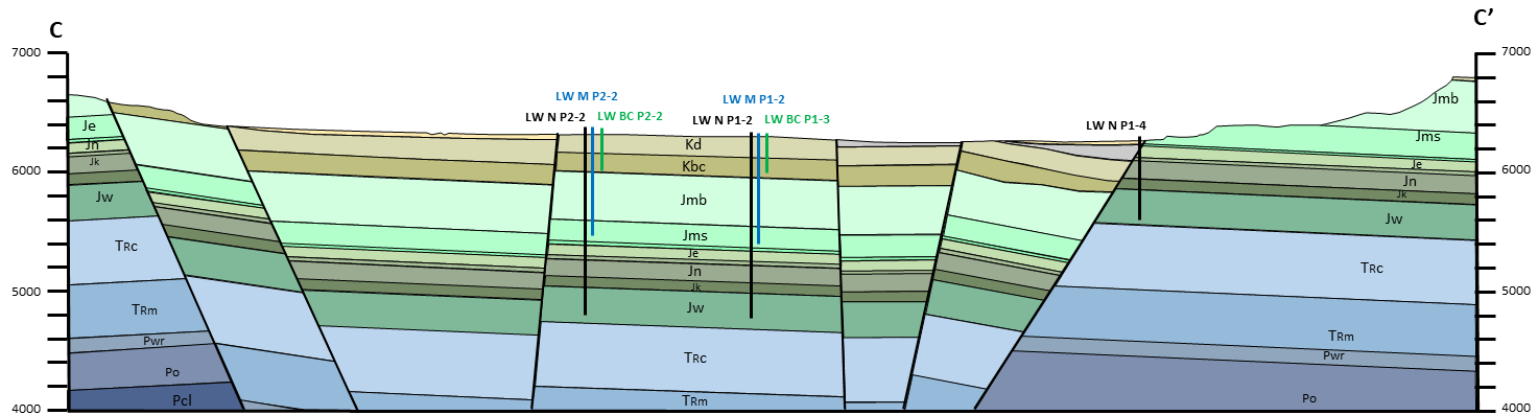

12.2.4 Point of Compliance Monitoring

POC monitoring will be conducted quarterly in accordance with UDWQ permit requirements. This will include water level measurements and groundwater sampling for constituents detailed in Table 12.2. Groundwater sampling will be conducted using low-flow submersible pumps.

Table 12.2 Groundwater Analyte List and Methods

Test Analyte/Parameter	Units	Analytical Method
Physical Properties		
pH /	pH units	A4500-H B
Total Dissolved Solids (TDS) +	mg/L	A2540 C
Conductivity	µmhos/cm	A2510 B
Common Elements and Ions		
Alkalinity (as CaCO ₃)	mg/L	A2320 B
Bicarbonate Alkalinity (as CaCO ₃)	mg/L	A2320 B (as HCO ₃)
Calcium	mg/L	E200.7
Carbonate Alkalinity (as CaCO ₃)	mg/L	A2320 B
Chloride, Cl	mg/L	A4500-Cl B; E300.0
Magnesium, Mg	mg/L	E200.7
Nitrate, NO ₃ ⁻ (as Nitrogen)	mg/L	E300.0
Potassium, K	mg/L	E200.7
Sodium, Na	mg/L	E200.7
Sulfate, SO ₄	mg/L	A4500-SO4 E; E300.0
Trace and Minor Elements		
Arsenic, As	mg/L	E200.8
Barium, Ba	mg/L	E200.8
Boron, B	mg/L	E200.7
Cadmium, Cd	mg/L	E200.8
Chromium, Cr	mg/L	E200.8
Copper, Cu	mg/L	E200.8
Fluoride, F	mg/L	E300.0
Iron, Fe	mg/L	E200.7
Lead, Pb	mg/L	E200.8
Manganese, Mn	mg/L	E200.8
Mercury, Hg	mg/L	E200.8
Molybdenum, Mo	mg/L	E200.8
Nickel, Ni	mg/L	E200.8
Selenium, Se	mg/L	E200.8, A3114 B
Silver, Ag	mg/L	E200.8
Uranium, U	mg/L	E200.7, E200.8
Vanadium, V	mg/L	E200.7, E200.8
Zinc, Zn	mg/L	E200.8
Radiological Parameters		
Gross Alpha††	pCi/L	E900.0
Gross Beta	pCi/L	E900.0
Radium, Ra-226 [§]	pCi/L	E903.0

/ Field and Laboratory

+ Laboratory only

†† Excluding radon, radium, and uranium

§ If initial analysis indicates presence of Th-232, then Ra-226 will be considered within the baseline sampling program or an alternative may be proposed.

12.3 Groundwater Restoration Monitoring

During all phases of groundwater restoration, including active restoration and stability monitoring, POC monitoring will continue in accordance with UDWQ permit conditions. The following additional monitoring associated with groundwater restoration will be conducted in accordance with UDWQ permit requirements.

12.3.1 Establishing Production Zone Baseline Water Quality

Production zone baseline water quality and TRGs will be established according to UDWQ permit requirements. Prior to copper ISR, a subset of wells within each well field to be utilized as production wells will be identified for baseline water quality sampling. Baseline water quality and TRGs will be established according to statistical methods approved by UDWQ.

The Company has identified up to 55 wells in the Project Area for water quality monitoring. This would include 19 BC monitoring wells, 12 Morrison Formation wells, and 24 N Aquifer wells (Table 12.1). The expected sample frequency is one sample per monitoring well per quarter, with samples analyzed for the constituents listed in Table 12.2.

The Company has a comprehensive understanding of aquifer water quality, both at the Lisbon Valley Mine and the Project Area. Current baseline water quality for groundwater monitoring wells is shown in Table 12.3. MCL exceedances are shaded gray. Historic cumulative water quality for LVMC is compiled in Appendix K.

Table 12.3

LLV Baseline Groundwater Quality BC and N Aquifers

		Water Quality Range	
		Lower Lisbon Valley	
		BC Aquifer	N-Aquifer
Major Ions + Indicator Parameters			
Alkalinity, dissolved (as CaCO ₃)	mg/l	105 - 163.2	185.4 - 328.1
Alkalinity (as CaCO ₃)	mg/l	125 - 1,517	179 - 430
Bicarbonate (as CaCO ₃)	mg/l	125 - 1,517.3	179 - 429.8
Carbonate (as CaCO ₃)	mg/l	<1.7 - 31	<1 - 19
Hydroxide (as CaCO ₃)	mg/l	<2 - <14.7	<1 - 5.9
Hardness (as CaCO ₃)	mg/l	109 - 748	64 - 556
Calcium	mg/l	16.2 - 184	16.7 - 141
Magnesium	mg/l	11.4 - 108	5.3 - 46.1
Potassium	mg/l	7.7 - 17	3.72 - 12.6
Sodium	mg/l	71.6 - 1,540	50.1 - 248
Chloride	mg/l	9.3 - 81.9	4.9 - 310
Fluoride	mg/l	0.09 - 1.30	<0.1 - 1
Silica	mg/l	1.5 - 24.8	8.3 - 25.9
Sulfate	mg/l	131 - 2,800	6 - 533
Sodium Absorption Ratio (SAR)	%	1.61 - 1.79	3 - 4.7
Total Dissolved Solids	mg/l	542 - 5,340	260 - 1,440
Total Suspended Solids	mg/l	<5 - 11,700	<5 - 6,280
pH, Lab	s.u.	6.3 - 8.8	6.4 - 8.5
E.C. Lab	µS/cm	861 - 6,680	267 - 1,715
Nutrients			
Phosphorus, total as P	mg/l	<0.01 - 0.26	0.01 - 2.3
Nitrate as N, dissolved	mg/l	<0.02 - 1.59	0 - 0.5
Nitrite as N, dissolved	mg/l	0 - <0.05	0 - 0.094
Nitrate/Nitrite as N, dissolved	mg/l	<0.02 - 1.59	0 - 0.5
Nitrogen, ammonia	mg/l	<0.05 - 8.85	<0.05 - 1.7
Metals			
Aluminum, dissolved	mg/l	0.01 - 0.98	<0.03 - 1.12
Antimony, dissolved	mg/l	0.0004 - 0.012	<0.0002 - <0.02
Arsenic, dissolved	mg/l	<0.0002 - <0.04	<0.0002 - 0.0476
Barium, dissolved	mg/l	0.006 - 0.715	0.031 - 1.29
Beryllium, dissolved	mg/l	<0.00005 - <0.01	<0.00005 - <0.005
Cadmium, dissolved	mg/l	<0.00005 - 0.0597	<0.00005 - <0.003
Chromium, dissolved	mg/l	<0.0001 - 0.014	0.0001 - 0.1055
Copper, dissolved	mg/l	<0.002 - <0.05	<0.01 - 0.04
Iron, dissolved	mg/l	<0.01 - 39.3	0.01 - 15.7
Lead, dissolved	mg/l	<0.0001 - 0.069	<0.0001 - 0.0152
Manganese, dissolved	mg/l	0.008 - 1.18	0.017 - 5.4
Mercury, dissolved	mg/l	<0.0002 - 0.0003	<0.0002 - 0.00079
Molybdenum, dissolved	mg/l	<0.01 - 0.566	0.01 - 0.84
Nickel, dissolved	mg/l	<0.008 - 0.109	<0.008 - 17.3
Selenium, dissolved	mg/l	<0.0001 - 0.027	0.0001 - 0.012
Silver, dissolved	mg/l	<0.00005 - 0.526	<0.00005 - <0.5
Strontium, dissolved	mg/l	2.39 - 4.48	1.62 - 5.75
Thallium, dissolved	mg/l	<0.00005 - 0.014	<0.00005 - 0.009
Uranium, total	mg/l	0.0002 - 0.293	0.0000846 - 0.138
Vanadium, dissolved	mg/l	<0.002 - <0.04	<0.005 - 0.014
Zinc, dissolved	mg/l	0.01 - 1.7	<0.01 - 20.8
Radiological			
Gross Alpha, total	pCi/l	0.3 - 888	-0.73 - 277
Gross Beta, total	pCi/l	9 - 678	2.5 - 310
Radium 226, total	pCi/l	0.91 - 14	0.2 - 5.3
Radium 228, total	pCi/l	0.7 - 6	0 - 13.2
Thorium 228, total	pCi/l	0.32 - 1.27	-0.29 - 2.7
Thorium 230, total	pCi/l	0.4 - 7.5	-0.88 - 4
Thorium 232, total	pCi/l	0.2 - 1.8	-1.2 - 1.75

Table 12.4 Statistics of LLV MCL Exceedance BC and N Aquifers

		Burro Canyon Aquifer						N-Aquifer					
		Summary Statistics						Summary Statistics					
		Range		Mean	Median	# Samples	# Non-Detects	Range		Mean	Median	# Samples	# Non-Detects
Min.	Max.	Min.	Max.										
Major Ions + Indicator Parameters													
Alkalinity, dissolved (as CaCO ₃)	mg/l	105	163	144	162	3	0	185	328	259	254	9	0
Alkalinity (as CaCO ₃)	mg/l	125	1,517.0	282.6	258.0	101	0	179.0	430.0	265.3	254.0	129	0
Bicarbonate (as CaCO ₃)	mg/l	125	1,517.3	279	258	101	0	179	429.8	261	248	129	0
Carbonate (as CaCO ₃)	mg/l	<1.7	31	5	<2	97	77	<1	19	3	<2	129	91
Hydroxide (as CaCO ₃)	mg/l	<2	<14.7	3	<2	97	96	<1	5.9	2	<2	129	123
Hardness (as CaCO ₃)	mg/l	109	748	433	473	101	0	64	556	219	188	129	0
Calcium	mg/l	16.2	184	103	117	101	0	16.7	141	53.3	45.2	129	0
Magnesium	mg/l	11.4	108	42.4	43.9	101	0	5.3	46.1	20.6	18.9	129	0
Potassium	mg/l	7.7	17	9.5	9.21	101	0	3.72	12.6	7.2	6.8	129	0
Sodium	mg/l	71.6	1,540	146	124	101	0	50.1	248	121	119	129	0
Chloride	mg/l	9.3	81.9	23	22	101	0	4.9	310	64	43	129	0
Fluoride	mg/l	0.09	1.30	0.5	0.40	101	5	<0.1	1	0.6	0.6	129	1
Silica	mg/l	1.5	24.8	10.9	11.8	101	1	8.3	25.9	14.4	13.9	129	0
Sulfate	mg/l	131	2,800	463	480	101	0	6	533	150	110	129	0
Sodium Adsorption Ratio (SAR)	%	1.61	1.79	1.70	1.70	2	0	3	4.7	3.66	3.38	6	0
Total Dissolved Solids	mg/l	542	5,340	986	1,010	101	0	260	1,440	605	540	129	0
Total Suspended Solids	mg/l	<5	11,700	832	9.0	101	38	<5	6,280	509	83	129	21
pH, Lab	s.u.	6.3	8.8	7.8	8	101	0	6.4	8.5	7.8	8.2	129	0
E.C. Lab	µS/cm	861	6,680	1,358	1,370	101	0	267	1,715	951	936	129	0
Nutrients													
Phosphorus, total as P	mg/l	<0.01	0.26	0.03	<0.02	43	24	0.01	2.3	0.33	0.10	42	16
Nitrate as N, dissolved	mg/l	<0.02	1.59	0.16	0.04	101	49	0	0.5	0.07	0.02	129	79
Nitrite as N, dissolved	mg/l	0	<0.05	0.01	<0.01	100	79	0	0.094	0.01	<0.01	129	113
Nitrate/Nitrite as N, dissolved	mg/l	<0.02	1.59	0.16	0.05	101	49	0	0.5	0.08	0.03	129	75
Nitrogen, ammonia	mg/l	<0.05	8.85	0.24	0.050	100	68	<0.05	1.7	0.15	0.08	129	62
Metals													
Aluminum, dissolved	mg/l	0.01	0.98	0.06	<0.03	101	80	<0.03	1.12	0.05	<0.03	129	91
Antimony, dissolved	mg/l	0.0004	0.012	0.0014	<0.0004	100	82	<0.0002	<0.02	0.0024	0.0005	129	94
Arsenic, dissolved	mg/l	<0.0002	<0.04	0.0035	0.002	101	33	<0.0002	0.0476	0.0091	0.0064	129	25
Barium, dissolved	mg/l	0.006	0.715	0.034	0.013	101	0	0.031	1.29	0.151	0.088	129	0
Beryllium, dissolved	mg/l	<0.00005	<0.01	0.0004	<0.0001	101	98	<0.00005	<0.005	0.0004	<0.0001	129	121
Cadmium, dissolved	mg/l	<0.00005	0.0597	0.0076	0.0034	101	29	<0.00005	<0.003	0.0005	<0.0001	129	112
Chromium, dissolved	mg/l	<0.0001	0.014	0.0015	<0.0005	101	88	0.0001	0.1055	0.0046	<0.0005	129	85
Copper, dissolved	mg/l	<0.002	<0.05	0.01	<0.01	101	93	<0.01	0.04	0.01	<0.01	129	117
Iron, dissolved	mg/l	<0.01	39.3	1.37	0.35	101	7	0.01	15.7	0.85	0.31	129	14
Lead, dissolved	mg/l	<0.0001	0.069	0.0019	0.0002	100	58	<0.0001	0.0152	0.0018	0.0005	129	96
Manganese, dissolved	mg/l	0.008	1.18	0.153	0.12	101	1	0.017	5.4	0.349	0.12	129	6
Mercury, dissolved	mg/l	<0.0002	0.0003	0.0002	<0.0002	101	98	<0.0002	0.00079	0.0002	<0.0002	129	119
Molybdenum, dissolved	mg/l	<0.01	0.566	0.04	0.02	101	36	0.01	0.84	0.08	<0.02	129	58
Nickel, dissolved	mg/l	<0.008	0.109	0.01	<0.01	101	71	<0.008	17.3	0.44	<0.01	129	73
Selenium, dissolved	mg/l	<0.0001	0.027	0.002	<0.001	100	60	0.0001	0.012	0.002	<0.001	129	107
Silver, dissolved	mg/l	<0.00005	0.526	0.01772	<0.00005	101	94	<0.00005	<0.5	0.01191	<0.00005	129	117
Strontium, dissolved	mg/l	2.39	4.48	3.13	2.53	3	0	1.62	4.81	2.93	2.645	4	0
Thallium, dissolved	mg/l	<0.00005	0.014	0.0005	0.0002	100	55	<0.00005	0.009	0.0006	<0.0001	129	118
Uranium, total	mg/l	0.0002	0.293	0.0395	0.0288	94	0	0.000085	0.138	0.0113	0.0041	129	23
Vanadium, dissolved	mg/l	<0.002	<0.04	0.007	<0.005	101	98	<0.005	0.014	0.007	<0.005	129	119
Zinc, dissolved	mg/l	0.01	1.7	0.15	0.03	101	22	<0.01	20.8	0.50	0.02	129	52
Radiological													
Gross Alpha, total	pCi/l	0.3	888	73	22	104	0	-0.73	277	24	13	130	0
Gross Beta, total	pCi/l	9	678	63	20	104	0	2.5	310	34	15	130	0
Radium 226, total	pCi/l	0.91	14	7	6.05	20	0	0.2	5.3	1	1.0	64	0
Radium 228, total	pCi/l	0.7	6	3	2.4	19	0	0	13.2	2	1.5	55	0
Thorium 228, total	pCi/l	0.32	1.27	1	0.97	5	0	-0.29	2.7	0	0.03	18	0
Thorium 230, total	pCi/l	0.4	7.5	3	3.1	20	0	-0.88	4	1	0.675	56	0
Thorium 232, total	pCi/l	0.2	1.8	1	0.80	20	0	-1.2	1.75	0	0.30	52	0

12.4 Monitoring during Active Restoration

The Company will monitor the progress of aquifer restoration by sampling ore zone monitor wells in each well field at a frequency sufficient to determine the success of aquifer restoration, optimize the efficiency of aquifer restoration, and determine if any areas need additional attention.

12.5 Reporting

Prior to operation of each well field, the Company will prepare and submit an injection authorization data package. The data package will provide the planned locations of injection, production and monitor wells and the results of formation testing. The data packages will request authorization to initiate injection into each well field. The Company will complete MIT and a well completion report for each injection well prior to initiating injection into that well.

Quarterly monitoring reports will be submitted to UDWQ. At minimum, the quarterly monitoring reports will include the following information:

- Physical, chemical and other relevant characteristics of injection fluids
- Monthly average, maximum and minimum values for injection pressure, flow rate and volume
- Quarterly MIT results, a list of any wells failing MIT and corrective actions taken, and a list of wells anticipated to undergo MIT during the next quarter
- Any well maintenance activities

Signed quarterly reports will be submitted electronically unless otherwise directed by the UDWQ. If required, a signature letter from the Company Representative will accompany the electronic submission to certify the report. Reports will consist of monthly summary information for the project. Monitoring reports will include raw data and graphical analysis for the current reporting period to date. Each calendar quarter, the maximum, minimum, and average monthly values for each continuously monitored parameter specified for the injection wells will be tabulated. A narrative description of any deviations from permit limitations will be given. Maintenance activities, MIT activities, and other significant events that took place during the reporting period will be described. If an excursion has potential to impact a USDW, it will be reported verbally to UDEQ within 24 hours and followed up within 5 days in written form.

12.6 Record Keeping

Well completion records and all monitoring information, including calibration and maintenance records and data from the continuous monitoring instrumentation will be retained for at least three (3) years after all wells have been plugged and abandoned. This includes:

- Injection well completion reports.
- Information on the nature, volume, and composition of all injected fluids.
- MIT results, description and results of any other tests required by UDEQ, and any well work-overs completed.

The records discussed above (originals or copies) will be retained on site unless written approval to discard the records is provided by the UDWQ. Copies of these records (or originals) will be maintained for all observation records throughout the operating life of each well. The Company also will maintain an

electronic database containing well completion and MIT records for all injection wells. The database will be provided for UDWQ use upon request.

12.7 Quality Assurance

After permit issuance but prior to operations, the Company will prepare and submit to UDWQ a Quality Assurance Project Plan (QAPP). The purpose of the QAPP is to ensure that all groundwater quality measurements are reasonably valid and of a defined quality. These programs are needed (1) to identify deficiencies in the sampling and measurement processes and report them to those responsible for these operations so that permittees may take corrective action and (2) to obtain some measure of confidence in the results of the monitoring programs to assure the regulatory agencies and the public that the results are valid.

Attachment G

Contingency Plan for Well Shut-ins or Well Failures

13.0 PART K - Contingency Plan

This attachment outlines contingency plans to cope with system shut-ins or failures to prevent migration of fluids into any USDWs.

13.1 Introduction

The endangerment of USDWs may occur via any combination of at least three contamination pathways in which fluids can escape the injection zone and enter USDWs. These pathways include:

- 1) Migration of fluids vertically through a faulty N Aquifer monitoring well
- 2) Migration of fluids laterally into the N Aquifer
- 3) Migration of fluids vertically into the N Aquifer

The extent to which a USDW is threatened will depend on a number of factors including:

- The nature of the fluid being injected;
- The volume of the fluid being injected;
- The hydraulics of the flow system (pressure in the injection zone and overlying USDWs); and
- The amount of fluid that may enter the USDW via one or more of the pathways.

Proper construction and MIT of injection wells as outlined in Section 11 and effective monitoring as described in Section 14 will reduce the likelihood that any USDWs will be threatened.

13.2 Prevention Measures

13.2.1 Integrity Testing of Casing

Each new injection, production and monitor well will be logged using a cement bond log to determine the quality of [cement](#) bond on the exterior casing wall. This will be followed with pressure tested to confirm the integrity of the casing prior to being used for ISR operations. Mechanical integrity will be demonstrated after a well is constructed and before it is put into use. MIT procedures are discussed in Section 11.5. Wells that fail MIT criteria will be repaired or plugged and abandoned and replaced as necessary.

13.2.2 General Shutdown

All production, injection and monitor wells will be constructed of well casing that is cemented on the exterior to prevent vertical migration of ISR solutions up the annulus between the drill hole and the casing. Both production and injection wells will be piped into a collection header piping and collection ponds.

Each production well will have a submersible pump associated with a circuit breaker that will be labeled with the corresponding well number (e.g., GTO-50 or LW-100). Each circuit breaker will have a start and stop switch that can be used to energize or de-energize the pump motor. The circuit breaker will be the main source of electrical power and will be used to de-energize and lock out the pump motor as necessary for repairs or maintenance.

Each injection well will have a block valve between the header and the flow meter so that the injection well may be blocked off to service the meter and the well. There will be a manual flow control valve and a

flow meter on each production and injection well to regulate the flow to and from each well and to balance the individual well patterns. The flow meters will be labeled with designated well identification numbers. The block valves will be closed for the appropriate injection or production well for shutdown and tag out.

13.2.3 Emergency Shutdown

The Company will install automated control and data recording systems at the GTO, Lone Wolf, and Flying Diamond facilities which will provide centralized monitoring and control of the process variables including the flows and pressures of production and injection streams. The systems will include alarms and automatic shutoffs to detect and control a potential release or spill.

Pressure and flow sensors will be installed, for the purpose of leak detection, on the main trunk lines that connect the process facilities to the well fields. In addition, the flow rate of each production and injection well will be measured automatically. Measurements will be collected and transmitted to both the process facilities control systems. Should pressures or flows fluctuate outside of normal operating ranges, alarms will provide immediate warning to operators which will result in a timely response and appropriate corrective action.

Both external and internal shutdown controls will be installed at well head to provide for operator safety and spill control. The external and internal shutdown controls will be designed for automatic and remote shutdown of each well head. In the event of a well shutdown, an alarm will occur and the flows of all injection and production to that well will be automatically stopped.

13.2.4 Point of Compliance Exceedance Control

During production operations, lixiviant will be injected into the production zone through the injection wells, and recovery solution will be withdrawn by the submersible pumps in the production wells. During aquifer restoration, permeate and/or clean makeup water from the N Aquifer will be injected into injection wells and recovery solution pumped from the production wells. Recovering more groundwater than is injected during production and restoration will maintain a localized cone of depression for each well field. This induced gradient from the surrounding area toward the well field will serve as a control over the movement of ISR solutions and minimize the potential for lateral excursions.

Pre-operational POC exceedance preventative measures will include, but will not be limited to:

- 1) Proper well construction cement bond log, and MIT of each well before use;
- 2) Monitor well design schema based upon delineation drilling to further characterize the zones of mineralization and to identify the target completion zones for all monitor wells; and
- 3) Pre-operational pumping tests with monitoring systems in place to obtain a detailed understanding of the local hydrogeology and to demonstrate the adequacy of the monitoring system.

Operational POC exceedance preventative measures will include but will not be limited to:

- 1) Regular monitoring of flow and pressure on each production and injection well;
- 2) Regular flow balancing and adjustment of all production and injection flows

appropriate for each production pattern;

- 3) Monitoring of hydrostatic water levels in monitor wells to verify the inward hydraulic gradient; and
- 4) Regular collection of samples from all monitor wells to determine the presence of any indicators of the migration of ISR solutions horizontally or vertically from the production zone.

Monitor wells will be positioned to detect any ISR solutions that may potentially migrate away from the production zone due to an imbalance in well field pressure. Prior to injecting lixiviant into each well field, pre-operational pump testing will be conducted to demonstrate hydraulic connection between the production and injection wells and all perimeter monitor wells. Sampling of monitor wells will occur according to the schedule described in Section 12.2.

Controls for preventing migration of ISR solutions to overlying and underlying aquifers consist of:

- Regular monitoring of hydrostatic water levels and sampling for analysis of indicator species;
- Routine MIT of all wells on a regular basis (at least every 5 years) to reduce any possibility of casing leakage;
- Completion of MIT on all wells before putting them into service or after work which involves drilling equipment inside of the casing;
- Proper plugging and abandonment of all wells which do not pass MIT or that become unnecessary for use;
- Proper plugging and abandonment of exploration holes with potential to impact ISR operations; and
- Sampling monitor wells located within the overlying and underlying hydrogeologic units on a quarterly schedule.

13.3 Point of Compliance Exceedance Corrective Action

The Company will implement the following corrective action plan for POC exceedances occurring during production or restoration operations. Corrective actions to correct and retrieve an POC exceedance will include but will not be limited to:

- Adjusting the flow rates of the production and injection wells to increase the aquifer bleed in the area of the excursion;
- Terminating injection into the portion of the well field affected by the excursion;
- Installing pumps in injection wells in the portion of the well field affected by the excursion to retrieve ISR solutions;
- Replacing injection or production wells; and
- Installing new pumping wells adjacent to the well on excursion status to recover ISR solutions.

13.4 Mitigation Measures for Other Potential Environmental Impacts

13.4.1 Spills and Leaks

Well field features such as header houses, well heads or pipelines could contribute to pollution in the unlikely event of a release of ISR solution due to pipeline or well failure. Potential impacts will be minimized by routine MIT of all injection, production and monitor wells and hydrostatic leak testing of all pipelines during construction; implementing an instrumentation and control system to monitor pressure and flow and immediately detect and correct an anomalous condition; and implementing a spill response and cleanup program in accordance with UDEQ and UDOGM permit conditions.

13.4.2 Potential Natural Disaster Risk

See Seismology Section 3.7.

13.4.3 Potential Fire and Explosion Risk

The design criteria for chemical storage and feeding systems include applicable sections of the MSHA regulations and RCRA regulations and the Company will expand any current training and protocols to include the ISR project. The Company will maintain firefighting equipment on site.

13.4.4 Potential Power Outage

Power outages in the Project area would not be likely to last more than a few days or weeks under most conceivable scenarios. The Company will use generators onsite and may also contract for temporary generators to operate well field pumps sufficiently to maintain an inward hydraulic gradient within each well field if unforeseen power outages occur with expected duration of more than two weeks. Backup generators will be installed to maintain continuous instrumentation monitoring and alarms in the process facilities and well fields. Backup power also will be provided for lights.

14.0 PART L - Wellfield Closure Plan

This attachment describes the wellfield closure plan for the Class III injection and extraction wells. This includes i) wellfield rinsing ii) plugging and abandonment, and iii) post-closure closure monitoring.

The Company has evaluated closure costs associated with one and three years of ISR operations (Table 14.1) . The Company does not believe modeling closure scenarios beyond year three years of ISR operations is practical given the Company will be reviewing projections vs. actual operations as part of ongoing review of closure costs. The Company plans to conduct concurrent closure of portions of the wellfields that have completed copper leaching as new areas of the wellfield come into production.. The Company projects installing a total of 71 ISR well including a small test well array over the first three years of ISR operations that the Company will bond, see figure 11.8 for preliminary well installation schedule. The Company plans to review the adequacy of its bond with UDWQ within three years of commencing ISR operations to adjust the amount as necessary based on project advancement and review of actual ISR operating data.

Attachment H

Groundwater Restoration Plan

13.4 Mitigation Measures for Other Potential Environmental Impacts

13.4.1 Spills and Leaks

Well field features such as header houses, well heads or pipelines could contribute to pollution in the unlikely event of a release of ISR solution due to pipeline or well failure. Potential impacts will be minimized by routine MIT of all injection, production and monitor wells and hydrostatic leak testing of all pipelines during construction; implementing an instrumentation and control system to monitor pressure and flow and immediately detect and correct an anomalous condition; and implementing a spill response and cleanup program in accordance with UDEQ and UDOGM permit conditions.

13.4.2 Potential Natural Disaster Risk

See Seismology Section 3.7.

13.4.3 Potential Fire and Explosion Risk

The design criteria for chemical storage and feeding systems include applicable sections of the MSHA regulations and RCRA regulations and the Company will expand any current training and protocols to include the ISR project. The Company will maintain firefighting equipment on site.

13.4.4 Potential Power Outage

Power outages in the Project area would not be likely to last more than a few days or weeks under most conceivable scenarios. The Company will use generators onsite and may also contract for temporary generators to operate well field pumps sufficiently to maintain an inward hydraulic gradient within each well field if unforeseen power outages occur with expected duration of more than two weeks. Backup generators will be installed to maintain continuous instrumentation monitoring and alarms in the process facilities and well fields. Backup power also will be provided for lights.

14.0 PART L - Wellfield Closure Plan

This attachment describes the wellfield closure plan for the Class III injection and extraction wells. This includes i) wellfield rinsing ii) plugging and abandonment, and iii) post-closure closure monitoring.

The Company has evaluated closure costs associated with one and three years of ISR operations (Table 14.1) . The Company does not believe modeling closure scenarios beyond year three years of ISR operations is practical given the Company will be reviewing projections vs. actual operations as part of ongoing review of closure costs. The Company plans to conduct concurrent closure of portions of the wellfields that have completed copper leaching as new areas of the wellfield come into production.. The Company projects installing a total of 71 ISR well including a small test well array over the first three years of ISR operations that the Company will bond, see figure 11.8 for preliminary well installation schedule. The Company plans to review the adequacy of its bond with UDWQ within three years of commencing ISR operations to adjust the amount as necessary based on project advancement and review of actual ISR operating data.

14.1 Wellfield Rinsing

If the proposed ISR wellfield needs to be closed at any time during the first three years of operation,, the Company will initiate an approximate two year closure plan. The closure plan will involve cessation of acid addition, rinsing with fresh water, aquifer rest/neutralization, and wellfield recirculation. The total projected rinsing and recirculation will comprise approximately five pore volumes. Rinse water will be pumped and extracted from the wellfield(s) and evaporated at the ISR collection ponds using forced and natural evaporation (750 gpm capacity).

The Company's closure plan is based on geochemical modeling and metallurgical test results that indicate neutralization and constituent concentration reduction to appropriate levels can be accomplished in approximately two years. The rate and capacity of pH neutralization is well-understood and projected as a function of 15 years of leach pad operation and monitoring which requires daily pH control and observation of the same ore host rock targeted by ISR operations.

The closure plan involves three primary steps. First, following cessation of acid addition, the acidified leaching solution is rested in place to take advantage of the well-documented neutralization capacity of the gangue remaining in the ore body. Sufficient extraction of the leach solution will be maintained to ensure an inward hydraulic gradient while also injecting fresh water using the Company's 300+ gpm wellfield capacity. The initial rest will extend approximately 7 months. Leaching solution extracted during the initial step will be piped to a forced evaporation system and evaporated. Following this, the wellfield will be recirculated for a period of 9 months. Recirculation during phase 2 will allow solution which has not been neutralized to sweep through the acid consuming host rock while continuing to dilute with fresh water. The pH changes during all phases will be measured using pH probes dedicated to selected wells. After five pore volumes of recirculation, the Company projects a third step of replacing one pore volume with fresh water. Rinse water is projected to be supplied by the Company's existing water well supply which will predominantly withdraw groundwater from the BC aquifer. Hydraulic control wells, located along the perimeter of the wellfields are projected to provide additional fresh water for rinsing as the wellfields expand. These wells may be augmented by a water treatment facility as needed to increase rinsing capacity. The final step is anticipated to extend over the balance of the second year of restoration, or sufficient time to normalize pH in the BC aquifer. As pH returns to the projected neutral level, the Company projects being able to meet a water quality standard protective of human health and USDWs.

The Company has projected its wellfield rinsing and evaporation costs based on actual operating data and information used for bonding open pit operations with DOGM. In addition, the Company currently operates infrastructure needed to support ISR. This includes overhead power, monitoring wells, piping, and process ponds.

14.1.1 Mobilization

In the event that the Company defaults on its obligations under the permit, it is assumed the State of Utah would likely hire a remediation contractor to conduct the necessary closure and post closure operations, using subcontractors where necessary to perform such services as rinsing, well abandonment and pump replacement. It is also assumed the contractor would need to assemble a team and mobilize to the site in order to begin rinsing and closure operations. A lump sum estimate of \$[75,000] is assumed for preparation and planning and \$[20,000] to mobilize and demobilize from site.

14.1.2 Labor

Labor costs for bonding assume manager-level, staff-level, and admin-level rates using RS Means. These costs are included in Table 14.1.

14.1.3 Power Consumption

The Company has estimated the number of gallons required to achieve five pore volumes of recirculation rinsing plus the cost of pumping water from fresh-water wells. This estimation multiplies the average pump horsepower by time using the Company's prevailing power cost of \$0.06 per KWh. The Company has significant experience operating its existing water wells for over ten years which it has used as a basis for estimating rinsing power costs.

14.1.4 Well Rehabilitation and Maintenance

The Company has projected pump maintenance, spares, and replacement based on actual operating data from its existing portfolio of wells for the past ten years. Well rehabilitation is anticipated to include reverse flushing wells, swabbing, surging, and replacement as necessary to maintain hydraulic control and commercial sweep efficiency.

14.1.5 Rinse Verification Sampling

Rinsing verification consists of groundwater monitoring of injection/recovery wells after rinsing is completed. The cost is calculated based on the number of injection and recovery wells completed by year of operation. Rinse verification sampling will be conducted on 10% of extraction wells. Assuming three years of ISR operation the Company projects having approximately 71 extraction wells in operation. Sampling 10% of these wells equates to one well for every 2.8 acres. A sample size of 10% is considered statistically significant for quality assurance (QA) verification.

14.1.6 Quarterly Reporting

Closure employees will conduct quarterly sampling, rinse verification sampling, and provide quarterly reporting to UDWQ during the well field closure and well abandonment process. This process is estimated to take two years so eight quarterly reports are projected for submission.

14.1 Well Plugging and Abandonment Plan

The plugging and abandonment methods are designed to prevent movement of fluids through the well, out of the production zone, and into USDWs or the land surface. The same procedures will be followed for production and monitor wells. The rinsing method is designed to neutralize ISR leach solutions and restore water quality to a standard mutually agreed upon with UDWQ. The attachment also summarizes the surface reclamation, decontamination and decommissioning activities that will be carried out in accordance with UDWQ permit and UDOGM permit requirements, as well as requirements stipulated by the BLM for public lands within the Project Area.

The Company will plug all wells in accordance with UAC R317-7-10.5 (40 CFR 146.10). Plugging and abandoning will be performed with bentonite or cement grout and will be placed so as to not allow the movement of fluid either into or between underground sources of drinking water. The weight and composition of the grout will be sufficient to control artesian conditions and meet the well abandonment standards of the State of Utah. Cementing will be completed from total depth to surface using a drill pipe.

Attachment I

Plugging and Abandonment Plan

14.1.2 Labor

Labor costs for bonding assume manager-level, staff-level, and admin-level rates using RS Means. These costs are included in Table 14.1.

14.1.3 Power Consumption

The Company has estimated the number of gallons required to achieve five pore volumes of recirculation rinsing plus the cost of pumping water from fresh-water wells. This estimation multiplies the average pump horsepower by time using the Company's prevailing power cost of \$0.06 per KWh. The Company has significant experience operating its existing water wells for over ten years which it has used as a basis for estimating rinsing power costs.

14.1.4 Well Rehabilitation and Maintenance

The Company has projected pump maintenance, spares, and replacement based on actual operating data from its existing portfolio of wells for the past ten years. Well rehabilitation is anticipated to include reverse flushing wells, swabbing, surging, and replacement as necessary to maintain hydraulic control and commercial sweep efficiency.

14.1.5 Rinse Verification Sampling

Rinsing verification consists of groundwater monitoring of injection/recovery wells after rinsing is completed. The cost is calculated based on the number of injection and recovery wells completed by year of operation. Rinse verification sampling will be conducted on 10% of extraction wells. Assuming three years of ISR operation the Company projects having approximately 71 extraction wells in operation. Sampling 10% of these wells equates to one well for every 2.8 acres. A sample size of 10% is considered statistically significant for quality assurance (QA) verification.

14.1.6 Quarterly Reporting

Closure employees will conduct quarterly sampling, rinse verification sampling, and provide quarterly reporting to UDWQ during the well field closure and well abandonment process. This process is estimated to take two years so eight quarterly reports are projected for submission.

14.1 Well Plugging and Abandonment Plan

The plugging and abandonment methods are designed to prevent movement of fluids through the well, out of the production zone, and into USDWs or the land surface. The same procedures will be followed for production and monitor wells. The rinsing method is designed to neutralize ISR leach solutions and restore water quality to a standard mutually agreed upon with UDWQ. The attachment also summarizes the surface reclamation, decontamination and decommissioning activities that will be carried out in accordance with UDWQ permit and UDOGM permit requirements, as well as requirements stipulated by the BLM for public lands within the Project Area.

The Company will plug all wells in accordance with UAC R317-7-10.5 (40 CFR 146.10). Plugging and abandoning will be performed with bentonite or cement grout and will be placed so as to not allow the movement of fluid either into or between underground sources of drinking water. The weight and composition of the grout will be sufficient to control artesian conditions and meet the well abandonment standards of the State of Utah. Cementing will be completed from total depth to surface using a drill pipe.

Cementing wells with damage to casing and/or formation may require additional cement. This will be recorded along with the following information:

- well ID, total depth, and location
- driller, company, or person doing the cementing work
- total volume of grout placed down hole
- viscosity and density of the grout

The Company will remove surface casing or cut off surface casing below ground and set a cement surface plug on each well plugged and abandoned.

The Company estimates well plugging and abandonment costs of approximately \$5.00 per foot based on current pricing from a local drilling contractor plus a \$200 per well capping charge. For the first three years of ISR operations, the Company projects drilling a total of approximately production 71 wells and 13 monitoring wells, all of which would require abandonment. The Company projects plugging and abandonment cost of these wells to be approximately \$708,000.

14.2 Plugging and Abandonment Reporting

According to 40 CFR § 144.51(p) the operator is to notify the EPA within 60 days after plugging or at the time of the next quarterly report (whichever is less). In accordance with this requirement, a Plugging and Abandonment Report will be submitted to the EPA. The person that performs the plugging operation will certify the report as accurate. The report will contain either:

- A statement that the well was plugged in accordance with the approved Plugging and Abandonment Plan; or
- If the actual plugging differed from the Plugging and Abandonment Plan, a statement specifying the different procedures followed.

Documentation will be provided to verify that the quantity of sealing material placed in the well is at least equal to the volume of the empty hole.

The Plugging and Abandonment Reports will be retained for at least 3 years from the date of the submission unless the EPA requests an extension. If requested, at the conclusion of the retention period, the reports will be delivered to the EPA.

14.3.7 Post Closure Monitoring

Post closure monitoring will comprise of five years of annual monitoring at 16 monitor well locations; 9 at Lone Wolf and 7 at GTO. The wellfield will be considered closed once five consecutive annual rounds of monitoring meet TRGs for the N Aquifer. The Company conservatively projects post closure monitoring for ten years even though it projects only requiring five years to reach well field closure status.

14.4 Facility Decommissioning

Following regulatory approval of successful aquifer restoration in all well fields, the Company will decommission all well fields, processing facilities, ponds, and equipment within the Project Area. Decommissioning activities will be done in accordance with UDWQ permit and UDOGM large scale mine permit requirements. Surface reclamation and revegetation will be conducted in accordance with

UDOGM large scale mine permit requirements and requirements stipulated by the BLM. The decommissioning program will ensure that the Project Area is closed in a manner that permits release for unrestricted use.

14.5 Necessary Resources

The Company projects closing approximately the same number of wells that it drills annually beginning approximately five years after ISR operations commence (the Company estimates approximately five years to complete copper recovery of a respective ore block). This concurrent closure planning adheres to current Company operating practices employed for open pit mining operations and limits the closure costs from becoming excessively large at the end of the project.

Following review and approval of the closure plan, a financial assurance instrument will be submitted to UDWQ to assure the required activities will be completed to safeguard potential USDWs.

Each year the Company will submit a financial assurance update indicating the anticipated number of injection wells to be installed during the next year and wells to close as well as providing an updated financial assurance instrument to include closure costs for the net additional wells. During decommissioning, the financial assurance instrument will be updated annually to reflect the wells closed during the previous year.

During the ongoing ISR operations, the Company will evaluate sweep efficiency, well efficiencies, changes in groundwater quality, neutralization rates, and rinse/recirculation efficiencies. This data, and other pertinent information will be used to prepare a comprehensive Groundwater Restoration Plan and augment planning herein with actual operating data.

Attachment J

Financial Responsibility

The Standby Trust Agreement along with Schedule A and the Associated Financial Guarantee Bond will be approved and delivered to the DEQ's Office of Support Services prior to Director Authorization to Inject.

These documents shall be updated every five years from the effective date of this permit renewal:

Memorandum

To: Lisbon Valley Mining Company
Utah Department of Environmental Quality, Division of Water Quality

Date: August 20, 2021

From: Alison H. Jones
Doug Bartlett

Subject: Independent Financial Assurance Bonding Estimate

1. Introduction

Lisbon Valley Mining Company LLC (LVMC) is the applicant for an underground injection control (UIC) permit for an in situ mining project in La Sal, Utah. A draft permit (UTU-37-AP-5D5F693) has been issued by the Utah Department of Environmental Quality, Division of Water Quality (UDWQ), which included an estimate for three years of financial assurance (FA) bonding for closure of the project. UDWQ requested an independent third-party estimate of the FA amount for the first three years of operation. LVMC retained Clear Creek Associates, LLC (Clear Creek) to conduct the review and formulate an independent estimate for the FA.

The objective of this review is to arrive at an independent FA bonding estimate that is sufficient to meet the conditions required by Part III, Section L.1 of the draft permit. The estimate is based on Clear Creek's understanding of this project and our experience with in situ copper recovery. In situ mining for copper is not a widespread practice at this time. Industry-wide experience related to in situ mining for copper is limited, and to our knowledge, there have been no closures of in situ copper mines in the United States.

1.1 Background

LVMC owns and operates an open-pit copper mine and heap leach operation in lower Lisbon Valley approximately 17 miles southeast of the unincorporated town of La Sal, Utah. LVMC has identified a copper resource immediately south and east of their current operation that they have found to be suitable for in situ mining. Three deposits have been identified: the GTO, Lone Wolf,

and Flying Diamond deposits, which are estimated to contain greater than 800 million pounds of copper suitable for in situ (ISR) recovery. This closure estimate was prepared for 3 years of mining at the GTO deposit. GTO is deeper and more expensive to mine than Lone Wolf and Flying Diamond. Closure costs for the initial three years of mining Lone Wolf and Flying Diamond deposits will be lower than costs for GTO closure.

Disseminated copper is primarily hosted in the Burro Canyon (BC) aquifer and to a lesser extent the deeper Navajo (N) aquifer. The UIC application allows for in situ mining in the BC aquifer only. The BC aquifer water quality is poor, and according to the LVMC application, there are no registered residential, municipal, or other commercial water wells in the BC aquifer within the Project area other than those owned by LVMC.

1.2 Scope of Work

The following tasks were conducted for this review:

- Review of UIC application and draft permit to understand the scope of the project and the steps involved in the closure.
- Discussions with LVMC regarding assumptions made in the initial bond amount.
- Discussion with Peter Brinton at Utah Division of Oil, Gas and Mining (UDOGM) regarding indirect costs and escalation.
- Review/revise and update as necessary for completeness, unit costs, and quantities.
- Preparation of this document summarizing the review with conclusions.

2. Project Description

2.1 Wellfield Operations

ISR is a method of mining where a metal, in this case copper, is dissolved from rock while it is still in the ground (i.e. in situ). There are no open pits, waste rock, or tailings produced in this type of mining. Low pH water, called "raffinate", is injected into wells that are screened in the mineralized zone. As the raffinate travels through the mineralized rock from the injection well to the recovery well, it dissolves the disseminated copper. The raffinate containing dissolved copper flows toward pumping (or recovery) wells, where it is pumped to the surface.

The recovered raffinate (which is now called pregnant leachate solution or “PLS”) is processed in a solution extraction and electrowinning plant. In this process, the metal precipitates out as copper cathode plates. After the copper is removed, the low pH raffinate is then re-circulated into the wellfield.

Injection and recovery wells are generally installed in a grid of “5-spots” where each injection well is surrounded by 4 recovery wells and each recovery well is surrounded by 4 injection wells. The grid may be modified to take advantage of fractures or other features that are identified by geologists as the wellfield expands. Injection wells can be converted to recovery wells (and vice versa), if needed. The injection and recovery wells will be screened in the BC aquifer. Due to low conductivity strata above and below the BC aquifer, solutions will be confined to this aquifer.

At the end of Year 3, the GTO wellfield will contain 71 wells (26 5-spots made up of 26 injection wells, 45 extraction wells) in an approximate 150 foot by 150 foot grid). In addition there will be 7 monitoring wells outside of the wellfield.

2.2 Hydraulic Control

An important element of operating a wellfield is hydraulic control. This is the mechanism by which raffinate/PLS in the aquifer is prevented from escaping the wellfield. Maintaining hydraulic control is important from an economic perspective (PLS is a valuable commodity) and an environmental perspective. A slight inward gradient is maintained so that groundwater flows toward the wellfield from all directions. This inward gradient is achieved by pumping out slightly more water than is pumped into the wellfield, resulting in a cone of depression centered on the wellfield. Maintaining inward gradients is a key principle used for all ISR projects. For this reason, it is important to maintain the proper balance of injection and extraction flow rates.

2.3 Wellfield Closure

After copper grades in the PLS decline, the mine block will undergo closure to neutralize the low pH water in the wellfield and abandon the wells. LVMC has proposed a multi-year closure process that will consist of:

- Rinsing
- Closure Monitoring

- Well Plugging and Abandonment
- Post-Closure monitoring

Each of these steps is summarized in the following sections.

2.3.1 Rinsing

A two-year rinsing process will include the following steps:

- **Step 1**--Wellfield resting: Injection will cease and solution will rest in place for 7 months. During this rest period, solutions will neutralize and hydraulic control will be maintained by pumping a subset of the extraction wells that are spatially distanced throughout the wellfield. Solutions will be pumped to the ISR dedicated collection ponds for evaporation.
- **Step 2**--Wellfield recirculation: over the course of 9 months, approximately five pore volumes of solution will be circulated through the wellfield. Solution removed from the wellfield will be pumped to collection ponds for evaporation as described above. During this time, a lesser amount (approximately 300 gpm) of fresh makeup water will be injected into the wellfield. This strategy will continue to maintain hydraulic control.
- **Step 3**--One pore volume will be pumped from the wellfield and evaporated. As it is removed it will be replaced with a pore volume of fresh water from LVMC's nearby wells.

2.3.2 Closure monitoring

During the two-year rinsing process, eight rounds of quarterly groundwater monitoring, will be conducted to evaluate the rinsing process. Six monitoring wells and four extraction wells will be monitored eight times during the rinse, as described in the permit application. Monitoring results will be reported to the regulators as required in the draft permit.

2.3.3 Well Abandonment

After rinsing and closure monitoring, pumping will be discontinued and the wellfield injection/recovery wells will be plugged and abandoned. The monitoring wells will be filled with a cement to a few feet below the land surface. The annulus above the screened interval will be cemented during initial installation to prevent vertical movement of groundwater and leaching solutions outside the casing.

At the land surface, approximately 2-5 feet of the casing will be removed and the surface will be regraded.

Monitoring wells will remain in service for the 5-year post-closure monitoring period. They will be plugged and abandoned using the same methodology as the injection/extraction wells.

2.3.4 Post-Closure Monitoring

Annual post-closure monitoring will be conducted as described in the permit application. Monitoring results will be reported to the regulators as required in the draft permit.

3. Closure Costs

3.1 Assumptions

This bond review was conducted for the wellfield only. Closure costs for the ISR surface disturbance, which includes surface collection ponds and associated infrastructure will be included in the Company's existing open pit reclamation surety which is active and overseen by UDOGM. Also, all LVMC copper production facilities associated with ISR are covered in the existing reclamation surety with UDOGM. All evaporation activities associated with ISR will be conducted using collection ponds dedicated to the ISR project only and will not have any association with the open pit operation. After completion of ISR evaporation activities, the ISR collection ponds and related surface facilities will be reclaimed per standard UDOGM bonding requirements. Clear Creek reviewed the LVMC UIC permit application, including the closure cost estimate. Assumptions included in this bond estimate are:

- The bond estimate is for closure for the first 3 years of the ISR operations. Year 1 (2022) is primarily construction costs. No in situ leaching will occur in Year 1. Leaching will occur during years 2 (2023) and year 3 (2024). The bond calculation was conducted for the year of greatest reclamation cost liability, which is at the end of Year 3 when the maximum number of injection and recovery wells will exist. All of the activities for Years 1-3 are at the GTO deposit.
- RSMMeans (Gordian Group, 2021) labor rates include overhead and profit.
- Costs for labor, monitoring, well abandonment, and maintenance were escalated to the year in which they are anticipated to be incurred. A 2.69%/year escalation rate, compounded annually, was used based on the past 5 years of RSMMeans historical cost indices (Gordian, 2021), as recommended by DOGM.

- The wellfield is staffed in 2025-2026 for rinsing operations. Employees remaining in 2027 will be employed for 3 months to close the wellfield.
- Electrical costs for wellfield rinsing were based on the current rate of \$0.06/kw-hr. Electrical costs were not escalated.
- Well abandonment costs were based on the UDOGM guidance (UDOGM, 2021), using \$5.50 per linear foot for the plugging cost, \$210 for wellhead removal, and \$12,000 for mobilization. These costs were escalated from 2021 to the year they will be incurred. The wellfield wells will be abandoned in 2027 and the monitoring wells will be abandoned in 2031 after 5 years of post-closure monitoring.
- Closure and post-closure monitoring labor costs and expenses are based on Clear Creek's experience in monitoring groundwater at mining sites. Costs for sample shipping, generator rental, mileage (from Salt Lake City) and laboratory analyses are included.
- Laboratory costs for closure and post-closure monitoring were based on a laboratory quote from a commercial laboratory, and escalated to the year the cost will be incurred. Subcontracted laboratory costs were marked up 15%, as is customary.
- Water treatment is not expected to be necessary, based on LVMC's understanding of the acid neutralizing capacity of the rock. However, the cost for sodium bicarbonate addition, including mixing equipment, is included in the bond estimate because, as the permit notes this treatment may be implemented. The mixing will be done in an existing impoundment that is included in the surface mine bond.
- Indirect costs of 21.8% were applied. This includes 5% for insurance, permits and bonds, 5% contingency, 2.5% for engineering redesign, 6.8% for main office expense, and 2.5% for project management (UDOGM Tech 007, 2017).
- The UDOGM Tech 007 (2017) guidance recommends a 10% indirect cost for mobilization (which also includes insurance, permits and bonds). Instead, we used 5% for insurance, permits and bonds (see bullet point immediately above). Mobilization costs are included in the labor and subcontractors' costs. It is worth noting that this project will require very little equipment for reclamation, since all surface reclamation will be covered by the UDOGM open pit reclamation surety, and thus mobilization costs are small. The only mobilizations are for the drill rigs (for abandonment) and monitoring staff (who we have assumed will come from Salt Lake City).

3.2 Closure Costs

Clear Creek estimates the closure costs, using the assumptions provided in Section 3.1, will be \$6,184,000. A spreadsheet summarizing the costs is attached.

4. Conclusions

Clear Creek Associates prepared this independent third-party estimate of closure costs for the first three (3) years of in situ mining at the Lisbon Valley Mining Company GTO deposit. In general, our analysis confirms the accuracy of the Company's operational closure cost estimate but differs from LVMC's estimate in the following ways:

- This estimate escalates costs from 2021 to the year in which they are expected to be incurred.
- This estimate used DOGM's guidelines for indirect costs, with the exception of mobilization costs.
- This estimate includes costs for water treatment during the second year of rinsing. LVMC's experience with leaching in the surface mine indicates this will not likely be necessary. However, because it is referenced in the UIC application as a possibility, we recommend that it be included.

5. References

Gordian Group, Inc., 2020. Heavy Construction Costs with RSMMeans data, 2021. Derrick Hale, PE, editor.

State of Utah Department of Natural Resources Division of Oil, Gas and Mining (UDOGM), 2017. Calculation guidelines for determining coal mining reclamation bond amounts, Directive number Tech-007.

State of Utah Department of Natural Resources Division of Oil, Gas and Mining (UDOGM), 2021. 2021 Reclamation Surety Amounts for Exploration and Small Mining Operations Including

Small Mine Three- and Five-Year Escalation, memo to Utah Board of Oil Gas and Mining from Wayne Western, Peter Brinton, and Kim Coburn dated March 24, 2021.

Independent Third-Party Financial Assurance Bonding Estimate
 Lisbon Valley Mine, La Sal, Utah

August 20, 2021

Closure Summary		Rinsing Y1	Rinsing Y2	FIVE YEAR POST-CLOSURE PERIOD					
		2025	2026	2027	2028	2029	2030	2031	
	Mining Area (tons)	7,521,429	7,521,429						
	Pumping Volume	359,640,000	272,975,409						
	Pore Volume Circulated (including final rinse)	3.5	2.7						
	Cume Rinsing Volume	359,640,000	632,615,409						
	Duration of Rinsing (days)	165	365						
	Wellfield Wells to Abandon			71					
	Monitor Wells to Abandon							7	
	Well Footage to Abandon			47,390					
	Monitoring Well Footage to Abandon							6,600	
	Wells Rinsing	23	23						
	\$Kwh	\$ 0.06	\$ 0.06						
Labor									
	Project Manager	250,093	256,821	65,932	-	-	-	-	
	Wellfield Supervisor	232,746	239,007	-	-	-	-	-	
	Wellfield Operations	209,616	215,254	-	-	-	-	-	
	Wellfield Ops	160,464	164,781	-	-	-	-	-	
	Wellfield Electrician	262,711	269,778	69,259	-	-	-	-	
	Laborer	153,236	157,358	40,398	-	-	-	-	
	Site Security	204,816	210,326	53,996	-	-	-	-	
	Overhead, vehicles & expenses	27,801	28,548	14,658	-	-	-	-	
	Total	1,501,483	1,541,873	244,243	-	-	-	-	
Rinsing, Capital & Power									
	Rinse Recovery Pumping Power	75,091	59,246	-	-	-	-	-	
	Evaporation Pumping Power	227,902	311,604	-	-	-	-	-	
	Water Supply Power	54,872	54,872	-	-	-	-	-	
	Total	357,865	425,722						
Water Treatment									
		-	178,969	-	-	-	-	-	
Qtrly Monitoring, Rinse Verification Sampling, and Reporting									
		47,986	49,277						
Well Rehabilitation and Maintenance									
		56,491	58,010						
Well Abandonment									
	Wellfield	-	-	337,202	-	-	-	-	
	Monitoring Wells	-	-	-	-	-	-	64,901	
	Total	-	-	337,202	-	-	-	64,901	
Post Closure Monitoring									
		-	-	65,875	67,647	69,467	71,336	73,254	
Total Closure Cost by Year of Operation		1,963,825	2,253,851	647,320	67,647	69,467	71,336	138,155	
Indirect Costs									
	Insurance, permits, bonds	5.0%	23,117	35,599	20,154	3,382	3,473	3,567	6,908
	Contingency	5.0%	98,191	112,693	32,366	3,382	3,473	3,567	6,908
	Engineering Redesign	2.5%	49,096	56,346	16,183	1,691	1,737	1,783	3,454
	RS Means Main Office Expense	6.8%	133,540	153,262	44,018	4,600	4,724	4,851	9,395
	Project Management Fee	2.5%	49,096	56,346	16,183	1,691	1,737	1,783	3,454
	Subtotal Indirect Costs	21.8%	353,040	414,246	128,904	14,747	15,144	15,551	30,118
									TOTAL FA Estimate
PROJECT TOTAL BY YEAR		2,316,864	2,668,096	776,223	82,394	84,611	86,887	168,273	6,183,349

for 50% neutralization

includes \$12000 mobe, escalated
 includes \$12000 mobe, escalated

Attachment K

Expected Changes Due to Injection

16.13 Future Operations

With future exploration drilling, there is the potential of locating additional recoverable resources within the Project Area that are outside the currently requested AEB. A future amendment for a modified AEB might be requested by the Company if additional potential well field areas are delineated.

17.0 PART O - Expected Changes Due to Injection

Expected changes due to injection include changes in aquifer chemistry, head pressures, and local gradients. All changes are transient and will be restored after mining.

17.1 Chemistry Changes

The LLV BC Aquifer chemistry and head levels will change during the ISR mining process. The anticipated groundwater chemistry within each wellfield is detailed in Section 6.3.

17.2 Head Changes

The head level changes will be the result of concurrent injection/extraction. A section is included below describing the dynamics of concurrent injection/extraction in the ISR wellfields.

17.2.1 Hydrology of ISR

ISR operation involves injection and extraction wells operating in tandem which increases flow between wells as a function of increased pressure head. The inter-well pressure head between wells is a sum of injection pressure and drawdown pressure. Stated another way, the drawdown (S_w) is equal to the increase in head above the water table at the injection well. S_w between a single extraction and single injection well is shown below. The injection well can be pressured to heads above ground surface with a surface booster pump of sufficient pressure rating and capacity.

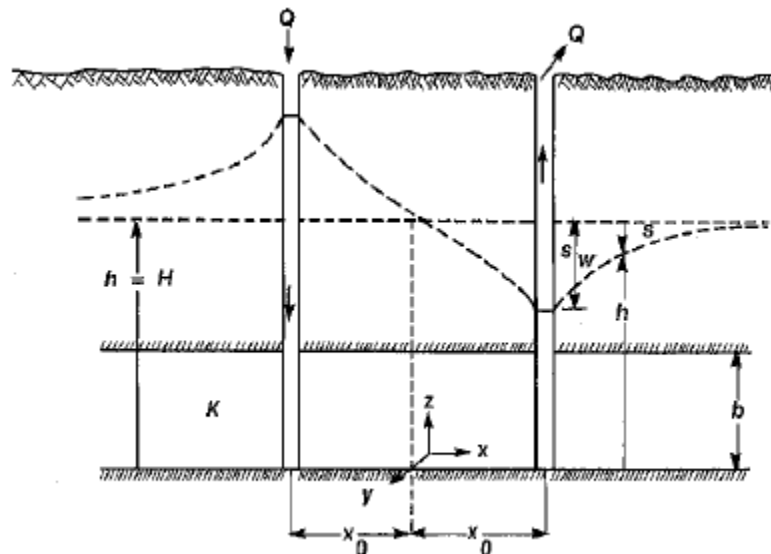

The GTO simulation is based on pump testing at PW-12, located near the deepest part of the GTO graben. Injection pressure w/o boost is simulated @ 337psi. This pressure can be boosted to 459 psi and stay 10% below 0.6 ft/ft frac gradient. The extended 5-Spot wellfield flow can be operated at flow rates greater than 50 gpm/well.

Depth Bed 15	hydrostatic ft	psi	frac psi	90% frac	delta
850	780	337.74	510	459	121.26

GTO Injection Pressure and Extended Wellfield Flow

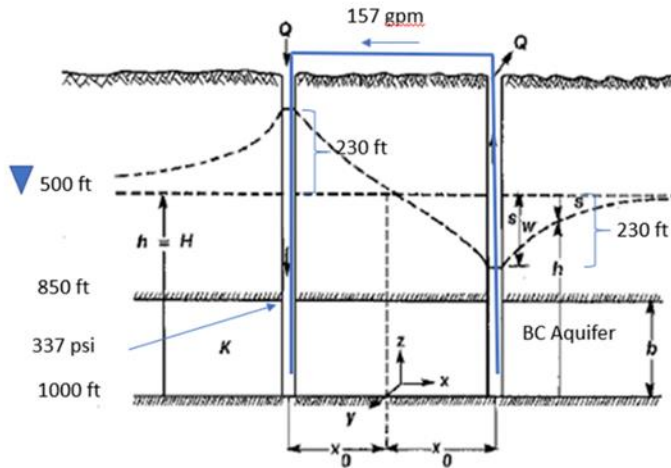

The extended five spot flow equation expressed with the intrinsic permeability and SI units is:

$$Q = \frac{k_i \Delta P_{IP}}{\mu} \left[\frac{\pi b}{\ln(S_y / \sqrt{2} r_w) - 0.619} \right] \quad (11.11)$$

$$Q = (k_i \Delta P_{IP} / m) * [pb / (\ln(S / (\sqrt{2} r_w)) - 0.619)]$$

Q	gpm	156.6877
k_i	mD	400
ΔP_{IP}	psi	130.05
m	psi*s	1.45E-07
b	ft	150
SS	ft	150
$S/\sqrt{2}$	ft	106.066
r_w	in	4

Bartlett R.W 2009 Solution Mining Leaching and Fluids Recovery of Materials Second Edition

The changes in head pressure at Lone Wolf is shown below and added to Section – of the report. The Lone Wolf simulation is based on pump testing at PW-9, a low permeability well located on the perimeter of the Lone Wolf deposit. Injection pressure w/o boost is simulated @ 100 psi. This pressure can be boosted to 135 psi and stay 10% below 0.6 ft/ft frac gradient

Depth Bed 15	hydrostatic ft	psi	frac psi	90% frac	delta
250	230	99.59	150	135	35.41

Lone Wolf Pressure Injection Pressure and Extended Wellfield Flow

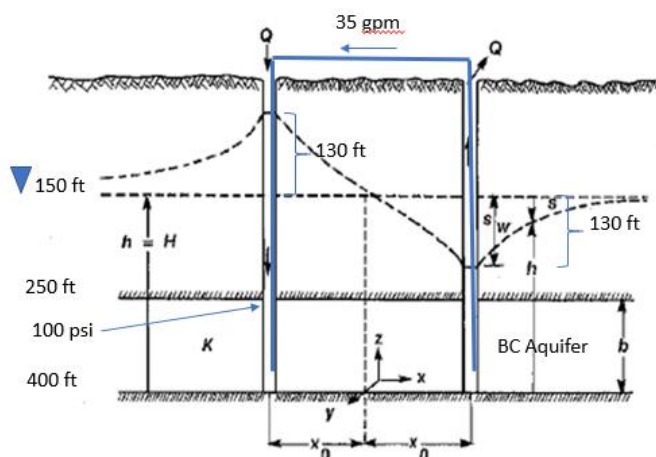

The extended five spot flow equation expressed with the intrinsic permeability and SI units is:

$$Q = \frac{k_i DP_{ip}}{\mu} \left[\frac{\pi b}{\ln(S_s/\sqrt{2}r_w) - 0.619} \right] \quad (11.11)$$

$$Q = (k_i DP_{ip}/m) \cdot [pb / (\ln(S_s/(\sqrt{2}r_w)) - 0.619)]$$

Q	gpm	35.25472
k_i	mD	90
DP_{ip}	psi	130.05
m	psi*s	1.45E-07
b	ft	150
$S_s/\sqrt{2}$	ft	106.066
r_w	in	4

Bartlett R.W 2009 Solution Mining Leaching and Fluids Recovery of Materials Second Edition

17.4 ISR Wellfield Design

Injection rates and extraction rates will be controlled during ISR operation to hydraulically capture all of the injected lixiviant and minimize excursion. The wellfield pattern, combined with flow rate controls, will capture the injected lixiviant by either operating more extraction wells than injection wells, or otherwise adjusting injection flow below extraction flow. This maintains an inwards hydraulic gradient for life of mining activities. Production monitoring wells, described in Section 12, ensure that head levels and chemistry changes are restricted to the wellfields for the life of the ISR mining process.

Attachment L

Mechanical Integrity Demonstration Protocols

10.5 Mechanical Integrity Testing

All injection, production, and monitor wells will be field tested to demonstrate the mechanical integrity of the well casing. The MIT will be performed using pressure-packer tests. The bottom of the casing will be sealed with a plug, downhole inflatable packer, or other suitable device. The casing will be filled with water and the top of the casing will be sealed with a threaded cap, mechanical seal or downhole inflatable packer. The well casing then will be pressurized with water or air and monitored with a calibrated pressure gauge. Internal casing pressure will be increased to 125 percent of the maximum operating pressure of the well field, 125 percent of the maximum operating pressure rating of the well casing (which is always less than the maximum pressure rating of the pipe), or 90 percent of the formation fracture pressure (see Section 8.1), whichever is less. A well must maintain 90 percent of this pressure for a minimum of 10 minutes to pass the test.

If there are obvious leaks, or the pressure drops by more than 10 percent during the 10-minute period, the seals and fittings on the packer system will be checked and/or reset and another test will be conducted. If the pressure drops less than 10 percent the well casing will have demonstrated acceptable mechanical integrity.

10.5.1 Loss of Mechanical Integrity

If a well casing does not meet the MIT criteria, the well will be removed from service. The casing may be repaired and the well re-tested, or the well may be plugged and abandoned. Well plugging procedures are described in Section 15. EPA will be notified of any well that fails MIT following the reporting procedures described in Section 14.5. If a repaired well passes MIT, it will be employed in its intended service following demonstration that the well meets MIT criteria. If an acceptable test cannot be demonstrated following repairs, the well will be plugged and abandoned.

10.5.2 Subsequent Mechanical Integrity Testing

In addition to the initial testing after well construction, MIT will be conducted on any well following any repair where a downhole drill bit or under-reaming tool is used. Any well with evidence of subsurface damage will require new MIT prior to the well being returned to service. MIT also will be repeated once every 5 years for all active wells.

10.5.3 Reporting

MIT documentation will include the well designation, test date, test duration, beginning and ending pressures, and the signature of the individual responsible for conducting each test. MIT documentation will be available for inspection by the EPA. MIT results will be reported on a quarterly basis as described in Section 14.5 (Attachment P).

Attachment M

Aquifer Exemption Request



State of Utah
Underground Injection Control Program
Aquifer Exemption Request
Submitted to the
U.S. Environmental Protection Agency Region 8

Prepared by the State of Utah,
Department of Environmental Quality,
Division of Water Quality

June, 2022

TABLE OF CONTENTS

List of Figures iv

List of Tables v

Key Acronyms and Definitions v

Introduction 1

Substantial or Non-Substantial Approval: Non-Substantial..... 3

Description of the Proposed Copper Recovery Process 4

 Background..... 4

 Proposed Injection, Production, and Monitoring Wells..... 7

 In-Situ Recovery Process 8

 Injectate (Lixiviant) Characteristics 9

Description of the Land Use, Geology, and Water Quality in the Permit Area 10

 Land Use in the Permit Area..... 10

 Geological Structure of the Burro Canyon Aquifer 10

 Confining Zone(s)..... 13

 Depth and Thickness of the Burro Canyon and N Aquifers..... 15

 Water Quality—Total Dissolved Solids..... 15

Permit Area for This Aquifer Exemption 17

Basis for Decision 18

 Regulatory Criteria Under Which the Exemption Is Requested 18

 Assessment of the BC Aquifer as a Source of Drinking Water 18

 A Portion of the BC Aquifer Is Not an Underground Source of Drinking Water (USDW) 18

 Private and Public Wells Within the Permit Area / Aquifer Exemption Boundary 20

 Private and Public Wells Outside the Permit Area / Aquifer Exemption Boundary 20

Mining Plan..... 24

 Commercial Producibility..... 24

 Demonstration of Amenability of Mining Method 24

 Geochemistry and Mineralogy of the Mining Zone 25

Project Timetable.....	26
Other Considerations.....	28
Natural Attenuation	28
Demonstration That the Injection Zone Fluids Will Remain Within the Aquifer Exemption	
Area	28
Vertical Confinement.....	29
Lateral Confinement	32
Monitoring Requirements	32
Decision.....	35
Conclusion.....	36
References	37

LIST OF FIGURES

Figure 1. Location of the Lisbon Valley Mining Company proposed Permit Area and Aquifer Exemption Area, Area of Review, and BC Aquifer. 5

Figure 2. Proposed Aquifer Exemption boundary, Project Area, existing water production and monitoring wells associated with current open pit mining, proposed point of compliance monitoring wells for the Permit, and GTO, Lone Wolf, and Flying Diamond copper deposits that are targets for ISR. Adapted from the Lisbon Valley Mining Company Technical Report (LVMC 2020: Figure 3.2). 6

Figure 3. Spacing between perimeter monitoring wells will be no greater than 300 feet or close enough to ensure no undetected excursions at the nearest injection well. Reproduced from the Lisbon Valley Mining Company Technical Report (LVMC 2020: Figure 11.4); also reproduced in Permit Attachment E. 7

Figure 4. Stratigraphic column of the BC Aquifer, the major confining zone (the Morrison Aquitard), and the N Aquifer. Adapted from the Lisbon Valley Mining Company Technical Report (LVMC, 2020: Figure 3.12). 11

Figure 5. Southwest to northeast cross section A–A' of the GTO and Lone Wolf Deposits in the lower Lisbon Valley. The schematic shows the Burro Canyon Aquifer, the major confining formations (Morrison and Mancos Aquitards), and the N Aquifer. Reproduced from the Lisbon Valley Mining Company Technical Report (LVMC, 2020: Figure 3.23). 12

Figure 6. The BC Aquifer, Aquifer Exemption area, hydrologic features of interest in the lower Lisbon Valley, and two wells in the AOR (outside the Permit Area). 22

Figure 7. Cross section D–D' showing the total depths of the Stevenson well 05-2970 (3-Step Hideaway domestic well) and the Wilcox well 05-3907 (Wilcox Section 10) with respect to the lower Lisbon Valley graben faults and footwall blocks (FW). The Stevenson well is outside the Aquifer Exemption boundary. The Wilcox well penetrates the Dakota Formation at the top of the BC Aquifer just outside the Aquifer Exemption boundary on the southeast (see Figure 2 and legend in Figure 5). Adapted from the Lisbon Valley Mining Company Technical Report (LVMC 2020: Figure 3-26). 23

Figure 8. Lisbon Valley Mining Company’s timetable for project development. Reproduced from Figure 11.8 of the Lisbon Valley Mining Company Technical Report (LVMC, 2020: 141). 27

LIST OF TABLES

Table 1. Major Confining Zones of the BC Aquifer in Lower Lisbon Valley..... 14
 Table 2. Depth Below Ground Surface and Thickness of the BC and N Aquifers 15
 Table 3. BC and N Aquifer Baseline Water Quality (mean values from Table 12.4 of LVMC, 2020) 34

KEY ACRONYMS AND DEFINITIONS

ADEQ	Arizona Department of Environmental Quality
AE	Aquifer Exemption
amsl	above mean sea level
AOR	Area of Review
Aquifer	a saturated bed, formation, or group of formations that yields water in sufficient quantity to be economically useful (Driscoll, 1986)
BC Aquifer	Burro Canyon Aquifer
BLM	Bureau of Land Management
Director	Utah UIC Director
Division	Division of Water Quality
DWQ	Division of Water Quality
EPA	U.S. Environmental Protection Agency
FW	footwall block, the block of rock on the lower side of a fault plane
gpm	gallons per minute
injection interval	within a well, the injection interval refers to the specific range of depths below the ground surface at which fluids will be injected into the aquifer; within the injection interval, well casing screens or perforated casing allows fluids to enter the permeable rock formation; above the injection interval, a solid casing is used

	for the well and forms a barrier between the well and the surrounding rock or aquifer
ISR	in-situ recovery
LLV	lower Lisbon Valley
LVMC	Lisbon Valley Mining Company, LLC
MCL	maximum contaminant levels
N Aquifer	Entrada, Navajo, Kayenta, and Wingate Formations, sandstone aquifers
National Instrument 43-101	National Instrument 43-101 is a national instrument for the <i>Standards of Disclosure for Mineral Projects</i> within Canada. The Instrument is a codified set of rules and guidelines for reporting and displaying information related to mineral properties owned by, or explored by, companies which report these results on stock exchanges within Canada.
mg/L	milligrams per liter
Perched water	unconfined groundwater separated from an underlying main body of groundwater by an unsaturated zone (Driscoll, 1986); in some cases it may be confined by low permeability formations above and below the perched water
Permit	Utah Division of Water Quality Class III Area Permit, Underground Injection Control (UIC) Program, UIC Permit Number: UTU-37-AP-5D5F693
SDWA	Safe Drinking Water Act
SLB&M	Salt Lake Base and Meridian
TDS	total dissolved solids
UAC	Utah Administrative Code
UIC	Underground Injection Control
USDW	underground sources of drinking water

INTRODUCTION

The Lisbon Valley Mining Company, LLC (LVMC), has submitted a permit application (LVMC, 2019) to the Utah Division of Water Quality (DWQ or Division) for work in the lower Lisbon Valley (LLV), Utah. LVMC is proposing to use a portion of the Burro Canyon (BC) Aquifer in the LLV in San Juan County, Utah, for in-situ recovery (ISR) of copper. The Director has prepared an Underground Injection Control, Class III Permit (UTU-37-AP-5D5F693), hereafter referred to as the Permit (DWQ, 2022) based on LVMC's permit application.

This Aquifer Exemption (AE) request is part of the Permit. This document provides background information and the basis for the Director's decision to request that the U.S. Environmental Protection Agency (EPA) approve an AE for a portion of the BC Aquifer. The basis of the AE request includes selected material and data contained in LVMC's Technical Report (LVMC, 2020) submitted with the permit application (LVMC, 2019), but the Technical Report, in its entirety, is not the permit or part of the permit (DWQ, 2022). The Director required LVMC to include the Technical Report as part of its application for the permit to provide information relevant to the Director's review of the application and to use when writing the Permit and this AE request. The Technical Report was provided to the public in response to a request from the public, but it is not part of this public notice package because the Technical Report itself in its entirety is not part of the Permit (DWQ, 2022) or this AE request. Moreover, LVMC revised and updated the Technical Report during the permit review process in response to requests from the Director for more information and for modifications to the proposed plan and AE request. The Final Permit (DWQ, 2022) is the legal regulatory document that defines all permit conditions. The objective of the Director's review of LVMC's application and Technical Report is not to edit, critique, and finalize those documents, but rather to use those documents to prepare the Permit and this AE request, which is subject to public notice comment under UIC regulations (40 CFR §§ 124.10, 124.11, 124.12, and 124.17 as incorporated in Utah Administrative Code [UAC] R317-7-1). Specific information from the Technical Report used to support this AE request is cited, quoted, or reproduced in this AE request.

Under Part III, Section E.1 of the Permit (DWQ, 2022), an AE and an approved Aquifer Restoration Plan are required prior to commencement of ISR wellfield construction and operations by LVMC in the LLV. LVMC provided justification for the AE in its permit application (LVMC 2019), and information in that application and Technical Report (LVMC, 2020) is used to support this AE request.

Aquifer to Be Exempted: A portion of the BC Aquifer as described herein.

Exemption Criteria: The portion of the BC Aquifer proposed for exemption qualifies under 40 CFR § 146.4 because it is not currently serving as a source of drinking water and cannot serve as a potential future source of drinking water because LVMC has demonstrated that it contains minerals that are expected to be commercially producible.

Primacy Agency: State of Utah, Department of Environmental Quality, Division of Water Quality, under Section 1422 of the Safe Drinking Water Act (SDWA) and the Utah Underground Injection Control (UIC) Rules in UAC R317-7. The Utah Bureau of Water Pollution Control, now the Utah Division of Water Quality, received primacy from EPA on February 10, 1983, according to 40 CFR §§ 145 and 147 to administer the program in Utah under section 1422 of the SDWA for Class I, III, IV, and V wells (the Utah 1422 UIC Program). All Utah UIC regulations are enforced by the Division under the authority of the Director of DWQ who is also the designated Utah UIC Director (Director).

Date of AE Request: June 2022

SUBSTANTIAL OR NON-SUBSTANTIAL APPROVAL: NON-SUBSTANTIAL

Under 40 CFR § 144.7(b)(3) and § 145.32, this AE request to EPA is a state program revision and requires EPA to determine whether approval of the AE request is a major or minor (i.e., substantial or non-substantial) amendment to Utah's UIC Program. The Director believes this AE decision is minor, or non-substantial, because it is associated with the issuance of a site-specific UIC Class III permit action, not a statewide programmatic change or a revision with implications for the national UIC program. The basis for characterizing this AE as a minor, non-substantial program revision is also consistent with the corresponding state program revision process detailed in EPA Guidance #34: *Guidance for Review and Approval of State Underground Injection Control (UIC) Programs and Revisions to Approved State Programs* (EPA, 2000). Guidance #34 explains that determining whether a program revision is substantial or non-substantial is done on a case-by-case basis and, with the exception of AEs associated with certain Class I wells or exemptions not related to action on a permit, AE requests are typically treated as non-substantial program revisions. While this is the first Class III AE in the state of Utah, there are several Class II AEs in the state.

Current Operator: Lisbon Valley Mining Company, LLC (LVMC)

Well/Project Name: Lisbon Valley In-Situ Copper Recovery Project

Well/Project Permit Number: Permit No. UTU-37-AP-5D5F693

Well/Project Location: All of Sections 4, 5, 6, 7, 8, 9, 10, 11, 14, 15, 16, and 17 of Township 31 South, Range 26 East, Salt Lake Base and Meridian (SLB&M). All of Sections 31 and 32 of Township 30 South, Range 26 East, SLB&M. All of Section 36 of Township 30 South, Range 25 East, SLB&M. All of Section 1 of Township 31 South, Range 25 East, SLB&M.

County: San Juan

State: Utah

Well Class /Type: Class III in-situ copper recovery

DESCRIPTION OF THE PROPOSED COPPER RECOVERY PROCESS

BACKGROUND

LVMC currently operates an existing open pit and heap leach copper mine in southeastern San Juan County, Utah, about 20 miles north-northeast of Monticello and east of U.S. Route 191 (Figure 1). The current Lisbon Valley mine has been using open pit and heap leaching methods for 13 years. The mine has recovered approximately 65%–75% of available copper using these methods, which are used throughout the copper industry.

Additional copper resources in the LLV are currently uneconomical to develop using open pit mining methods. Therefore, LVMC proposes to extend the life of the Lisbon Valley mine by adopting ISR technology. ISR methods involve injecting lixiviant (which is defined and explained below in the In-Situ Recovery Process section) into injection wells (classified by the Director as Class III injection wells). LVMC's proposal requires a Class III Area Permit from the UIC Director (Permit, DWQ 2022). LVMC requested this AE as part of its application for a UIC permit (LVMC, 2019). This AE request is part of the Permit, and the Director is submitting this AE request to the EPA for approval.

Figure 1 shows the Permit Area boundary in dark green and the Area of Review (AOR) considered by the Director in its permit application review in light green. Under UAC R317-7-1, the AOR extends 2 miles from the circumscribed Permit Area for an area permit.

LVMC has identified three ore bodies with commercial grades of copper suitable for ISR. Figure 2 shows the LVMC Permit Area and the Lone Wolf, GTO, and Flying Diamond deposits where ISR wellfields are proposed. Other areas with potential copper resources within the Permit Area, as indicated in Appendix D of LVMC's Technical Report (LVMC 2020: Appendix D), may also be amenable to ISR. Other copper resources that may exist in LLV outside of the area considered in the Permit cannot be developed by ISR under UIC regulations unless the Permit is revised at a future date or a separate permit is applied for and approved.

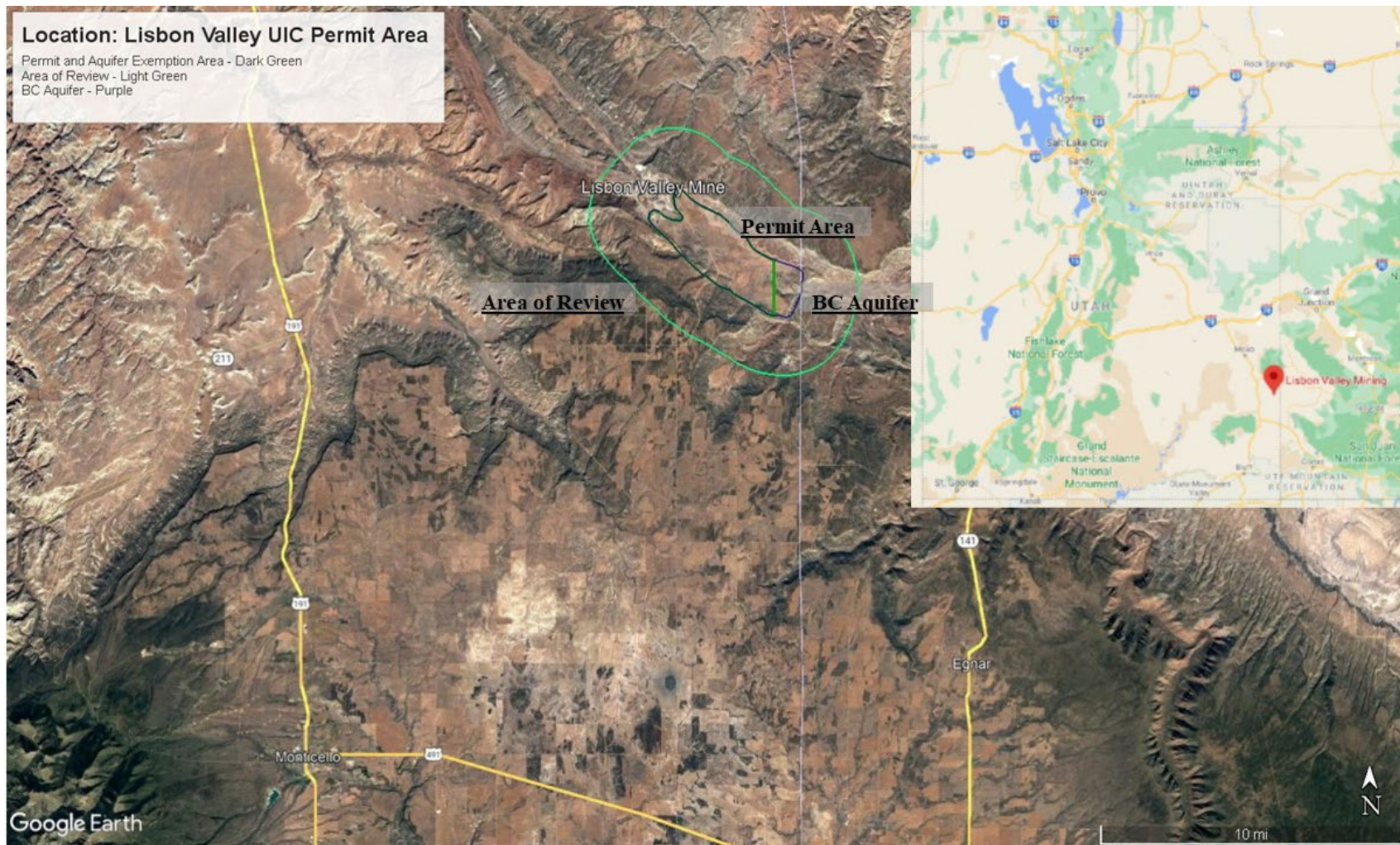

Figure 1. Location of the Lisbon Valley Mining Company proposed Permit Area and Aquifer Exemption Area, Area of Review, and BC Aquifer.

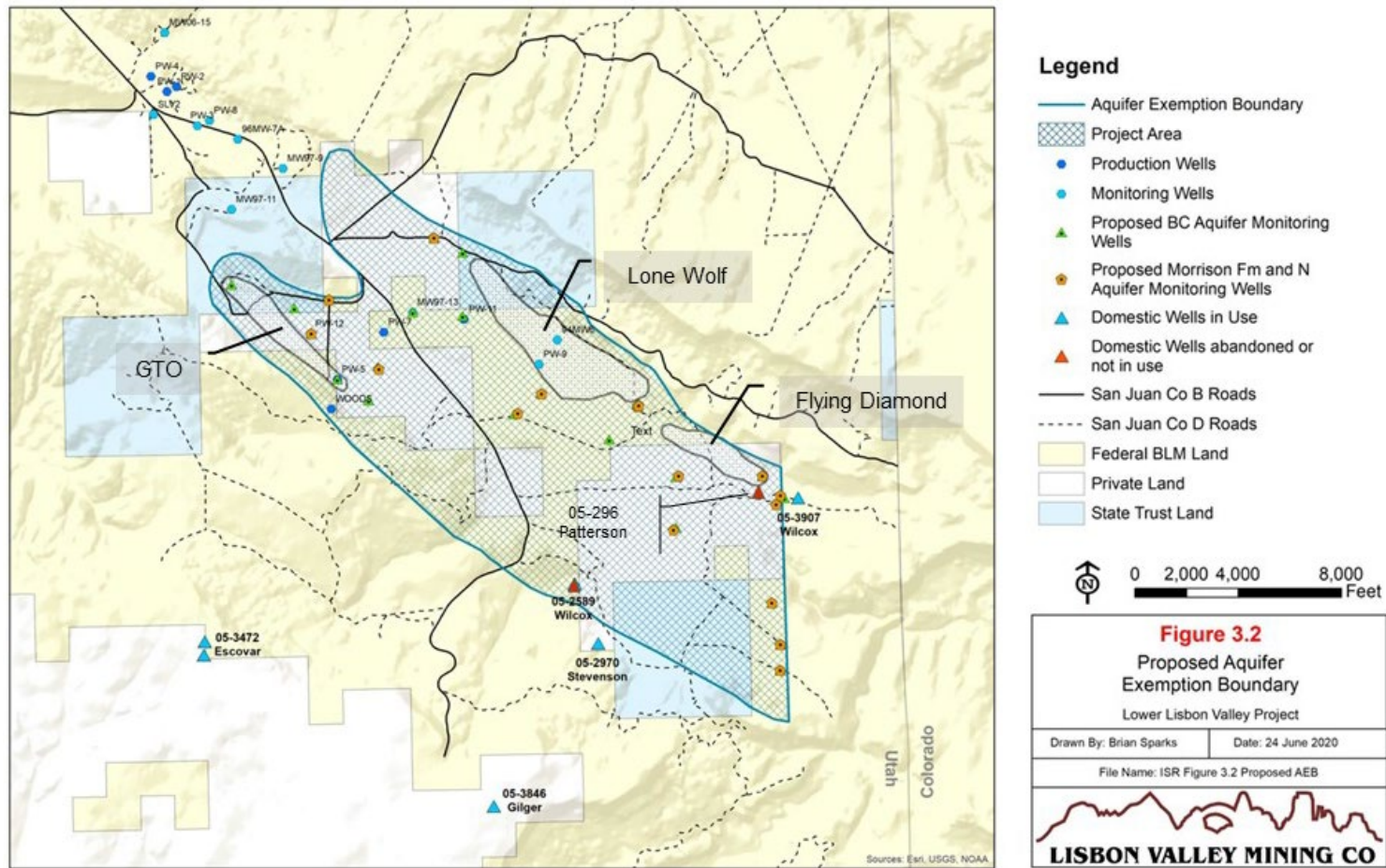

Figure 2. Proposed Aquifer Exemption boundary, Project Area, existing water production and monitoring wells associated with current open pit mining, proposed point of compliance monitoring wells for the Permit, and GTO, Lone Wolf, and Flying Diamond copper deposits that are targets for ISR. Adapted from the Lisbon Valley Mining Company Technical Report (LVMC 2020: Figure 3.2).

PROPOSED INJECTION, PRODUCTION, AND MONITORING WELLS

LVMC proposes to construct and operate up to approximately 2,650 Class III ISR injection wells to continue extraction of copper from ore in the LLV within mineralized zones of a portion of the BC Aquifer, which includes the Dakota and Burro Canyon Formations. These formations exist generally between 200 and 900 feet below the ground's surface in the LLV, east of the current mining operation.

Figure 3 shows the proposed typical arrangement of injection wells, production wells, and monitoring wells. Each ISR wellfield will have a perimeter ring of monitoring wells around the wellfield as shown in Figure 3.

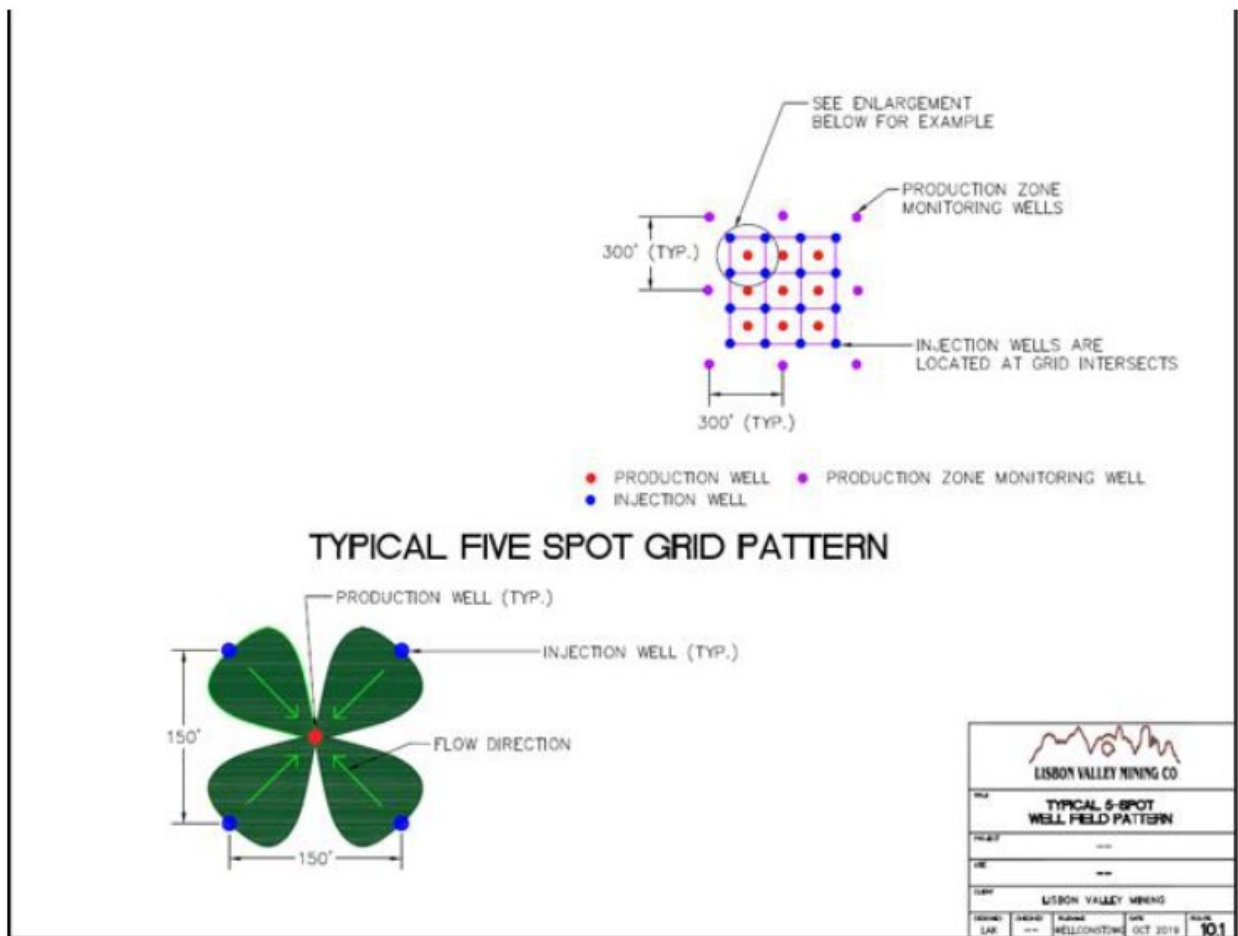

Figure 3. Spacing between perimeter monitoring wells will be no greater than 300 feet or close enough to ensure no undetected excursions at the nearest injection well. Reproduced from the Lisbon Valley Mining Company Technical Report (LVMC 2020: Figure 11.4); also reproduced in Permit Attachment E.

Each perimeter ring of monitoring wells will be located about 150 feet from the injection and production wells. Perimeter monitoring wells will be spaced approximately every 300 feet along the perimeter of the wellfield. LVMC anticipates the construction of up to approximately 200 Class III injection wells and production wells per year over the expected 20 years of ISR operations. Approximately 200 to 700 ISR wells will be operational at any given time during the project. The total rate of flow of lixiviant (which is defined below in the In-Situ Recovery Process section) that will be recirculated in the ISR wellfields ranges from approximately 5,000 to 20,000 gallons per minute (gpm).

IN-SITU RECOVERY PROCESS

If approved, this AE request would allow the injection of sulfuric acid lixiviant into the copper-bearing portions of the BC Aquifer. Injecting this solution will facilitate ISR of copper by solubilization of copper currently suspended in the copper-bearing mineral deposits within the BC Aquifer.

The ISR process involves the injection of lixiviant into a water body that contains copper ore deposits. For this project, lixiviant will consist of groundwater to which sulfuric acid and oxygen have been added. The lixiviant will be pumped into the copper-bearing portions of the BC Aquifer through the injection wells. When the lixiviant displaces groundwater in the aquifer, it will dissolve the copper within the solid matrix of the aquifer. The chemistry of copper sulfide oxidation and dissolution is characterized by the reaction:

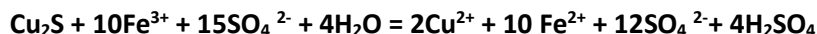

LVMC will employ an iron-based lixiviant because chalcocite (Cu_2S) is the primary form of copper in the Lisbon Valley deposits. Ferric iron will be the key leaching agent for copper ISR at the LVMC. Air or oxygen may be injected with the lixiviant to increase the amount of ferric iron in the leaching lixiviant. The lixiviant will increase total iron and ferric iron levels in the groundwater from baseline water concentrations by lowering the pH and adding dissolved air or oxygen.

Production wells will pump the copper-bearing lixiviant out of the ground. The copper-bearing lixiviant will then flow via pipeline from the wellfield to the solvent extraction plant. At the plant, gravity will be used to separate the lixiviant into copper-laden organic material and aqueous material. The insoluble organic extraction liquid will be mixed with a leach solution, and then a sulfuric acid solution will be used to extract the copper from the organic material. The copper sulfate solution will then be sent to an electrowinning facility where copper will be plated onto cathodes from the solution. The copper cathodes will be stripped to produce copper plates for commercial sale on the market. The barren lixiviant will be pumped from the solvent extraction plant back to the ISR wellfield where sulfuric acid and oxygen will be added before the solution is injected back into the copper deposits through the wellfield injection wells.

INJECTATE (LIXIVIAN) CHARACTERISTICS

The Class III Area Permit allows the following types of fluids to be injected into the Class III injection wells:

1. During the ISR process, the injection fluid is limited to ISR lixiviant consisting of SXEW raffinate (sulfuric acid solution with dissolved solids similar to current heap leach solutions) with ferric iron and oxygen added. Per the Permit, Part III, Section M, other chemicals, grout, and fresh groundwater may be injected for the purposes of facilitating the movement of or containing leach solutions and protecting domestic and livestock watering wells based on the Director's order(s) and approval(s).
2. During the groundwater restoration phase, the injectate will be limited to recycled spent leach solution and clean groundwater extracted from the post-ISR wellfields. Per the Area Permit, Part III, Section M, neutralizing agents and other chemicals may be injected for the purposes of enhancing groundwater restoration based on the Director's order(s) and approval(s).

DESCRIPTION OF THE LAND USE, GEOLOGY, AND WATER QUALITY IN THE PERMIT AREA

LAND USE IN THE PERMIT AREA

Two residences are within the Permit Area: a ranch and a seasonal bed and breakfast commercial operation. Seven people reside permanently within the Permit Area. An additional two residences are located outside the Permit Area in the AOR.

Land ownership within the AOR is roughly 80% Bureau of Land Management (BLM) (24,338 acres), 12% private (3,587 acres), and 8% State of Utah (2,552 acres). Hence, development in the area is highly restricted by the predominance of Federal jurisdiction.

The predominant land uses within the Project Area are mining and ranching. Most of the land surface serves as grazing land for cattle. Some of the land is used for recreational activities—primarily off-road motorsports and hunting. Additional studies of any surface impacts may be conducted the BLM or DOGM or other land use authority.

GEOLOGICAL STRUCTURE OF THE BURRO CANYON AQUIFER

LVMC is seeking an AE for a portion of the BC Aquifer, which includes the saturated portions of the Dakota and Burro Canyon Formations (Figure 4). The BC Aquifer is generally between 200 and 900 feet below the ground's surface in the LLV. Appendix D of the LVMC Technical Report (LVMC, 2020: Appendix D), which was submitted with LVMC's permit application, describes the perched water within the BC Aquifer as being vertically and laterally confined by the geological structure of the LLV. The geological structure is a large graben, which is a large block of land between two faults that has dropped down relative to the surrounding area. The major confining formations of the BC and the N Aquifers are illustrated in Figure 5. The N Aquifer is a sandstone aquifer in the Entrada, Navajo, Kayenta, and Wingate Formations. The N Aquifer is not artesian in the LLV, and pumping is required to bring water to the surface.

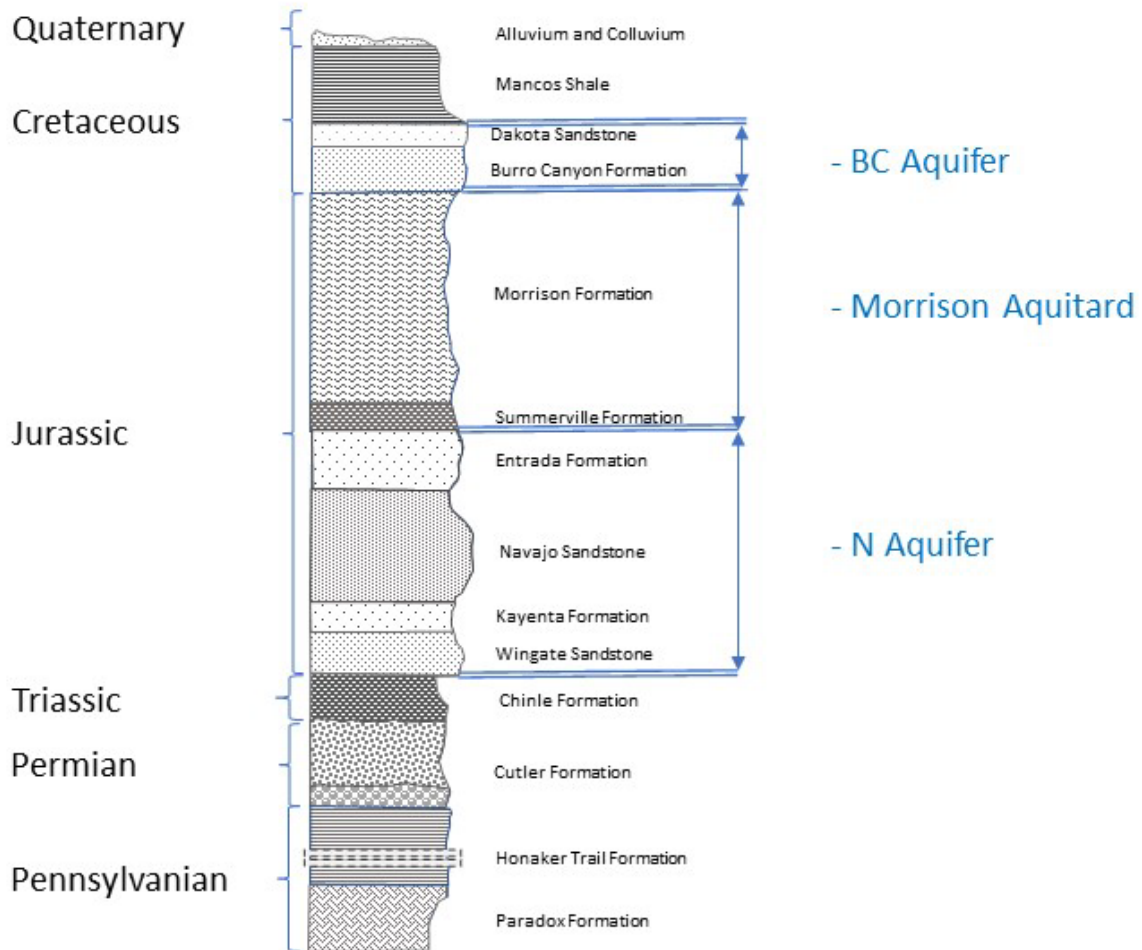

Figure 4. Stratigraphic column of the BC Aquifer, the major confining zone (the Morrison Aquitard), and the N Aquifer. Adapted from the Lisbon Valley Mining Company Technical Report (LVMC, 2020: Figure 3.12).

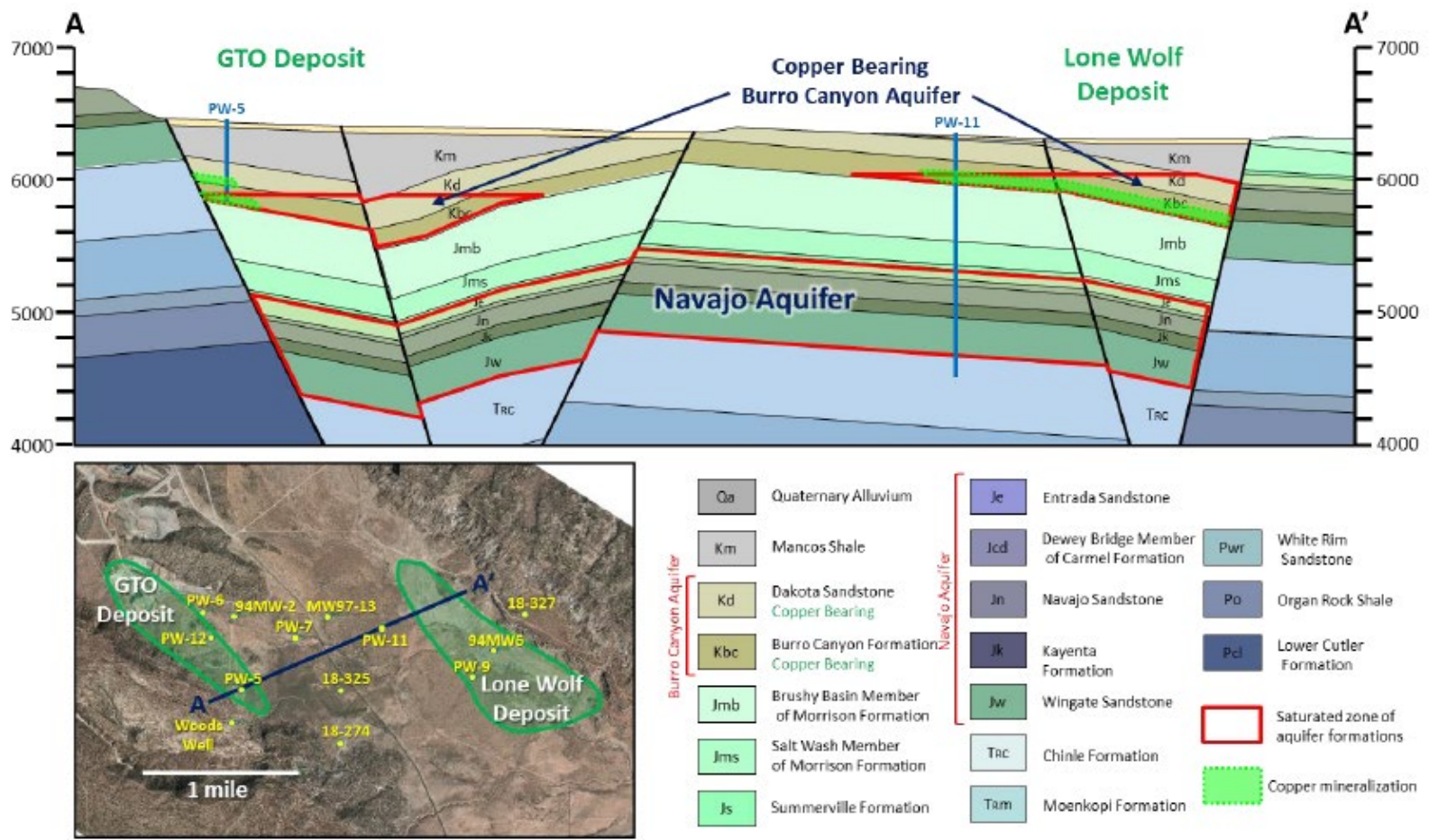

Figure 5. Southwest to northeast cross section A–A' of the GTO and Lone Wolf Deposits in the lower Lisbon Valley. The schematic shows the Burro Canyon Aquifer, the major confining formations (Morrison and Mancos Aquitards), and the N Aquifer. Reproduced from the Lisbon Valley Mining Company Technical Report (LVMC, 2020: Figure 3.23).

The LLV graben's large down-dropped structure causes groundwater in the Dakota-Burro Canyon Formations (the BC Aquifer) to be confined to those geological strata. The BC Aquifer is vertically confined by the underlying Morrison Formation and overlying Mancos Shale, both of which are unsaturated aquitards. The BC Aquifer is laterally sealed by fine-grained fault gouge on the major northeast and southwest fault sections and by the relative elevations of surrounding geologic structures.

The LLV is part of the Colorado Plateau and includes thick sedimentary stratigraphic sequences (see Figure 4) that are regionally horizontal and relatively continuous (Williams et al., 2014). However, local warping, faulting, salt doming, salt dissolution, and the collapse of overlying beds within the Paradox Formation have caused the bedded sequences to become offset. The LLV was created by normal faulting on the northeast and southwest flanks of the valley along the LoneWolf/Flying Diamond and Lisbon Valley faults, respectively. Hence, in the LLV, the BC and N Aquifers are contained within a closed basin isolated by the regional geologic anticlinal structure within a graben bounded by faults with low hydraulic conductivity owing to the occurrence of fine-grained fault gouge material (LVMC, 2020: Appendix M).

The BC Aquifer within the LLV is perched water, which means it is separated from a lower body of regional groundwater (i.e., the N Aquifer) by an unsaturated zone (Driscoll, 1986) and does not contribute to the regional groundwater system (i.e., it does not flow to the Dolores or Colorado Rivers). The N Aquifer groundwater in the LLV flows east to the Dolores River rather than west to the Colorado River, which is where the regional groundwater system flows (Avery, 1986). The N Aquifer is a much greater source of regional groundwater for southeastern Utah than the BC Aquifer (Avery, 1986).

The central part of the LLV graben is largely unsaturated where the Mancos shale has been eroded and the Burro Canyon and Dakota Formations are at ground surface or have been partly eroded owing to greater down dropping of these formations at the fault-bounded edges of the graben where the copper resources occur (see Figure 5).

Groundwater elevations range from 5,900–6,200 feet above mean sea level (amsl). Elevations have no overall regional or lateral gradient because the BC Aquifer is bounded on all sides and is segmented by block faulting within the graben. These hydrogeologic conditions exist across the entire LLV.

CONFINING ZONE(S)

Table 1 lists the major confining zones and their minimum and maximum thicknesses at wellfield locations beneath the Permit Area. The thickness values for the upper and lower confining zones for the BC Aquifer (the subject of this AE request) are based on cross sections and logs from drill holes located throughout the Permit Area. These overlying and underlying confining zones comprise shale and silty shale horizons.

Table 1. Major Confining Zones of the BC Aquifer in Lower Lisbon Valley

Injection Interval	Confining Zone Formation Name	Minimum Thickness (feet)	Maximum Thickness (feet)
GTO (Section A–A')	Upper Confining Zone: Mancos Shale	150	600
	Lower Confining Zone: Morrison Formation	350	600
Lone Wolf (Section B–B')	Upper Confining Zone: Mancos Shale	0	225
	Lower Confining Zone: Morrison Formation	450	600
Flying Diamond (Section C–C')	Upper Confining Zone: Mancos Shale	0	200
	Lower Confining Zone: Morrison Formation	600	800

Cross sections A through E from the LVMC Technical Report (LVMC, 2020: Figures 3.16–3.20) show the BC Aquifer is discontinuous, segmented by faults, and locally confined vertically and horizontally as perched groundwater. The lack of continuity within the BC Aquifer is also supported by the highly variable groundwater chemistry, given the relatively small size of the aquifer. For example, the oxygen isotope $\delta^{18}\text{O}$ ratios range from -10.2‰ to -16.5‰ and are relatively evenly distributed across that range. This is a remarkably wide range for such a small-volume and partially confined aquifer hosted by relatively homogeneous sedimentary formations. This range spans the known range of the combined surface and groundwater values in the region (LVMC, 2020: Appendix C). In contrast, the N aquifer $\delta^{18}\text{O}$ values are below the range for the BC Aquifer and vary by only about 1‰.

The isotopic data and other geochemical indicators show that the perched water in the BC Aquifer is actually composed of separate perched water zones that have very limited lateral connections among blocks via unsaturated pore connections with the N Aquifer. Hence, groundwater production from individual wells is limited to the yield from individual blocks of the BC Aquifer within the compartmentalized BC Aquifer volume.

Block faulting has compartmentalized the BC Aquifer laterally. Each wellfield will have operational vertical confining units as described in Table 1. The upper confining unit is the Mancos Shale Formation, and the lower confining unit is the Morrison Formation. In some locations the Mancos Shale (the upper confining unit) may not be present because it has been eroded in the central part of the LLV. The Morrison Formation separates the BC Aquifer from the N Aquifer, as shown in Figure 5. The formation testing

required under Part III, Section D.7, and Attachment D of the Class III Area Permit (DWQ, 2022) will verify whether these local confining units are sufficient to direct the injected lixiviant to flow through the ore deposit in the intended injection, flow, and production pattern shown in Figure 3.

DEPTH AND THICKNESS OF THE BURRO CANYON AND N AQUIFERS

In the Permit Area, the geologic strata dip variably across and along the axis of the LLV graben structure because of the normal block faulting within the graben. Therefore, the depth to the top and bottom of the BC and N Aquifers varies across the Permit Area. The local normal faulting within the LLV graben results in down-dropped blocks, which causes the depth to the top of the Dakota and BC Formations to vary locally (Table 2). The average thickness of the BC Aquifer does not vary substantially and is approximately 370 feet. Table 2 presents an approximate average depth of the BC and N Aquifer units in the Permit Area based on cross sections A through E presented in Figure 3.15 of the LVMC Technical Report (LVMC, 2020: 53) and shown in Figures 3.16 through 3.20 of the LVMC Technical Report (LVMC, 2020: 54–58).

Table 2. Depth Below Ground Surface and Thickness of the BC and N Aquifers

Cross Section	BC Aquifer Maximum and Minimum Depth and Thickness			N Aquifer Maximum and Minimum Depth and Thickness		
	Max. Depth (feet)	Min. Depth (feet)	Thickness (feet)	Max. Depth (feet)	Min. Depth (feet)	Thickness (feet)
A–A'	500	0	350	1300	450	700
B–B'	375	0	500	1400	400	900
C–C'	200	0	400	1000	900	750
D–D'	300	0	300	1400	1000	700
E–E'	50	0	300	950	800	600

Source: Data from the Lisbon Valley Mining Company Technical Report (LVMC, 2020: 53–58, Figures 3.15–3.20).

The thickness of the BC Aquifer formation is relatively constant (with an average of approximately 370 feet) across the Permit Area. Portions of the BC Aquifer are confined along the bounding faults by low-permeability Mancos Shale (see Figure 5, which is a typical northeast–southwest cross section of the LLV).

WATER QUALITY—TOTAL DISSOLVED SOLIDS

The Director evaluated the groundwater quality of the BC Aquifer within the proposed AE volume, which is the portion of the BC Aquifer within the AE boundary, with respect to drinking water quality for potential future use. A summary of analytical results from the BC Aquifer groundwater samples are included in

Table 12.4 of the LVMC Technical Report (LVMC, 2020: 155) submitted with the LVMC Permit Application (LVMC, 2019).

In the BC Aquifer, total dissolved solids (TDS) concentrations range from 542 to 5,340 milligrams per liter (mg/L) with a mean TDS of 986 mg/L (median = 1,010 mg/L). These measurements are based on 101 samples. The concentrations of other contaminants, including uranium and radioactivity, in some groundwater samples exceeded maximum contaminant levels (MCLs).

Because of the characteristics described above, BC Aquifer groundwater from some wells would necessarily require treatment by reverse osmosis, electrocoagulation, or other appropriate water treatment technology to decrease TDS, iron, manganese, and sulfate concentration below the secondary drinking water standards before it is palatable for human consumption. In addition, some BC Aquifer groundwater has high radium and gross alpha and uranium concentrations above MCLs. Radon risk is also high in the Lisbon Valley area (Black, 1993). While the BC Aquifer groundwater is treatable using best available technologies, the cost to make this relatively small and localized groundwater resource suitable for human consumption will be relatively high depending upon its location within the LLV.

In the N Aquifer, TDS ranges from 260 to 1,440 mg/L with a mean TDS of 605 mg/L (median = 540 mg/L) based on 129 samples. The TDS and other groundwater quality analyses are provided in Table 12.4 of the LVMC Technical Report (LVMC, 2020: 155) submitted with the LVMC permit application (LVMC, 2019). The concentrations of other contaminants, including uranium and radioactivity, in some groundwater samples exceeded MCLs.

PERMIT AREA FOR THIS AQUIFER EXEMPTION

The Permit Area for this AE is approximately 4,803 acres and is depicted in Figure 1 and Figure 2 of this document. The proposed Permit Area for this AE includes the location of commercially producible copper ore from the GTO, Lone Wolf, and Flying Diamond ore deposits plus a buffer zone beyond the perimeter monitoring well ring for each wellfield. The Permit Area encompasses other exploration areas of interest as well.

While the wellfield monitoring perimeter ring is located about 150 feet from the boundary of the wellfield, the horizontal extent of the proposed Permit Area includes all likely Class III ISR wellfield areas and the permit area monitoring well rings will be located approximately 1,000 feet from the wellfields.

BASIS FOR DECISION

REGULATORY CRITERIA UNDER WHICH THE EXEMPTION IS REQUESTED

Regulations in 40 CFR § 146.4(a) require that a request for an AE demonstrate that the aquifer does not currently serve as a source of drinking water.

Regulations in 40 CFR § 146.4(b)(1) require that the portion of the aquifer proposed for the AE (in this case, the portion of the BC Aquifer) cannot now and will not in the future serve as a source of drinking water because of the following characteristics:

It is mineral, hydrocarbon, or geothermal energy producing, or can be demonstrated by a permit applicant as part of a permit application for a Class II or III operation to contain minerals or hydrocarbons that considering their quantity and location are expected to be commercially producible. 40 CFR § 146.4(b)(1)

Regulation 40 CFR § 144.7(c)(1) requires a UIC Class III Permit Application that “necessitates an aquifer exemption under 40 CFR §146.4(b)(1) to furnish the data necessary to demonstrate that the aquifer is expected to be mineral or hydrocarbon producing. Information contained in the mining plan for the proposed project, such as a map and general description of the mining zone, general information on the mineralogy and geochemistry of the mining zone, analysis of the amenability of the mining zone to the proposed mining method, and a timetable of planned development of the mining zone” shall be considered by the UIC Director.

These regulatory requirements are addressed in the subsequent subsections of this document.

ASSESSMENT OF THE BC AQUIFER AS A SOURCE OF DRINKING WATER

A Portion of the BC Aquifer Is Not an Underground Source of Drinking Water (USDW)

UIC regulations in 40 CFR § 144.3 define an underground source of drinking water (USDW) as an aquifer or its portion:

- (a) (1) Which supplies any public water system; or
- (2) Which contains a sufficient quantity of groundwater to supply a public water system; and
 - (i) Currently supplies drinking water for human consumption; or
 - (ii) Contains fewer than 10,000 mg/L total dissolved solids; and
- (b) Which is not an exempted aquifer.

The portion of the BC Aquifer requested for use by LVMC does not qualify as a USDW because it does not currently supply any public water system and does not contain a sufficient quantity of water to supply a public water system. The BC Aquifer is a perched water system and is laterally and vertically confined from regional aquifer systems and USDWs. Perched water is of little importance for municipal water supplies (Goetz, 2010). Moreover, the confinement restricts groundwater recharge, and local recharge is limited owing to low rainfall (15.5 inches) and high rates of evaporation (38.8 inches) as summarized in the LVMC Technical Report, 2020 (LVMC, 2020: Appendix J). Groundwater age data presented in the LVMC Technical Report (LVMC, 2020: Table 3.4 and Appendix C) shows that the BC Aquifer groundwater has an average residence time between 3,300 and 11,000 years despite being exposed at the ground surface in some parts of the LLV. The long residence times indicate that the rate of recharge to the BC Aquifer is very low. Using a conservative (i.e. with respect to higher recharge estimates) residence time of 5,000 years, the rate of recharge can be calculated using the equation:

$$\text{Recharge} = \text{Volume} / \text{Residence Time}$$

Using a continuous BC Aquifer volume beneath the proposed Permit Area based on an average area of 220 million square feet (5,000 acres), an average saturated thickness of 370 feet, and a porosity of 25 percent, the calculated rate of BC Aquifer groundwater recharge is approximately 58 gpm. However, approximately half of the BC Aquifer area is either unsaturated or partially saturated (see Figure 5) because the entire BC Aquifer thickness is only fully saturated below an elevation of 6,200 feet amsl (LVMC, 2020: Appendix D). Hence, if it is assumed that half of the aquifer is only half saturated, then the average rate of BC Aquifer recharge is only about 43.5 gpm. The regional BC Aquifer recharge in southeastern Utah is estimated to be about 24,200 gpm (Avery, 1986), which means that the proportional amount of BC Aquifer recharge in LLV is only about 0.2 percent of the total.

The estimated rate of recharge within the BC Aquifer in the LLV (43.5 gpm) is about three times greater than the minimum criteria for a public water system (approximately 15 gpm). However, it is likely that the present rate of groundwater recharge in the LLV is much lower than it was in the Pleistocene. The oldest age of BC Aquifer groundwater is approximately 11,000 years. This was determined by C¹⁴ age dating (LVMC, 2020: Appendix C). Approximately 11,000 years ago, at the end of the Pleistocene and during the last period of alpine glaciation, the climate was much cooler and wetter than it is today. The Pleistocene climate would have resulted in greater rates of infiltration and groundwater recharge. Hence, the present-day rate of recharge is likely much lower than the average recharge calculated on the basis of the past 11,000 years.

Tritium concentration in BC Aquifer groundwater samples is near or below the method detection limit (LVMC, 2020: Appendix C). Very low levels of tritium indicate little or no modern recharge, which is consistent with the semi-arid climate of southeastern Utah. In addition, given the groundwater withdrawals from the BC Aquifer by LVMC, local ranchers, and future mining operations, the actual

amount of groundwater in the BC Aquifer available for sustainable supply to public water systems in the future is limited.

The BC Aquifer does not serve as a regional source of drinking water because of its separation from the regional system by the LLV graben. Section 4.1 of the LVMC Technical Report (LVMC, 2020: 92) documents that the boundary of the Permit Area/AE Area is 14 miles from the nearest public drinking water well.

Moreover, because most of the land is government owned, it is unlikely that the population in the area can increase to a size that would require a centralized public water system. In addition, owing to the low rate of recharge, high rate of mining use, and partial saturation (perched water), it is unlikely that the remaining BC Aquifer groundwater within the AE boundary can or will be used in the future to supply drinking water.

Private and Public Wells Within the Permit Area / Aquifer Exemption Boundary

The boundary of an aquifer exemption contains the portion of the aquifer that may be affected by the injection activity (EPA, 2019). Figure 2 shows that no domestic drinking water wells inside the Permit Area / AE boundary are currently in use. Two abandoned wells are within the Permit Area:

- The very shallow Patterson 05-296 livestock watering well (total depth of 60 feet) is recorded as a dry hole that is out of use. It is in the alluvial wash of an arroyo, not the BC Aquifer. The Patterson well draws from an isolated, perched water source within Quaternary alluvium. That source is not considered an active aquifer because it has limited water availability and is only recharged by infrequent precipitation (LVMC, 2020: Appendix J).
- The Wilcox domestic well 05-2589 that draws from the BC Aquifer is recorded as abandoned.

The technical analysis demonstrated that water within the Permit Area / AE boundary is not a current source of drinking water for any existing wells. Within the Permit Area no domestic or livestock watering wells draw from the N Aquifer because of how deep the aquifer is within the Permit Area.

Private and Public Wells Outside the Permit Area / Aquifer Exemption Boundary

When considering the capture zone for a well, it is possible that water within the Permit Area / AE boundary could serve as a current source of drinking water for wells outside the Permit Area / AE boundary. To identify any such instances, the Director looked for wells within the AOR , which extends 2 miles beyond the Permit Area / AE boundary per UAC R317-7-1.1B and R317-7-1.2B. The AOR area is greater than the minimum 0.25-mile buffer zone from the Permit Area boundary discussed in EPA

Guidance #34 (EPA, 2000). A complete inventory of wells within the AOR is included in Part C of the LVMC Technical Report (LVMC, 2020: Part C).

Figure 2, Figure 6, and Figure 7 show the locations of the two domestic drinking water wells located within the AOR but outside the Permit Area that are being used, or have been used, for drinking water:

- The Wilcox well 05-3907 is relatively shallow (151 feet) and extends only into the Dakota Formation, which is the uppermost part of the BC Aquifer (see Figure 2, Figure 4, Figure 6, and Figure 7). This well is located outside of the portion of the BC Aquifer included in the AE request—this AE request does **not** include the Dakota Formation from which the Wilcox well draws its water.
- The Stevenson well 05-2970 is located near the Permit Area / AE boundary on the southeast side of the Lisbon Valley Fault just outside the Permit Area and proposed AE boundary. Well logs show that it draws from the N Aquifer and is upgradient of the Permit Area / AE boundary and is separated from the Permit Area by the Lisbon Valley Fault on the footwall block side (see Figure 2, Figure 4, Figure 6, and Figure 7).

Well records are provided by the Utah Department of Natural Resources, Division of Water Rights (<https://waterrights.utah.gov/wrinfo/query.asp>).

Water for the City of Monticello, which is approximately 20 miles southwest of the Permit Area / AE boundary (see Figure 1), is supplied from municipal wells drawing from the N Aquifer. Furthermore, the city's water supply is hydrologically isolated from the LLV by the Lisbon Valley Fault (see Figure 6). The town of La Sal is approximately 13 miles upgradient of the LLV and is also hydrologically isolated from the LLV by the Lone Wolf / Flying Diamond Fault. The town of Egnar is located in the state of Colorado and is cross gradient from the regional groundwater flow system (Avery, 1986) and is similarly hydrologically isolated from the LLV because the BC Aquifer pinches out to the southeast (see Figure 6).

Hydrologists have determined that the occurrences of Dakota, Burro Canyon, and Navajo Formations in the Lisbon Valley down-dropped graben are separate from the regional aquifer system (Avery, 1986) that is used by La Sal, Monticello, and other towns in San Juan County (see Figure 1). Hence, groundwater withdrawals in Lisbon Valley for mining, stock watering, and irrigation will not affect water levels in wells located near La Sal or Monticello.

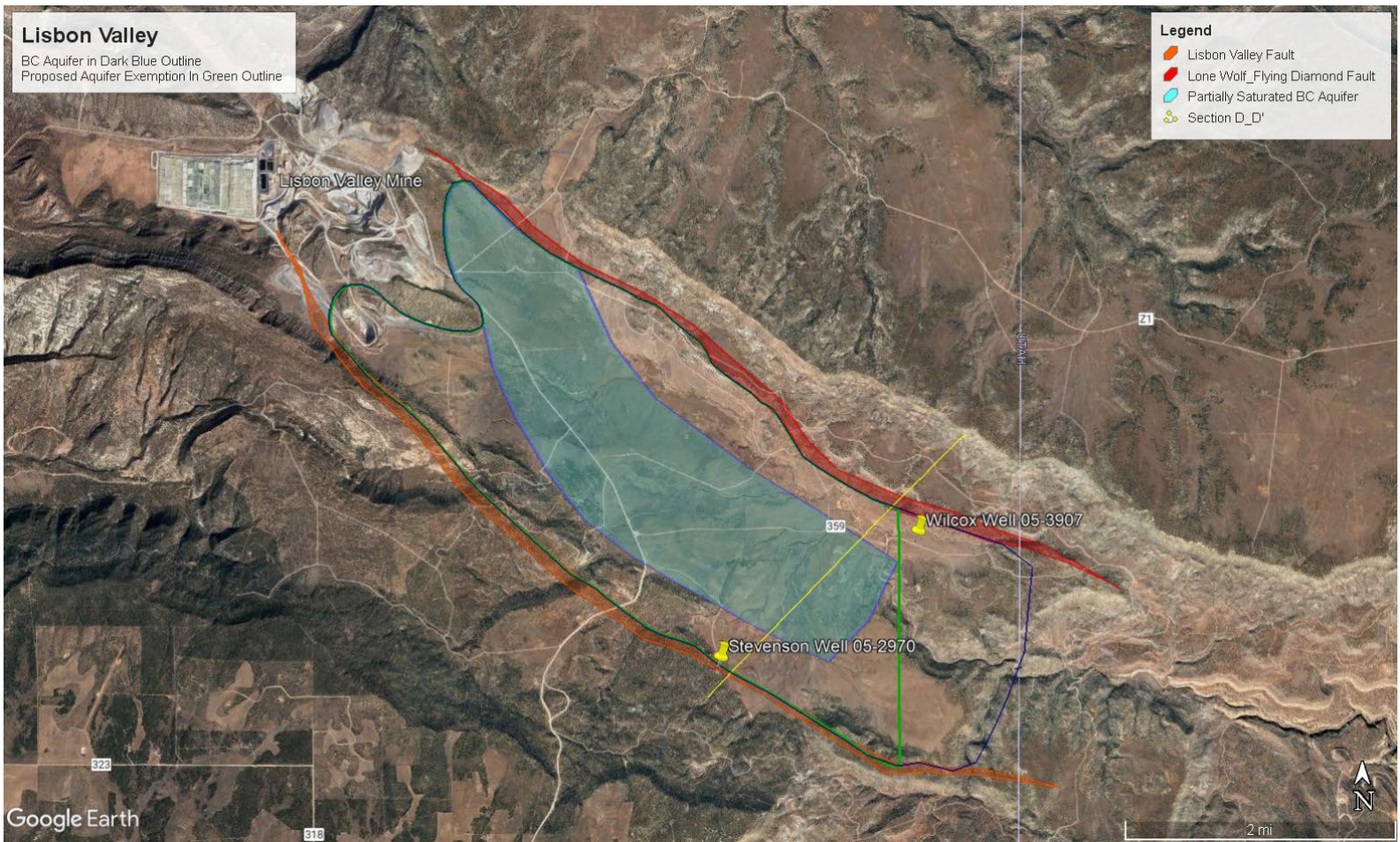

Figure 6. The BC Aquifer, Aquifer Exemption area, hydrologic features of interest in the lower Lisbon Valley, and two wells in the AOR but outside the Permit Area.

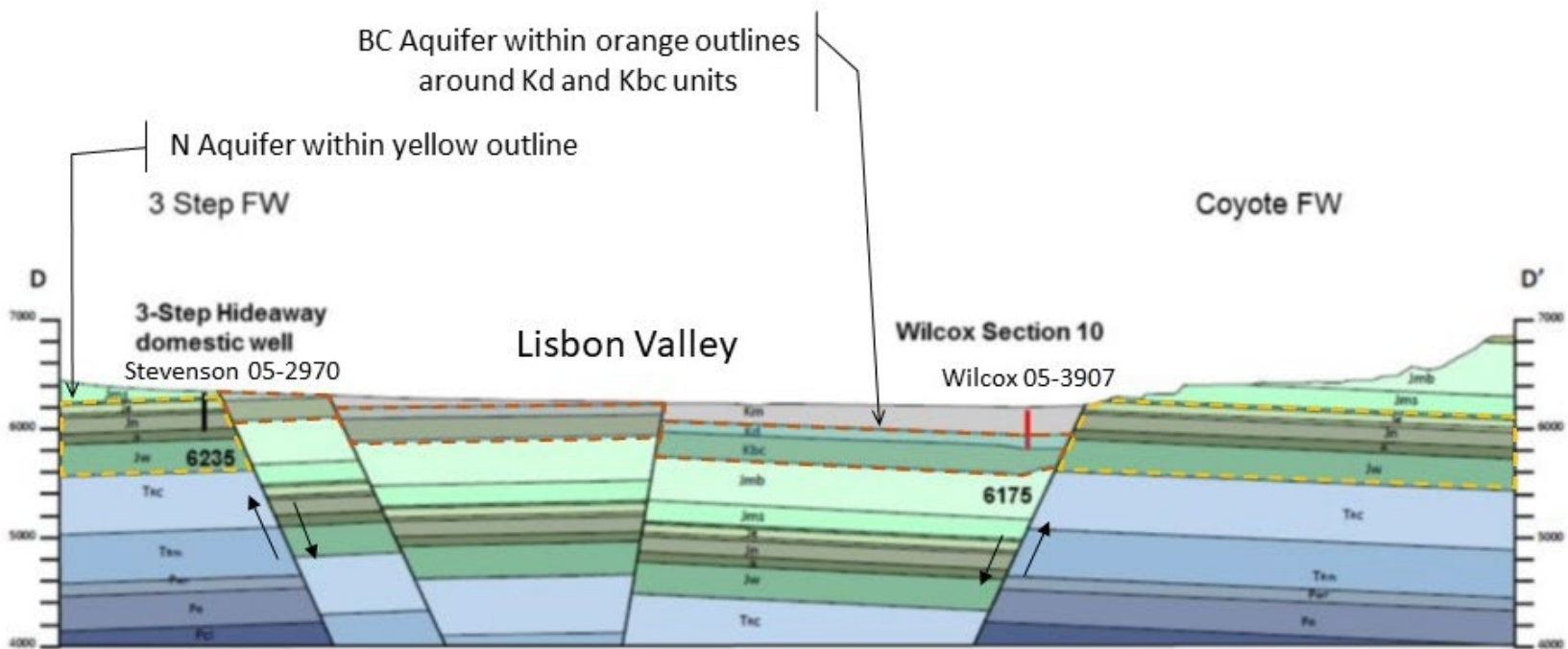

Figure 7. Cross section D–D' (see Figure 6) showing the total depths of the Stevenson well 05-2970 (3-Step Hideaway domestic well) and the Wilcox well 05-3907 (Wilcox Section 10 projected from outside the AE onto D-D') with respect to the lower Lisbon Valley graben faults and footwall blocks (FW). The Stevenson well is outside the Aquifer Exemption boundary. The Wilcox well penetrates the Dakota Formation at the top of the BC Aquifer just outside the Aquifer Exemption boundary on the southeast (see Figure 2 and legend in Figure 5). Adapted from the Lisbon Valley Mining Company Technical Report (LVMC 2020: Figure 3-26).

MINING PLAN

Commercial Producibility

The commercial producibility of acid-soluble copper from the Lower Lisbon Valley Project is demonstrated by (1) current heap leach and SXEW operations, (2) the long period of copper exploration and mine development in the area, and (3) the fact that the BC Aquifer host rock formation supports the commercial potential for copper ISR. The LVMC Technical Report (LVMC, 2020) discloses the existence of abandoned uranium mines in the AOR, and exploration for and production of uranium has occurred throughout Lisbon Valley for several decades (Chenoweth, 2006). In addition, oil and natural gas wells tap resources in the Paradox Formation in Lisbon Valley. Exploration for lithium brines is also occurring in Lisbon Valley. Hence, Lisbon Valley is a well-known mineral district for copper and other mineral resources that could be produced by drilling and well production operations that may require UIC permits.

LVMC is a private mining company and not subject to public financial and technical feasibility disclosure requirements like National Instrument 43-101. The commercial producibility of the Project is demonstrated by the extensive exploration and academic research on the Lisbon Valley Mineral District (Weir and Puffett, 1981; Hitzman et al., 2005; Hahn and Thorson, 2006; and Person et al., 2019) that has been conducted recently. These studies indicate the technical and economic feasibility of copper recovery by ISR methods within the Permit Area. The combined exploration database indicates that the existing copper resources total approximately 800 million pounds of copper suitable for ISR contained in three deposits along the northwest-to-southeast-trending Lisbon Valley mineral district (Krahulec, 2006) within the Permit Area. Additional exploration by LVMC has indicated commercial copper resource potential and is documented in information submitted with the LVMC Technical Report (LVMC, 2020: Appendix D). In addition, LVMC currently operates an SXEW plant that will be used for copper cathode production by processing of ISR pregnant leach solutions. Hence the investment risk in an ISR wellfield is very low as capital expenditures for plant construction costs are low but some plant upgrades and modifications may be necessary in the future.

Demonstration of Amenability of Mining Method

Two commercial copper ISR projects have been approved by the EPA for AEs and are operating in Arizona: the Florence (EPA, 2016) and Gunnison (EPA, 2018) copper projects. Both of these operations are UIC facilities permitted by EPA Region 9. The Dewy-Burdock uranium ISR project in South Dakota is located within the Inyan Kara aquifers, which are similar to the BC Aquifer in that the Morrison Formation is the bottom confining unit within that project area (EPA, 2020).

The lixiviant will consist of groundwater pumped from the production zone and fortified with dilute sulfuric acid and oxygen. The effectiveness of this type of lixiviant is demonstrated by leach amenability studies conducted on core samples collected within the Project Area using standard industry column testing as well as pressurized vessel testing that have demonstrated commercial copper recovery. All test work has been performed by the Company in its laboratory, and additional confirmatory third-party laboratory test work is planned. LVMC has extensive experience leaching target mineralogy in its existing open-pit heap-leach operations, which have been in operation since 2006, and which use comparable leaching metallurgy and chemistry. Furthermore, the necessary processing plant and infrastructure is already owned and operated by the Company.

Hydraulic properties of the BC Aquifer have been determined through pumping tests as described in Sections 7.2 and 7.3 of the LVMC Technical Report (LVMC, 2020: 101–105). The measurement of water levels in observation wells completed in the pumped aquifers confirmed that during all three pump tests a cone of depression formed in the pumped aquifer (LVMC, 2020: Appendix D). The development of a cone of depression verifies that hydraulic control of injection fluids (i.e., lixiviant) can be maintained within the BC Aquifer. Table D in the Groundwater Assessment section of Appendix D of the Technical Report summarizes the best estimates of hydraulic conductivity determined from these tests (LVMC, 2020: Appendix D). The average hydraulic conductivity of the BC Aquifer is approximately 2.6×10^{-4} cm/second. This hydraulic conductivity is within the range for fine or silty sandstone and the minimum hydraulic conductivity necessary for ISR without matrix modification (Bartlett, 1998). The hydraulic properties of each well will be determined prior to operations as required in the Area Permit, Part III, Section E.2 (DWQ, 2022). The aquifers are saturated in the target ore bodies, which are well suited for ISR operations.

Geochemistry and Mineralogy of the Mining Zone

The copper deposits are hosted by the clastic sedimentary rocks of the Burro Canyon and Dakota Formation as shown in Figure 5. Copper minerals are finely disseminated within the interstices of the coarse- and medium-grained sandstone units, and less common occurrences are in lenses and nodules along fractures, are around organic matter, or replace calcareous nodules or concretions, primarily within sandstone units. Extensive calcite-bearing layers have been mapped in the BC Aquifer exposures in mine pit walls at the LVMC open pit cuts (Barton et al., 2021), which may increase acid consumption, which is negative for ISR economics but positive for leach solution containment and neutralization of residual leach solution during groundwater restoration. The fine dissemination of copper mineralization in the host sandstone is ideal for ISR, which utilizes the sandstone's permeability to access fine copper mineralization with lixiviant for recovery.

The copper deposits are divided into oxide and sulfide mineralogical zones:

- Oxide/Sulfide Interface—The oxide/sulfide interface is approximately 0–250 feet below the surface, although it varies according to lithology and permeability of the individual host beds. Oxide minerals primarily include malachite, azurite, tenorite, cuprite, and other unidentified oxidized copper minerals.
- Sulfide Zone—The sulfide zone consists mainly of chalcocite or djurleite, with minor amounts of bornite and chalcopyrite on the fringes of the deposits. Chalcocite is fine-grained and “sooty” near the oxide/sulfide interface, where it might be secondary (supergene) in origin. Chalcocite disseminated in the BC Formation at depths greater than 250 feet is crystalline and steely and is primary (hypogene) in origin. Native copper is found only rarely at the oxide/sulfide interface at depth and is secondary in origin.

Copper sulfide minerals may have precipitated by reduction reactions owing to natural organic material in the ore deposit. The oxide mineralization was likely created by fluctuation of the water table and unsaturated conditions at the top of the ore zone and oxidation of primary copper sulfide minerals.

Project Timetable

The proposed timetable for project development is shown in Figure 8. LVMC anticipates that the LLV copper ore deposits will be commercially produced by ISR for approximately 20 years.

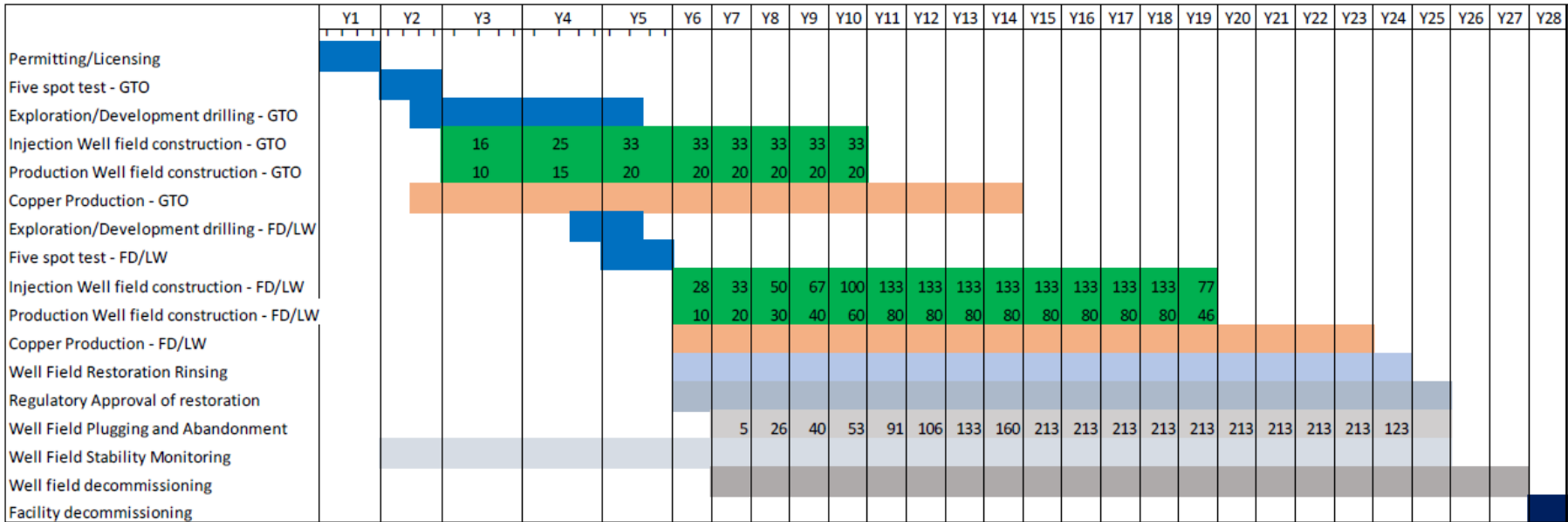
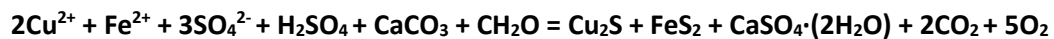

**Figure 8. Lisbon Valley Mining Company’s timetable for project development.
 Reproduced from Figure 11.8 of the Lisbon Valley Mining Company Technical Report (LVMC, 2020: 141).**

OTHER CONSIDERATIONS

NATURAL ATTENUATION

While not discussed in LVMC's Technical Report, natural attenuation will provide additional confinement of leach solutions in the ISR wellfield. The ore and formation contain natural carbonate mineralization and organic matter that will reverse the leaching reaction and neutralize leach solutions at the boundary of the wellfield(s) according to the generalized reaction:



The presence of abundant calcite (calcium carbonate) in the BC Aquifer host formations is described in the LVMC Technical Report (LVMC, 2020) and in Barton et al. (2021).

DEMONSTRATION THAT THE INJECTION ZONE FLUIDS WILL REMAIN WITHIN THE AQUIFER EXEMPTION AREA

EPA Guidance #34 states that if the exemption pertains to only a portion of an aquifer, a demonstration must be made that the waste will remain in the exempted portion (EPA, 2000). Such a demonstration should consider, among other factors, the pressure in the injection zone, the waste volume, and injected waste characteristics (i.e., specific gravity, persistence, etc.) throughout the life of the facility. Given the nature of the ISR operation, waste fluids are not being injected into the exempted portion of the aquifer. The concern in the case of the ISR operation is whether contaminants from ISR activities will cross the AE boundary laterally or migrate vertically into USDWs. A number of factors, including Class III Area Permit requirements, led the Director to the conclusion that adjacent USDWs will not be impacted by ISR contaminants crossing the AE boundary laterally or migrating vertically.

The Class III Area Permit includes the following requirements:

- Injection interval confining zones will be evaluated during pre-ISR operation wellfield pump tests for their capacity to contain injection interval fluid vertically within the approved injection interval per Permit conditions in Part III, Section E, and cited attachments (DWQ, 2022).
- LVMC must demonstrate the ability of the confining zones to contain injection interval fluids before the Director will issue an authorization to commence injection per Permit conditions in Part III, Section E, and cited attachments (DWQ, 2022).

- LVMC must demonstrate the ability of the monitoring network to detect any movement of injection interval fluids out of the approved injection interval before the Director will issue an authorization to commence injection per Permit conditions in Part III, Section G, and cited attachments (DWQ, 2022).
- Hydraulic control of the wellfield must be maintained by ensuring that the volume of lixiviant injected into the periphery of the wellfield is less than the amount of groundwater and lixiviant that is withdrawn from the production wells. Hydraulic control will be verified by continuous monitoring of injection rate and volume and the measurement of water levels in the wellfield perimeter monitoring well ring to verify a cone of depression per Permit conditions in Part III, Sections F and G, and cited attachments (DWQ, 2022). This is also consistent with Arizona Mining—BADCT Guidance for copper ISR (ADEQ, 2004).
- The extensive monitoring well network will verify both lateral and vertical containment of injection interval fluids. If any injection interval fluids begin to migrate out of the approved injection interval, the water level measurements in the monitoring well network will provide early detection to allow LVMC to implement timely corrective response actions to reverse the migration per Permit conditions in Part III, Sections C, G, and H, and cited attachments (DWQ, 2022).
- The requirements to demonstrate initial mechanical integrity for all injection, production, and monitoring wells and ongoing mechanical integrity tests for injection wells will prevent vertical migration of injection interval fluids through confining zones per Permit conditions in Part III, Sections G and I, and cited attachments (DWQ, 2022).
- Part III, Sections E, G, and J (and cited attachments), of the Permit requires LVMC to develop a groundwater restoration plan for each wellfield that includes monitoring to evaluate the long-term stability of restored ISR contaminant concentrations to ensure that no ISR contaminants cross the AE boundary (DWQ, 2022).

Vertical Confinement

Throughout most of the ore zones in the LLV, the BC Aquifer is bounded above by shale units of the Mancos Shale, which serve as the uppermost confining zone for ISR operations. However, the Mancos Shale pinches out in the center of the LLV owing to block faulting and erosion within the Lisbon Valley graben (see Table 2). Well drilling records and a shallow downward gradient within the BC Aquifer indicate that the BC Aquifer is perched water on top of the Morrison Formation. The hydraulic conductivity of the Morrison Formation Brushy Basin Member reported in the LVMC Technical Report (LVMC 2020, Section 3.8.2, p. 61) is 1.27×10^{-8} to 5×10^{-9} cm/second. The 400-foot thickness of the Morrison Formation and

the unsaturated conditions below the perched BC Aquifer result in a high degree of confinement. Fracture flow under unsaturated conditions is also low.

Distinct water chemistries for the BC and N Aquifer groundwaters presented in the LVMC Technical Report (LVMC, 2020: Appendix C) indicate that minimal communication is occurring between the BC and N Aquifers. Major ion chemistry indicates that the BC and N Aquifers have distinct geochemical signatures. Groundwater in the BC Aquifer is a Ca-Mg-SO₄-type water, and N Aquifer wells generally plot as an Na-HCO₃-type water. In addition, BC Aquifer wells, on average, had higher concentrations of ore-forming trace and base metal elements, such as cobalt, copper, iron, manganese, and uranium, than the N Aquifer wells.

Other chemical lines of evidence presented in the LVMC Technical Report (LVMC, 2020: Appendix C) include isotopic analyses, such as stable isotopes of water ($\delta^{18}\text{O}$ and δD), stable isotopes of dissolved carbon and sulfur ($\delta^{13}\text{C-DIC}$, $\delta^{34}\text{S-SO}_4$, and $\delta^{18}\text{O-SO}_4$), and $^{87}\text{Sr}/^{86}\text{Sr}$ ratios. All such evidence indicates that the BC and N Aquifers have distinct water compositions. Based on radiogenic carbon analysis, the water in the BC Aquifer has an age range of 3,300 to 11,000 years BP, while the water in the N Aquifer has an age range of 15,000 to 36,000 years BP (LVMC, 2020: Appendix C, Table 5). This also indicates a lack of connection between the BC and N Aquifers.

The depth to the top of the BC Aquifer (the Dakota Formation or Burro Canyon Formation, depending on erosion) ranges from approximately 0 feet where the Dakota and Burro Canyon Formations crop out in the central and southeastern part of the LLV to approximately 500 feet below the ground surface near the bounding faults of the LLV graben where the Mancos Formation occurs as a confining layer on top of the BC Aquifer. The Mancos Shale is considered a barrier to recharge wherever it is present. Based on various down-well methods (e.g., packer tests, bailer recovery tests, etc.) conducted around the region, hydraulic conductivity of the BC Aquifer ranges from 1.59×10^{-7} to 2.72×10^{-6} cm/second (LVMC, 2020: Appendix C). The saturated hydraulic conductivity of the Dakota Sandstone and Burro Canyon Formations ranges from 10^{-2} to 10^{-4} cm/second.

The Morrison Formation Brushy Basin Member is composed of gray and red-brown bentonitic mudstone. It is a regional confining unit with vertical saturated hydraulic conductivities ranging from about 1×10^{-8} to 5×10^{-9} cm/second (LVMC, 2020: Section 3.8.2, p. 61). However, the unsaturated hydraulic conductivity is lower, depending upon moisture content. The Brushy Basin member is approximately 400 feet thick in the Permit Area. It separates the BC and N Aquifers vertically by approximately 600 feet and creates a BC to N Aquifer head contrast ranging from 500 to 650 feet. The vertical head contrast is shown on Figures 3-26 and 3-27 of the Lisbon Valley Technical Report (LVMC, 2020: 67, 69), underscoring the robust perching characteristics of the Morrison Formation.

Part III, Sections B and E, of the Permit requires investigation of the confining zone for each wellfield through formation testing and reporting before the Director will authorize any injection activities. If a confining zone breach is caused by an improperly plugged historic exploratory borehole or a well causes a pathway through a confining zone, the Permit requires LVMC to take corrective action (see DWQ 2022: Part III.C and Attachment C) to prevent the breach from resulting in the vertical migration of injection interval fluids out of the injection interval. Exploration records from the Utah Department of Natural Resources, Division of Oil Gas and Mining, indicate that most of the exploration activity has occurred in the BC Aquifer zones, but some limited deeper drilling has likely occurred outside the bounding faults of the LLV graben where uranium mineralization is present in the Chinle Formation below the N Aquifer (see Figure 4). Hence, these boreholes into the Three-Step footwall block (see Figures 6 and 7) are separated from the AE volume and BC Aquifer by low hydraulic conductivity fault gouge. In addition, hydraulic head is higher on the footwall block side such that any groundwater seepage through the fault would flow towards Lisbon Valley and not towards the N Aquifer.

To verify that no wellfield fluids migrate vertically out of the approved injection interval, monitoring wells will be completed within each wellfield in the overlying and underlying hydrogeologic units above and below the ISR injection interval. Hydraulic control will be verified by continuous monitoring of injection rate and volume and the measurement of water levels in the wellfield perimeter monitoring well ring (see Figure 3). Furthermore, the Permit and AE will require LVMC to verify containment per Permit conditions in Part III, Sections F and G, and cited attachments (DWQ, 2022). Even though the Morrison Formation is a thick and impermeable confining zone, the Permit requires monitoring of the aquifer underlying the Morrison Formation during wellfield operation and restoration. In addition, the Permit requires observation wells below the Morrison Formation in the N Aquifer to be monitored to verify the containment of the Morrison Formation as a confining zone in the AE volume. These wells will be monitored during wellfield operation, after ISR groundwater restoration, and after restoration monitoring to detect any potential vertical migration of ISR solutions out of the approved injection interval. The Director may require additional overlying or underlying monitoring wells beyond the network shown in Figure 2 to detect potential vertical excursions in areas where the integrity of a confining zone is in question. If any injection interval fluids begin to migrate out of the approved injection interval, the water level measurements in the monitoring well network will provide early detection to allow LVMC to implement timely corrective response actions to reverse the migration per Permit conditions in Part III, Sections C, G, and H, and cited attachments (DWQ, 2022). The Permit requires LVMC to demonstrate mechanical integrity for all wells installed, including injection, production, and monitoring wells, to ensure that the cement-filled annulus between the well casing and drillhole wall does not contain any channels that could potentially allow migration of injection interval fluids out of the injection interval through confining zones.

Lateral Confinement

The portion of the BC Aquifer included in this AE is bounded by the Lone Wolf/Flying Diamond Fault and extensions on the northeast and the Lisbon Valley Fault and extensions on the southwest that formed the LLV graben. Fault gouge analyses conducted under Dr. Krantz at the University of Arizona are summarized in the LVMC Technical Report (LVMC, 2020). These analyses concluded that the bounding graben faults have very low hydraulic conductivity and laterally confine the BC Aquifer in the Permit Area. It is noted that copper mineralization is also limited within the Permit Area by these faults, which may have formed a structural trap for the mineralized fluids that formed the deposit (Krahulec, 2006).

In addition, cross sections A through E from the LVMC Technical Report (LVMC, 2020: Figures 3.16–3.20) show the BC Aquifer is discontinuous and segmented and confinement of perched water is local. Hence, the BC Aquifer in the AE volume is likely discontinuous. As summarized in the LVMC Technical Report, previous work completed at LVMC indicates that lateral flow in the BC Aquifer is influenced by geologic structures (i.e., faults; LVMC, 2020: Figures 3.24), which prevent flow and compartmentalize the BC Aquifer into many disconnected blocks. These blocks will be managed individually or as wellfield segments. In addition, the Permit requires LVMC to demonstrate and maintain hydraulic control of injection fluids during the copper recovery process and post-ISR groundwater restoration. To accomplish this, the wellfield pumping rate in the perimeter pumping wells must exceed the injection rate and result in a net extraction of injection interval fluids and groundwater that flows towards the wellfield (DWQ 2022: Part III, Section F). Continuous monitoring of injection and production flow rates and volume is required for each wellfield to verify that these conditions are being met (DWQ, 20220: Part III, Section G).

The net extraction of injection interval fluids and groundwater creates a cone of depression within each wellfield indicating that an inward hydraulic gradient is pulling groundwater into the wellfield. The measurement of water levels in observation wells during the pump tests performed by LVMC demonstrate that a cone of depression formed in the pumped aquifer during the pump tests (LVMC, 2020: Appendix D). The presence of a cone of depression verifies that hydraulic control of injection interval fluids can be maintained within the BC Aquifer. The required monitoring of water levels in the wellfield perimeter monitoring well ring will verify whether the cone of depression is being maintained during wellfield operations and post-ISR groundwater restoration (DWQ, 2022: Part III, Section G).

Monitoring Requirements

A combination of monitoring and response actions required during the operational, the post-ISR groundwater restoration, and the post-restoration phases will ensure that any effects from the ISR operations will remain within the exempted portion of the aquifer. Monitoring wells will be installed in and around each wellfield, up- and down-gradient, and in overlying and underlying aquifers to detect the potential migration of ISR solutions away from the approved injection interval.

The Permit operating conditions in Part III, Section F, and Attachment E, require LVMC to maintain hydraulic control of injection interval fluids within each wellfield at all times to prevent horizontal movement of lixiviant out of the wellfield and include a rigorous monitoring program to verify hydraulic control (DWQ, 2022: Part III, Section G, and Attachment F).

Baseline water quality parameters for the BC and N Aquifers are stated in Table 3. Analytical results of groundwater samples collected from the overlying and underlying monitoring wells required in the Permit may provide additional baseline water quality data from which the compliance limits for the overlying and underlying aquifers may be revised if new data indicates that the baseline concentrations in Table 3 are statistically different with the acquisition of additional data (DWQ, 2022; Part II Section D.6.a.1.ii).

Table 3. BC and N Aquifer Baseline Water Quality (mean values from Table 12.4 of LVMC, 2020)

Major Ions and Water Quality Indicator Parameters	Units	BC Aquifer, Mean	N Aquifer, Mean
Alkalinity dissolved, as CaCO ₃ equivalents	milligrams per liter	144	259
Alkalinity, as CaCO ₃ equivalents	milligrams per liter	282.6	265.3
Bicarbonate, as CaCO ₃ equivalents	milligrams per liter	279	261
Carbonate, as CaCO ₃ equivalents	milligrams per liter	5	3
Hydroxide, as CaCO ₃ equivalents	milligrams per liter	3	2
Hardness	milligrams per liter	433	219
Calcium	milligrams per liter	103	53.3
Magnesium	milligrams per liter	42.4	20.6
Potassium	milligrams per liter	9.5	7.2
Sodium	milligrams per liter	146	121
Chloride	milligrams per liter	23	64
Fluoride	milligrams per liter	0.5	0.6
Silica	milligrams per liter	10.9	14.4
Sulfate	milligrams per liter	463	150
Sodium Absorption Ratio	percent	1.70	3.66
Total Dissolved Solids	milligrams per liter	986	605
Total Suspended Solids	milligrams per liter	832	509
pH		7.8	7.8
Electrical Conductivity	micro seimens per centimeter	1358	951
Nutrients			
Phosphorous total, as P equivalents	milligrams per liter	0.03	0.33
Nitrate dissolved, as N equivalents	milligrams per liter	0.16	0.07
Nitrite dissolved, as N equivalents	milligrams per liter	0.01	0.01
Ammonium	milligrams per liter	0.24	0.15
Dissolved Metals			
Aluminum	milligrams per liter	0.06	0.05
Antimony	milligrams per liter	0.0014	0.0024
Arsenic	milligrams per liter	0.0035	0.0091
Barium	milligrams per liter	0.034	0.151
Beryllium	milligrams per liter	0.0004	0.0004
Cadmium	milligrams per liter	0.0076	0.0005
Chromium	milligrams per liter	0.0015	0.0046
Copper	milligrams per liter	0.01	0.01
Iron	milligrams per liter	1.37	0.85
Lead	milligrams per liter	0.0019	0.0018
Manganese	milligrams per liter	0.153	0.349
Mercury	milligrams per liter	0.0002	0.0002
Molybdenum	milligrams per liter	0.04	0.08
Nickel	milligrams per liter	0.01	0.44
Selenium	milligrams per liter	0.002	0.002
Silver	milligrams per liter	0.01772	0.01191
Strontium	milligrams per liter	3.13	2.93
Thallium	milligrams per liter	0.0005	0.0006
Uranium,	milligrams per liter	0.0395	0.0113
Vanadium	milligrams per liter	0.007	0.007
Zinc	milligrams per liter	0.15	0.50
Radiological			
Gross Alpha total	picocuries per liter	73	24
Gross Beta total	picocuries per liter	63	34
Radium 226 total	picocuries per liter	7	1
Radium 228 total	picocuries per liter	3	2
Thorium 228 total	picocuries per liter	1	0
Thorium 230 total	picocuries per liter	3	1
Throrium 232 total	picocuries per liter	1	0

DECISION

LVMC provided mineral exploration information to the Director to support the conclusion that the proposed Permit Area / AE Area within the BC Aquifer cannot now and will not in the future serve as a source of drinking water. Furthermore, the dominance of Federal land ownership in the LLV and the combined legal, technical, and economic challenges to the development of wells capable of producing enough water to sustainably supply public water systems from the proposed AE volume support the Director's determination that the BC Aquifer is not a USDW.

The Director reviewed the information provided by LVMC and has concluded that the portion of the BC Aquifer proposed for exemption does not currently serve as a source of drinking water. Based on the information reviewed, the Director has determined that the following regulatory criterion has been met:

40 CFR § 146.4(a) *It does not currently serve as a source of drinking water.*

LVMC demonstrated in the Class III permit application for the copper ISR operation that the portion of the aquifer proposed for exemption contains minerals in a quantity and location that is expected to be commercially producible.

The portion of the BC Aquifer proposed for the AE cannot now and will not in the future serve as a source of drinking water because of the following characteristics:

40 CFR § 146.4(b)(1) *It is mineral, hydrocarbon, or geothermal energy producing, or can be demonstrated by a permit applicant as part of a permit application for a Class II or III operation to contain minerals or hydrocarbons that considering their quantity and location are expected to be commercially producible.*

The Director's findings indicate that this portion of the BC Aquifer may be exempted as a source of underground drinking water based on UAC R317-7-4 and following the procedures and requirements outlined in 40 CFR § 144.7 and 40 CFR § 146.4. The exemption is subject to approval by the EPA UIC Program Administrator following public notice and comment per 40 CFR § 144.7(b)(3).

CONCLUSION

The Director requests this exemption pursuant to Aquifer Exemption criteria in 40 CFR § 144.7 and 40 CFR § 146.4 and based on strong evidence for natural containment as well as operational containment systems required in the Permit (DWQ, 2022). Based on review of the information LVMC provided, the Director finds that exemption criteria in 40 CFR § 146.4(a) and § 146.4(b)(1) have been met. Therefore, the Director is seeking EPA approval of the AE request as a minor/non-substantial program revision for the AE area and volume depicted in Figure 2.



07/05/2022

John K. Mackey, P.E.
Director, Water Quality Division

Date

DWQ-2022-017757

REFERENCES

- ADEQ. 2004. Arizona Mining Guidance—BADCT Arizona Department of Environmental Quality, Publication #TB-04-01. https://static.azdeq.gov/wqd/app_badctmanual.pdf.
- Avery, C. 1986. USGS Bedrock Aquifers of Eastern San Juan County, Utah, State of Utah Department of Natural Resources. Technical Publication No. 86.
- Bartlett, R.W., 1998. Solution Mining. Leaching and Fluid Recovery of Materials. Routledge, New York.
- Barton, I.F., M.J. Gabriel, J. Lyons-Baral, M.D. Barton, L. Duplessis, and C. Roberts. 2021. Extending geometallurgy to the mine scale with hyperspectral imaging- a pilot study using drone- and ground-based scanning. Mining Engineering, June 2021, p. 48–50.
- Black, B.D. 1993. The Radon-Hazard-Potential-Map of Utah. Map 149, Utah Geological Survey, Utah Division of Natural Resources.
- Chenoweth, W.L., 2006. Lisbon Valley, Utah’s largest uranium district. In Mining Districts of Utah, edited by R. L. Bon, R. W. Gloyne, and G. M. Park, 534–550. Utah Geological Association Publication 32.
- Driscoll, F.G., 1986. Groundwater and Wells. Johnson Filtration Systems Inc., St. Paul, Minnesota.
- DWQ, 2022. Utah Division of Water Quality Class III Area Permit Underground Injection Control (UIC) Program, UIC Permit Number: UTU-37-AP-5D5F693. Permit issued to Lisbon Valley Mining Company, L.L.C., June 2022.
- EPA. 2016. Underground Injection Control Program Area Permit, Class III In-Situ Production of Copper Permit No. R9UIC-AZ3-FY11-1. Florence Copper Project, 1575 West Hunt Highway, Florence, Arizona 85132. Issued to Florence Copper Inc., 1575 West Hunt Highway, Florence, Arizona 85132.
- EPA. 2019. Fact Sheet on Aquifer Exemption Data. EPA 810-S-16-009. June 2019.
- EPA, 2018. Underground Injection Control Program Area Permit, Class III In-Situ Production of Copper Permit No. R9UIC-AZ3-FY16-1. Gunnison Copper Project Cochise County, Arizona. Issued to Excelsior Mining Arizona, Inc. Concord Place, Suite 300 2999 North 44th Street Phoenix, Arizona 85018.
- EPA. 2000. Guidance for Review and Approval of State Underground Injection Control (UIC) Programs and Revisions to Approved State Programs. U.S. Environmental Protection Agency, GWPB Guidance #34. https://www.epa.gov/sites/default/files/2018-08/documents/guidance_34.pdf.

EPA, 2020. U.S. EPA Region 8 Underground Injection Control Program Aquifer Exemption Record of Decision for the Dewey-Burdock Uranium In-situ Recovery (ISR) Site in Custer and Fall River Counties in South Dakota. https://www.epa.gov/sites/production/files/2020-11/documents/epa_dewey-burdock_final_aquifer_exemption_decision_rod_nov_24_2020.pdf.

Goetz, C. 2010. Drawdown patterns resulting from pumping well in leaky perched aquifers. Thesis for Masters of Hydrology, New Mexico Institute of Mining and Technology, Socorro, New Mexico. December 2010.

Hahn, G.A. and Thorson, J.P., 2006. Lisbon Valley, Utah's largest uranium district, in Bon, R.L., Gloyd, R.W., and Park, G.M., editors, Mining Districts of Utah: Utah Geological Association Publication 32, p. 511-533.

Hitzman, M., Kirkman, R., Broughton, D., Thorson, J., and Selley, D., 2005. The sediment-hosted stratiform copper ore system, in Hedenquist, J.W. and Thompson, J.F.H., Goldfarb, R.J. and Richards, J.P. editors, Economic Geology 100th Anniversary Volume: Littleton Colorado, Society of Economic Geologist, p. 609-642.

Krahulec, Ken. 2006. Lisbon Valley copper project: Utah's newest copper mine. Utah Geological Survey, January 1, 2006, accessed December 28, 2018, URL geology.utah.gov/map-pub/survey-notes/lisbon-valley-copper-project/.

LVMC. 2019. State of Utah Underground Injection Control Program Class III Permit Application Package for In-Situ Copper Recovery. Lisbon Valley Mining Company LLC. December 23, 2019.

LVMC. 2020. Class III Underground Injection Control Permit Application Technical Report. Prepared by Lisbon Valley Mining Company LLC, Lower Lisbon Valley LLV Project. September 29, 2020.

Person, Mark, Jennifer McIntosh, Grant Ferguson, Dolan Lucero, Robert Krantz, Steve Lingrey, Amanda Hughes, P. Reiners, Jon Thorson, and Mark Barton. 2019. Hydrologic Constraints on Lisbon Valley Copper Mineralization Within The Paradox Basin, Utah. GSA 10.1130/abs/2019AM-334816.

Wier, G.W., and W. P. Puffett. 1981. Incomplete manuscript on stratigraphy and structural geology and uranium-vanadium and copper deposits on the Lisbon Valley area, Utah-Colorado: U.S. Geological Survey Open-File Report 81-0039.

Williams, F., L. Chronic, and H. Chronic. 2014. Roadside Geology of Utah, Mountain Press Publishing Company, Missoula.



**FACT SHEET AND STATEMENT OF BASIS
UNDERGROUND INJECTION AND CONTROL (UIC) CLASS III AREA PERMIT**

UTU-37-AP-5D5F693

**FINANCIAL ASSURANCE AND
AQUIFER EXEMPTION FOR A PORTION OF THE
BC AQUIFER IN LOWER LISBON VALLEY**

JUNE, 2021

FACILITY CONTACTS

Person Name: George Shaw
Position: Director and Chairman
Phone Number: (435) 355-0755

Facility Name: Lisbon Valley Mining Company LLC
Organization Mailing Address: PO Box 400
Moab, UT 84532
Telephone: (435) 686-9950

Actual Address: Highway 191
La Sal, UT 84532

DESCRIPTION OF FACILITY

The Lisbon Valley Mine is currently an existing open pit heap leach copper mine and processing facility operated by Lisbon Valley Mining Company LLC (LVMC) and proposes to construct and operate Class III in-situ copper recovery injection wells in south central San Juan County, Utah about 20 miles north northeast of Monticello and east of Highway 191 to extend the life of the Lisbon Valley Mine and expand operations. LVMC plans to continue extraction of copper from ore within mineralized zones of a portion of the BC aquifer (including the Dakota and Burro Canyon Formations) generally between 200 and 900 feet below the ground's surface in Lower Lisbon Valley.

SUMMARY OF CHANGES FROM PREVIOUS PERMIT

The Utah Division of Water Quality (Division) has prepared this Draft Fact Sheet and Statement of Basis (FSSOB) for the draft Underground Injection Control (UIC) Class III Area Permit (Permit) for LVMC. Pursuant to the Utah UIC administrative rules in Utah Administrative Code R317-7 et. seq. and federal regulations in Title 40 of the Code of Federal Regulations (CFR) incorporated by R317-7-1 the purpose of this FSSOB is to briefly describe the principal facts and the significant factual, legal, methodological and policy questions considered in modification of the Permit.

**FACT SHEET AND STATEMENT OF BASIS
UIC CLASS III AREA PERMIT
UTU-37-AP-5D5F693**

After reviewing the public comments on the Permit and the Fact Sheet Statement of Basis (hereafter referred to as FSSOB), and associated documents in the permit record, DWQ has determined that more detail and specification are needed with respect to two aspects of the Permit: (1) the proposed Aquifer Exemption Request (Permit Attachment M) and (2) the proposed financial assurance mechanism (Permit Attachment J). Specifically, the Division requested that the operator obtain and provide a third-party financial assurance estimate. The estimate resulted in a modified financial assurance amount. In addition, the Division has revised the Aquifer Exemption Request to more clearly outline the basis for approval of the exemption request. The modified elements of the Permit (Attachments M and J) address previous public comments on the Permit. The Aquifer Exemption is subject to approval by the US Environmental Protection Agency (EPA) following public notice and comment.

The Division has identified aquifers that may be exempted as sources of underground drinking water following the procedures and based on the requirements outlined in [40 CFR 144.7](#) and [40 CFR 146.4](#). Public comments received by the Division will be incorporated into the exemption request record submitted to the EPA.

PERMIT DURATION

It is recommended that this permit be effective until December 31, 2026.

Purpose of the Statement of Basis and Fact Sheet

To meet these objectives, this FSSOB contains:

- Background information on the permit process and names and telephone numbers of contacts for additional information (listed on the first page of this FSSOB above);
- A description of the draft permit review process and public participation;
- A brief discussion of the facility and process;
- Basis for draft permit conditions;
- A brief discussion of Lisbon Valley's aquifer exemption request and approval process.

PUBLIC NOTICE

The modified Aquifer Exemption Request (Permit Attachment M) and (2) the proposed financial assurance mechanism (Permit Attachment J) have been prepared by the Division for public notice and public comment. Public comments will be accepted by the Division for 30 days following the first day of public notice in the local newspaper that serves the affected community. A hearing may be held by the Division if public comments are substantial and the Draft Permit requires revision based on these comments.

**FACT SHEET AND STATEMENT OF BASIS
UIC CLASS III AREA PERMIT
UTU-37-AP-5D5F693**

Public Comment Began: **December 8, 2021**

Ended: **February 8, 2022**

Comments will be received at: 195 North 1950 West
PO Box 144870
Salt Lake City, UT 84114-4870
Via email at: dearley@utah.gov

The Public Notice of the modified Permit Attachments was published on the Division of Water Quality's website: <https://deq.utah.gov/public-notices-archive/water-quality-public-notices>.

ADDENDUM TO FSSOB

During finalization of the Permit certain dates, spelling edits and minor language corrections were completed. Due to the nature of these changes they were not considered Major and the Permit is not required to be re Public Noticed.

DWQ-2022-017813

**Statement of Basis and Fact Sheet for an Underground Injection and Control
(UIC) Class III Draft Area Permit
FINAL
June, 2022**

**Lisbon Valley Mining Company, LLC
PO Box 400
Moab, Utah 84532**

Lisbon Valley Mine, San Juan County, Utah



Figure 1. Lisbon Valley mine site location and UIC Permit Area.

<p><u>Location:</u> San Juan County, Utah</p>	<p><u>Operator:</u> Lisbon Valley Mining Company, LLC</p>
<p><u>Facility Contact:</u> George Shaw Director and Chairman Lisbon Valley Mining Company LLC PO Box 400 Moab, UT 84532 gshaw@lvmcholdings.com 801.435.355.0755</p>	<p><u>Regulatory Contact:</u> Dan Hall Utah Department of Environmental Quality Division of Water Quality UIC Program 195 North 1950 West Salt Lake City, UT 84116 dhall@utah.gov Tel. 801.536.4356</p>

Purpose of the Statement of Basis and Fact Sheet

The Utah Division of Water Quality (Division) has prepared this draft Fact Sheet and Statement of Basis (FSSOB) for the draft Underground Injection Control (UIC) Class III Area Permit (Draft Permit) for Lisbon Valley Mine Company, LLC (Lisbon Valley). Pursuant to the Utah UIC administrative rules in Utah Administrative Code R317-7 et. seq. and federal regulations in Title 40 of the Code of Federal Regulations (CFR) incorporated by R317-7-1 the purpose of this FSSOB is to briefly describe the principal facts and the significant factual, legal, methodological and policy questions considered in preparing the draft permit. To meet these objectives, this FSSOB contains:

- Background information on the permit process and names and telephone numbers of contacts for additional information (listed on the first page of this FSSOB above);
- A description of the draft permit review process and public participation;
- A brief discussion of the facility and process;
- Basis for draft permit conditions;
- A brief discussion of Lisbon Valley's aquifer exemption request and approval process.

Permit Process

Application and Review Period

Early in 2020 Lisbon Valley applied to the Division to obtain a Class III UIC Area Permit to construct and operate injection wells for in situ copper recovery in San Juan County, Utah. This is the first operation of its kind proposed in Utah but other operations have been permitted in Arizona. Class III UIC area permits are renewed on a regular five-year cycle. However, the permit is subject to revision or revocation at any time if permit conditions are not met based on a determination by the Division Director. The draft permit area is shown in Figure 1 and the 2 mile area of review that has been investigated for any potential impacts to underground sources of drinking water from the project and the permit conditions that are necessary to prevent them. Division completed its review and has completed the provisionally approved Draft Permit which includes stringent injection zone monitoring, well construction and testing methods, wellfield operation and closure practices.

Public Participation

The draft permit was prepared by the Division for public notice and public comment. Public comments will be accepted by the Division for 30 days following the first day of public notice in the local newspaper that serves the affected community. A public hearing may be held by the Division if public comments are substantial and the Draft Permit requires revision based on these comments.

Description of the Facility and Process

Brief Description of the Facility

Lisbon Valley is currently an existing open pit heap leach copper mine and proposes to construct and operate Class III in-situ copper recovery injection wells in south central San Juan County, Utah to continue extraction of copper from ore within mineralized zones of the Burro Canyon aquifer (including the Dakota and Burro Canyon Formations) generally between 200 and 900 feet below the ground's surface. These resources are currently uneconomical to develop using open

pit mining methods and Lisbon Valley is planning to extend the life of mine by adopting in situ copper recovery technology. A general location map is included in the inset to this Fact Sheet and Statement of Basis (Figure 1).

In-Situ Copper Recovery

The injectate is raffinate produced by the Solvent Extraction Electrowinning (SXEW) facility that is currently used to recover copper metal from leach solutions. Raffinate is initially barren of copper and consists of a dilute sulfuric acid solution containing other dissolved minerals like iron to assist in copper recovery. Makeup water and sulfuric acid is added to the raffinate to regenerate the solution for the in-situ recovery process. The raffinate is injected into the ore zone of the Burro Canyon aquifer using injection wells. The dilute acid and iron solution dissolves copper minerals in the ore and the copper bearing solution is recovered by pumping wells which return the solution to the SXEW plant where copper is recovered and turned into copper cathode by electroplating. The barren raffinate solution is then regenerated and recirculated to the in-situ copper recovery wellfield in a closed loop circuit. LVMC estimates (LVMC, 2020 Technical Report) that the average injection rate per injection well in the first phase of the project (GTO wellfield) will be 50 to 100 gallons per minute in 26 injection wells balanced by production from 45 extraction wells plus a fractional amount (1 to 5 percent) of excess pumping to maintain an inward hydraulic gradient.

Permit Conditions

Part I of the permit is the Authorization to Construct and Inject. Part II includes all general permit conditions required in all UIC permit with the focus on Class III permits. Part III contains all the specific permit conditions required of all Class III solution mining permits and particularly for Lisbon Valley.

Lisbon Valley's application is consistent with standard permit conditions and requirements in R317-7. The Division has developed permit conditions for the UIC Class III In-Situ Copper Recovery area permit is to ensure compliance with the Utah UIC administrative rules for Class III injection well activities, R317-7. Additionally, the in-situ minerals recovery and environmental industries have standards for the construction, development and monitoring of wells and which were used to develop draft permit conditions where they apply to the injection, recovery and containment of solutions. Permit conditions also require plugging and abandonment of the wells plus post closure rinsing of the wellfield.

The following references were used for developing the draft permit conditions:

- Arizona Mining Guidance – BADCT, Arizona Department of Environmental Quality. https://static.azdeq.gov/wqd/app_badctmanual.pdf
- EPA, 2016. Underground Injection Control Program Area Permit, Class III In-Situ Production of Copper Permit No. R9UIC-AZ3-FY16-1. Gunnison Copper Project Cochise County, Arizona. Issued to Excelsior Mining Arizona, Inc. Concord Place, Suite 300 2999 North 44th Street Phoenix, Arizona 8501. <https://www.epa.gov/uic/uic-class-iii-situ-production-copper-permit-no-r9uic-az3-fy16-1-excelsior-mining-arizona-inc>
- ASTM D5092 / D5092M - 16 Standard Practices for Design and Installation of

Groundwater Monitoring Wells.

<https://www.astm.org/Standards/D5092.htm>

- EPA, 2016. Underground Injection Control Program Area Permit, Class III In-Situ Production of Copper Permit No. R9UIC-AZ3-FY11-1. Florence Copper Project, 1575 West Hunt Highway Florence, Arizona 85132. Issued to Florence Copper Inc., 1575 West Hunt Highway Florence, Arizona 85132.

<https://www.epa.gov/uic/uic-class-iii-situ-production-copper-permit-no-r9uic-az3-fy11-1-florence-copper-project-florence>

Because Utah does not have specific statutes and regulations for the construction and operation of in-situ recovery wells and well fields, in general, and for copper recovery, specifically, the Division used in-situ copper recovery UIC permits issued by the EPA Regions 8 and 9 and the state of Arizona's Best Available Discharge Control Technology (BADCT) guidance manual as guidance for the writing of this draft permit. Moreover the Draft Permit is justified on the basis of the limited extent and use of the Burro Canyon aquifer in the proposed permit area, the occurrence of mineralization of potential commercial value and relatively poor water quality. The Burro Canyon aquifer is contained within a closed water recharge system by the regional geologic anticlinal structure within a graben bounded by faults with low hydraulic conductivity owing to the occurrence of fine grained fault gouge material. In addition, vertical confinement of injectate is enhanced by the Mancos and Morrison formations, both having shale beds with low hydraulic conductivity, that lie stratigraphically above and below the Burro Canyon aquifer, respectively, and are considered to be aquitards in the regional hydrogeology of the area. Furthermore Lisbon Valley will overproduce solution from production wells in order to maintain an inward hydraulic gradient and contain leach solutions within the permit area. Monitoring wells will be installed to ensure that no injectate or leach solution escapes from the wellfields and permit area. Any vertical migration will also be detected by deep monitor wells within the Morrison and Navajo Formations. Groundwater restoration will commence after in-situ copper recovery operations by rinsing the wellfield with fresh water.

Aquifer Exemption Request

Lisbon Valley is seeking an Aquifer Exemption for the Burro Canyon Aquifer beneath the permit area (Figure 1) according to R317-7-4 and the Division has identified aquifers that may be exempted as sources of underground drinking water following the procedures and based on the requirements outlined in [40 CFR 144.7](#) and [40 CFR 146.4](#). The exemption is subject to approval by the Environmental Protection Agency (EPA) UIC Program Administrator following public notice and comment. Public comments received by the Division will be considered and changes may be incorporated into the exemption request record submitted to the EPA.

DWQ-2022-017852



Lisbon Valley Mining Company LLC
Aquifer Exemption Request and Financial Assurance
Associated with
Underground Injection Control (UIC) Class III Draft Area
Permit No. UTU-37-AP-5D5F693
Utah Department of Environmental Quality
Division of Water Quality
Public Comments and Responses
Public Hearing and Comment Period from:
December 8, 2021, to February 8, 2022

Prepared by the State of Utah,
Utah Department of Environmental Quality,
Division of Water Quality

June, 2022

TABLE OF CONTENTS

Attachments..... ii
Key Acronyms and Definitions ii
I. Introduction 1
 Public Comment 1
II. DWQ Response to Comments..... 2

ATTACHMENTS

Attachment A Written Public Comments in Original Formats

KEY ACRONYMS AND DEFINITIONS

ADEQ	Arizona Department of Environmental Quality
AMA	American Motorcyclists Association
AE	Aquifer Exemption
BADCT	Best Available Demonstrated Control Technology
BC Aquifer	Dakota and Burro Canyon Formations, sandstone aquifers
BDR	Backcountry Discovery Routes
BLM	Bureau of Land Management
CFR	Code of Federal Regulations
COHVCO	Colorado Off-highway Vehicle Coalition
Division	Utah Department of Environmental Quality, Division of Water Quality
DOG M	Utah Department of Natural Resources, Division of Oil, Gas and Mining

Draft Permit	Utah Division of Water Quality Class III Area Permit Underground Injection Control (UIC) Program, UIC Permit Number: UTU-37-AP-5D5F693. Permit issued to Lisbon Valley Mining Company, L.L.C., October 2020
DWQ	Utah Department of Environmental Quality, Division of Water Quality
EIS	Environmental Impact Statement
EPA	U.S. Environmental Protection Agency
ESSD	Eastland Special Services District
FSSOB	Fact Sheet and Statement of Basis
GRAMA	Government Records Access and Management Act
ISR	In Situ Recovery
LVMC	Lisbon Valley Mining Co. LLC
N Aquifer	Entrada, Navajo, Kayenta, and Wingate Formations, sandstone aquifers
NEPA	National Environmental Policy Act
POC	Point of Compliance
SDWA	Safe Drinking Water Act
SEIS	Supplemental Environmental Impact Statement
SGR	Shale Gouge Ratio
SITLA	School and Institutional Trust Lands Administration
UIC	Underground Injection Control
USDW	Underground Sources of Drinking Water
UWSC	Uranium Watch / Sierra Club

I. INTRODUCTION

PUBLIC COMMENT

Initially, the Division of Water Quality (DWQ¹ or Division) held a Public Comment and Hearing on the LVMC UIC ISR Draft Permit and Aquifer Exemption from October 31, 2020 to January 11, 2021 (First Comment Period). The notice for the comment period was advertised in the San Juan County Record and posted on the DWQ website. In November of 2021, DWQ provided detailed responses to the comments received: <https://deq.utah.gov/water-quality/utah-underground-injection-control-uic-program>. As a result of the comments, DWQ elected to revise the Aquifer Exemption Request and request the operator obtain a third-party financial assurance estimate. The revised AE and financial assurance were similarly the subject of a Public Comment period from December 8, 2021 to February 8, 2022 and Public Hearing on January 19, 2022 (Second Comment Period). The initial, and 2022, DWQ website postings can be found here: <https://deq.utah.gov/water-quality/lisbon-valley-mining-co-llc>.

After carefully reviewing the comments from both the first and second comment period, the Division is satisfied that the UIC permit and AE meet all regulatory requirements and both are supported with sufficient documentation for issuance. None of the comments demonstrated any clear failure of factual determinations made by DWQ in the permit or AE. Additionally, the Division is satisfied that the UIC permit along with the natural geology and hydrogeology of the in-situ mining area are highly protective of groundwater and the existing beneficial uses.

¹ For convenience, the term DWQ or Division refers to the Division of Water Quality and its Director.

II. DWQ RESPONSE TO COMMENTS

The text of each comment is presented in italics and are reported verbatim. Some of the comments are divided into subparts to make it easier for the reader to connect specific parts of longer comments with the relevant portion of the Division's response. DWQ Responses are **bolded**.

Comments submitted by: Sarah Fields-Uranium Watch, Bekah Ashley-Utah Chapter Sierra Club, and Jennifer Thurston-INFORM, February 8, 2022, written comments. Carly Ferro-Utah Chapter Sierra Club, January 15, 2021.

1. Comment:

We write to oppose the Aquifer Exemption requested by the Lisbon Valley Mining Co. LLC (LVMC) in conjunction with the proposed Class III Underground Injection Control (UIC) Permit for an in situ leach (ISL) copper recovery operation. The DWQ should deny the LVMC Aquifer Exemption Request and not submit the DWQ Aquifer Exemption Request to the EPA Region 8, based on the following:

a. There is an inherent risk of irreparable harm from the proposed ISL copper recovery project.

DWQ Response:

No Permit or AE Request changes are necessary based on DWQ responses to public comments, Group Comment 1, dated November 8, 2021 in DWQ-2021-027922.

2. Comment:

b. The Burro Canyon Aquifer in the Lower Lisbon Valley is a current and future source of drinking water.

DWQ Response:

The portion of the Burro Canyon (BC) aquifer defined in the Aquifer Exemption (AE) request is not a current or future source of drinking water as explained in the AE, Section Basis for Decision, pp. 18-23.

3. Comment

c. The Burro Canyon Aquifer in the Lower Lisbon Valley is a current and future source of drinking water.

DWQ Response:

The portion of the BC aquifer being requested for exemption in the AE request is not a USDW or a source of drinking water.

4. Comment

d. The DWQ's review of the Class III UIC Permit and Aquifer Exemption Requests does not meet U.S. Environmental Protection Agency (EPA) requirements.

DWQ Response:

Per the AE request, Sections Introduction and Substantial or Non-Substantial Approval, and Non-Substantial sections, pp 1-3, the AE request meets all US EPA requirements under UIC regulations 40 CFR § 144.7(b)(3) and § 145.32 and 40 CFR §§ 124.10, 124.11, 124.12, and 124.17 as incorporated in Utah Administrative Code [UAC] R317-7-1.

5. Comment

e. The November 4, 2020, and December 8, 2021, Fact Sheet and Statement of Basis (FSSOB) do not meet the EPA 40 C.F.R. Section 124.8 requirements for a UIC Permit fact sheet.¹

DWQ Response

The December 8, 2021 AE request and Bond FSSOB will be modified to meet all EPA and CFR Section 124.8 requirements. The November 4, 2020 Permit FSSOB has been responded to and is no longer open for comment.

6. Comment

f. The DWQ has not established a Bonding Estimate and factual basis for a Bonding Estimate. DWQ has established a bonding estimate based on the third-party cost estimate provided by Clear Creek and Associates. The FSSOB and third-party cost estimate document provides the factual basis for the bonding estimate.

¹ <https://www.law.cornell.edu/cfr/text/40/124.8>

7. Comment

g. The proposed Aquifer Exemption does not meet EPA requirements for an Aquifer Exemption.

DWQ Response

The proposed AE request meets US EPA requirements for an AE as explained in the AE request, Section Basis for Decision, pp 18-23.

8. Comment

h. The proposed Aquifer Exemption violates Utah Rule R317-7-5. Prohibition of Unauthorized Injection.

DWQ Response

The AE does not violate UAC R317-7-5 because the AE request only pertains to injection via UIC Class III wells under the conditions of the Permit and is thereby authorized under UAC R317-7-5.1.

9. Comment

i. The draft DWQ Aquifer Exemption Request to be submitted is incomplete and misleading and does not provide a sufficient basis for EPA approval of the proposed Aquifer Exemption.

DWQ Response

The proposed AE request meets US EPA requirements for an AE as explained in the AE Request, Section Basis for Decision, pp 18-23.

10. Comment

j. The LVMC is not a financially stable and responsible entity.

DWQ Response

This comment was explained in the DWQ response to public comments ([November 8, 2021 Comment Responses](#)) dated November 8, 2021 under the Group Comment 2 as “The Division does not have the authority to regulate beyond the governing UIC statute and regulations,

which require financial assurance but do not otherwise impose any requirements about financial or tax status.”.

11. Comment

k. The DWQ does not have the information necessary to determine the long-term consequences of the proposed ISL Project.

DWQ Response

The relevant matter for this public notice and comment is that DWQ requested that the operator obtain and provide a third-party financial assurance estimate for the Permit. The estimate resulted in a modified financial assurance amount that ensures mitigation of long-term impacts to groundwater within and outside the AE to protect USDWs in the event of LVMC insolvency.

12. Comment

l. The non-exempt aquifers adjacent to the proposed Aquifer Exemption area is entitled to protection under the Safe Drinking Water Act (SDWA).

DWQ Response

DWQ agrees with this comment.

13. Comment

m. The DWQ has not shown that there will not be horizontal and vertical migration of contaminants from exempted aquifer into the adjacent non-exempt underground sources of drinking water (USDWs).

DWQ Response

DWQ has provided a series of data-driven results in the AE request that there has not been detectable vertical movement in the geologic history of the BC and N Aquifers and that there will not be horizontal and vertical migration of contaminants from the AE. These results are found in the AE Request, Section Other Considerations, Demonstration That the Injection Zone Fluids Will Remain Within the Aquifer Exemption Area, pp 28- 33.

14. Comment

2.1. Purpose of the Fact Sheet and Statement of Basis

The December 8, 2021, DWQ Draft Fact Sheet and Statement of Basis, Underground Injection Control (UIC) Class III Area Permit for LVMC. UTU-37-AP-5D5F693 Financial Assurance and Aquifer Exemption for a Portion of the BC Aquifer in Lower Lisbon Valley does not meet the EPA requirements for a Fact Sheet and Statement of Basis (FSSOB).

The December 2021 FSSOB is supposed to provide information related to the new additions to the Class III Area Permit: (1) the proposed Aquifer Exemption Request to be submitted to the EPA (Permit Attachment M) and (2) the proposed financial assurance mechanism (Permit Attachment J). The FSSOB is not adequate and does not meet EPA requirements, as will be discussed below.

The FSSOB states that the the purpose of the “FSSOB is to briefly describe the principal facts and the significant factual, legal, methodological and policy questions considered in modification of the Permit.” The 3-page FSSOB provides little information about the Aquifer Exemption and does not provide any evaluation of the proposed financial assurance mechanism. The FSSOB fails to describe the significant legal, methodological, and policy questions considered in the adoption of Permit Attachments J and M. The FSSOB does not meet the EPA requirements for a UIC Permit fact sheet at 40 C.F.R. Part 124.

2.2. EPA Regulations

EPA regulation applicable to UIC Permits and State Programs, such as the DWQ regulation of UIC Permits, are found at 40 C.F.R. Part 124. Section 124.8 provides the requirements for a UIC Permit fact sheet:

(b) The fact sheet shall include, when applicable:

(1) A brief description of the type of facility or activity which is the subject of the draft permit;

DWQ Response

A description of the proposed in situ copper recovery project was described in the December 8, 2021 FSSOB.

15. Comment

(2) The type and quantity of wastes, fluids, or pollutants which are proposed to be or are being treated, stored, disposed of, injected, emitted, or discharged.

DWQ Response

The type of fluids which are proposed to be injected into Permit Class III wells was provided but the quantity was not. The quantity of fluids will be dependent upon Permit Compliance Schedule in Part III.B.1 Construction Plan, which refers to Part III.D.7 Formation Testing, which will inform the Construction Plan under Part III.D and therefore provide a basis for estimation of the quantity of injectate through measurement of injection capacity and aquifer formation permeability via aquifer pump testing and other tests conducted in newly constructed wells. Total Injectate quantities will increase as the project progresses but LVMC estimates (LVMC, 2020 Technical Report) that the average injection rate per injection well in the first phase of the project (GTO wellfield) will be 50 to 100 gallons per minute in 26 injection wells balanced by production from 45 extraction wells plus a fractional amount (1 to 5 percent) of excess pumping to maintain an inward hydraulic gradient.

The Final FSSOB will be modified based on this DWQ response to public comments and will include estimates of injectate quantity. As the project continues the FSSOB will be modified to provide more accurate quantities of fluid injected into the Class III in situ copper recovery injection wells. These minor modifications will be made under 40 CFR Section 144.41.

DWQ Note- The Uranium Watch Comments did not include (3)

16. Comment

(4) A brief summary of the basis for the draft permit conditions including references to applicable statutory or regulatory provisions and appropriate supporting references to the administrative record required by §124.9 (for EPA-issued permits);

DWQ Response

The Permit is issued by the State of Utah, not the EPA, under UIC Primacy and UAC R317-7. A brief summary of the basis for the AE and Bond revisions including references to applicable statutory or regulatory provisions and appropriate supporting references to the administrative record required by UAC R317-7 was provided in the December 8, 2021 FSSOB. The AE decision is not part of Utah's UIC primacy and the AE request will be made to the EPA if the Director finds that it meets the criteria of in 40 CFR 144.7 and 40 CFR 146.4. The Responses will be incorporated into the exemption request record submitted to the EPA.

17. Comment

(5) Reasons why any requested variances or alternatives to required standards do or do not appear justified;

DWQ Response

There are no requested variance or alternatives to required UIC standards in the December 8, 2021 FSSOB.

18. Comment

(6) A description of the procedures for reaching a final decision on the draft permit including:

(i) The beginning and ending dates of the comment period under §124.10 and the address where comments will be received;

(ii) Procedures for requesting a hearing and the nature of that hearing; and

(iii) Any other procedures by which the public may participate in the final decision.

(7) Name and telephone number of a person to contact for additional information.

DWQ Response

(i) The beginning and ending dates of the comment period were not in the December 8, 2021 FSSOB. However, the published notice in the San Juan County Recorder as shown in the affidavit (DWQ-2021-032464) from the paper states the Public comment period was published on the December 8, 2021 and states the Public Comment will be received through February 8, 2021. The public notice is also posted on the website (DWQ-2021-030504) with the December and February 8th beginning and ending dates respectively.

(ii) Procedures for requesting a hearing were provided in the December 8, 2021 FSSOB.

(iii) The procedures by which the public may participate in the final decision were included in the December 8, 2021 FSSOB.

(7) Names and telephone numbers of persons to contact for additional information are provided in the December 8, 2021 FSSOB.

19. Comment

The October 2021 DWQ Fact Sheet does not meet these EPA requirements, just as the November 4, 2020, FSSOB for the Class III UIC Permit did not meet the federal requirements for a UIC Permit FSSOB. The EPA regulations do not state that a State Program can substitute other documents to full fill the FSSOB requirements.

DWQ Response

The comment misstates the applicable dates for the FSSOB's. Specifically, by the commenter's own admission- see Comment #5 above, the notices and postings contain an FSSOB for the initial comment period, dated November 4, 2020 and an FSSOB for the AE and Financial Assurance period as described in the Introduction on page 1 above, dated December 8, 2021.

With that clarification, the November 4, 2020 FSSOB is not part of the current Public Notice and Comment and no response is required of the DWQ per 40 CFR Section 124.5(c). Responses to comments on the December 8, 2021 DWQ Fact Sheet are provided above under Responses Section 2.2 and minor modifications to the Final FSSOB will be made per 40 CFR Section 144.41.

DWQ is satisfied that the FSSOB contains no substantive errors and meets the difficult and competing requirements "to briefly describe the principal facts and the significant factual, legal, methodological and policy questions considered in modification of the Permit."

20. Comment

2.3 December 2021 FSSOB and EPA Requirements

2.3.1. The FSSOB is supposed to provide a brief description of the type of facility or activity which is the subject of the draft permit. However, this information is missing.

2.3.2. A FSSOB should include a description of "the type and quantity of wastes, fluids, or pollutants which are proposed to be or are being treated, stored, disposed of, injected, emitted, or discharged." The 2021 FSSOB does not meet this requirement.

DWQ Response

Please see comment responses 14 through 19 above.

21. Comment

2.3.3. The FSSOB is supposed to contain a "brief summary of the basis for the draft permit conditions including references to applicable statutory or regulatory provisions and appropriate supporting references to the administrative record." The October 2021 FSSOB does not contain any information about the Aquifer Exemption, the Aquifer Exemption Request to the EPA (Permit Attachment M), or the Financial Assurance Estimate (Permit Attachment J), with supporting references to the administrative record. There is no discussion in the FSSOB of how, exactly, the proposed Aquifer Exemption meets the applicable technical criteria and standards.

DWQ Response

Please see comment response 19 above.

22. Comment

2.3.4. Attachment J to the October 2020 Draft Class III Area Permit, Underground Injection Control (UIC) Program, UIC Permit Number: UTU-37-AP-5D5F693, is the “Financial Responsibility. The Standby Trust Agreement along with Schedule A and the Associated Financial Guarantee Bond will be approved and delivered to the DEQ’s Office of Support Services prior to Director Authorization to Inject.” However, the Attachment J issued for public comment in December 2021 is not a Standby Trust Agreement or a Financial Guarantee Bond. It is only an Independent Financial Assurance Bonding Estimate. There is no reference to an Attachment J that would be a Standby Trust Agreement or a Financial Guarantee Bond, which would have legal force and effect.

DWQ Response

Please see comment responses 14 through 19 above.

23. Comment

Attachment M to the October 2020 Draft CLASS III Area Permit is supposed to be an Aquifer Exemption Request. However, as an attachment to the Permit, the DEQ Aquifer Exemption Request to be submitted to the EPA has no legal force an effect, so it is hard to understand why it would be part of the UIC Permit. Only an Aquifer Exemption, approved by the DWQ and the EPA Region 8, would have legal force and effect and be included in the Class III UIC Permit.

DWQ Response

The Permit and AE are related even if they are separate processes. Please see response to comment 35 below.

24. Comment

2.4. Duration of Permit

The FSSOB states: “Recommended Duration of Permit - December 31, 2026.” However, there is no information explaining the duration of the Permit. The whole proposed ISL operation will last for 20 years or more. According to the Clear Creek Associates, LLC, Third Party Closure Costs Review, Phase 1 of the ISL operation—the GTO deposit—will last 10 years.

DWQ Response

The Permit duration meets the requirements of R317-7-9.5 and 40 CFR 144.36 and Part III, Section A states: "This UIC Class III In-situ copper recovery permit shall be issued for five years unless terminated sooner according to Part II(D)(6)(b) of this permit. The Director of the Utah Division of Water Quality (hereafter referred to as 'the Director') shall review permit renewal requests submitted by the Lisbon Valley once every five (5) years to determine whether it should be modified, revoked and re-issued, terminated, or undergo minor modification according to the requirements of Part II (D)(6) of this permit." According to R317-7-9.5 and 40 CFR 144.36; Each issued Class III well permit shall be reviewed by the Director at least once every five years to determine whether it should be modified, revoked and reissued, or terminated. The Director may issue any permit for a duration that is less than the full allowable term under this section. The Director determined that the duration of the permit will correspond with the 5-year review period and renewal of the permit is contingent on the basis of the Director's review.

25. Comment

The process for the Permit renewal is not discussed in the FSSOB. Additionally, since the permits from the Bureau of Land Management (BLM) and Utah Division of Oil, Gas & Mining (DOGGM) that are necessary to commence the development of the ISL copper recovery operation have not been applied for and the required authorizations will probably not be approved before 2025, the Duration of the Permit is very short. This short Duration of Permit has not been explained.

DWQ Response

As stated in the first part of Response 2.3 (Comment 20), The Permit duration meets the requirements of R317-7-9.5 and 40 CFR 144.36. The Division does not have the authority to regulate beyond the governing UIC statute and regulations, including federal requirements such as National Environmental Policy Act (NEPA) permit status and compliance. These requirements fall under the authority of the Bureau of Land Management (BLM). A NEPA decision, including a record of decision from the BLM, is not required prior to issuance of the UIC Class III Area Permit for in situ copper recovery. In addition, The Division does not have the authority to regulate surface operations regulated by the Utah Division of Oil, Gas and Mining (DOGGM). A mining permit from DOGM is not required prior to issuance of the UIC Class III Area Permit for in situ copper recovery. Surface reclamation is covered by DOGM requirements, not the UIC Program, statute, or regulations.

No permit or AE Request changes are necessary based on DWQ's response but the Final FSSOB will be modified to include the basis for the Permit duration.

26. Comment

3. Independent Financial Assurance Bonding Estimate — Permit Attachment J

3.1 The new Attachment J to the Permit is an August 20, 2021, “Independent Financial Assurance Bonding Estimate,” developed by Clear Creek Associates, LLC (Clear Creek). This document is confusing. Attachment J is supposed to be part of the UIC Permit, but the DWQ does not provide any basis for incorporating the 2021 “Independent Financial Assurance Bonding Estimate” into the UIC Permit. Rather, the Bonding Estimate appears to be part of the LVMC Application.

The FSSOB does not contain any evaluation of the Bonding Estimate or a statement regarding whether or not the DWQ accepts this estimate as the basis for the bonding of the project. So, the meaning of the Bonding Estimate is unclear.

DWQ Response

As stated in the FSSOB open for this public notice DWQ’s review of the public comments on the Permit and the original FSSOB and associated documents in the permit record, DWQ has determined that more detail and specification are needed with respect to the proposed financial assurance mechanism (Permit Attachment J). Specifically, the Division requested that the operator obtain and provide a third-party financial assurance estimate. The estimate resulted in an increased financial assurance amount, from 4.5 to 6.2 million dollars U.S., which DWQ reviewed and accepted and published with the current public notice as it compensates for previous lack of bonding for long term, 20 years, post in situ copper recovery closure monitoring, total bond amount upward adjustment for escalation based on DOGM rates, and wellfield rinsing with bicarbonate solution. These elements were published with the third-party bond estimate and explained during the public hearing held on January 19th, 2022.

No permit or AE Request changes are necessary based on DWQ’s response but the Final FSSOB will be modified to include the basis for the increased financial assurance estimate by Clear Creek and Associates.

27. Comment

3.2 According to the October 2020 Draft Permit, “The Standby Trust Agreement along with Schedule A and the Associated Financial Guarantee Bond will be approved and delivered to the DEQ’s Office of Support Services prior to Director Authorization to Inject.” However the DWQ has not provided any evaluation of the LVMC’s bonding estimates.

DWQ Response

Refer to the response above for Comment 26. No permit or AE Request changes are necessary based on DWQ's response but the Final FSSOB will be modified to include the basis for the increased financial assurance estimate by Clear Creek and Associates.

28. Comment

3.3 The October 2020 Lisbon Valley Mining Company LLC, Lower Lisbon Valley ISR Technical Report, Attachment J, starting at the page after page 166 to page 168, includes a discussion of Financial Responsibility. The Technical Report states that the LVMC's preliminarily estimates its ISL-specific bonding requirement to be approximately \$4.5 million for the first three years" of the ISL Copper Recovery Project. The 2021 Independent Financial Assurance Bonding Estimate is \$6,183,349—a substantial difference. The FSSOB does not evaluate the new bonding estimate or indicate how much the Division will require as a bonding requirement for the ISL-specific aspects of the Project. If the DWQ does not provide an analysis of the bonding estimates or state how much the financial assurance will be required by the DWQ, there is really no basis for public comments on the Bonding Estimate.

DWQ Response

Refer to the response above for Comment #26. No permit or AE Request changes are necessary based on DWQ's response but the Final FSSOB will be modified to include the basis for the increased financial assurance estimate by Clear Creek and Associates.

29. Comment

3.4 Project Timetable

The Independent Financial Assurance Bonding Estimate includes a description of the Project Timetable for Phase I of the ISL Project—the GTO deposit (page 5). There is another Project Timetable, which is included in the DWQ Aquifer Exemption Request as Figure 8 (page 27). Figure 8. Lisbon Valley Mining Company's timetable for project development is produced from Figure 11.9 of the Lisbon Valley Mining Company Technical Report (LVMC, 2020; 141). The Project Timetable in the DWQ Aquifer Exemption Request is significantly different from the timetable used by Clear Creek to develop there Bonding Estimate. See Table 1, below.

DWQ Response

Table 1 from the original comment submittal is not reproduced in this response as it can be viewed in Attachment A. Clear Creek based their table on updated projections for monitoring and bicarbonate rinsing so the Draft project timetable is different. The timetable is an estimate

of how the project will progress but there may be unexpected delays or changes depending upon required elements like the Aquifer Exemption (see Permit Part I).

30. Comment

Neither timetable takes into consideration the length of time to obtain the necessary authorizations from the BLM, DOGM, Utah Division of Air Quality, and possibly the Utah Division of Waste Management and Radiation Control. If the LVMC intends to dispose of liquid wastes via deep well injection, that, too, will require another UIC Permit. Those permitting processes will take 2 years or more. The Bonding Estimate is only for the first 3 years of the ISL Project. Therefore, the timetable that is the basis for the Bonding Estimate is incomplete, conflicting, and does not take into consideration the full extent of Phase I of the ISL Project.

DWQ Response

DWQs response to 2.3 (Comment #20) above addresses this comment. The timetable is an estimate and modifications will be made to the Permit either at the year of renewal or during the Permit duration under 40 CFR Section 144.41 to reflect minor modifications to the project schedule if necessary.

31. Comment

TABLE I - PROJECT TIMETABLE — GTO DEPOSIT				
Financial Assurance Bonding Estimate			DWQ Aquifer Exemption Request	
Year		Activity	Year	Activity
1st	2022	Construction	1st	Permitting & Licensing
2nd	2023	Leaching	2nd	5-Spot Test, Exploration/ Development Drilling, Copper

				<i>Production, & Wellfield Stability Monitoring</i>
<i>3rd</i>	<i>2024</i>	<i>Leaching</i>	<i>3rd</i>	<i>Injection Wellfield Construction, Production Wellfield Construction, Copper Production. & Wellfield Stability Monitoring</i>

TABLE I - PROJECT TIMETABLE — GTO DEPOSIT				
Financial Assurance Bonding Estimate			DWQ Aquifer Exemption Request	
Year	Activity		Year	Activity
<i>4th</i>	<i>2025</i>	<i>Wellfield Restoration Rinsing</i>	<i>4th</i>	<i>Injection Wellfield Construction, Production Wellfield Construction, Copper Production, & Wellfield Stability Monitoring</i>

5th	2026	Wellfield Restoration Rinsing	5th	Injection Wellfield Construction, Production Wellfield Construction, Copper Production, & & Wellfield Stability Monitoring
6th	2027	Wellfield Abandonment	6th	Injection Wellfield Construction & Production Wellfield Construction, Copper Production, Wellfield Stability Monitoring, Regulatory Approval of Restoration, Wellfield Restoration Rinsing
7th	2028		7th	Injection Wellfield Construction & Production Wellfield Construction, & Copper Production, Wellfield Stability Monitoring, Wellfield Restoration Rinsing, Regulatory

				<i>Approval of Restoration, Wellfield Plugging & Abandonment, & Wellfield Decommissioning</i>
<i>8th</i>	<i>2029</i>		<i>8th</i>	<i>Injection Wellfield Construction & Production Wellfield Construction, Copper Production, Wellfield Stability Monitoring, Wellfield Restoration Rinsing, Regulatory Approval of Restoration, Wellfield Plugging & Abandonment, & Wellfield Decommissioning</i>
<i>9th</i>	<i>2030</i>		<i>9th</i>	<i>Injection Wellfield Construction & Production Wellfield Construction, & Copper Production, Wellfield Stability</i>

				<p><i>Monitoring, Wellfield Restoration Rinsing, Regulatory Approval of Restoration, Wellfield Plugging & Abandonment, & Wellfield Decommissioning</i></p>
--	--	--	--	--

TABLE I - PROJECT TIMETABLE — GTO DEPOSIT				
Financial Assurance Bonding Estimate			DWQ Aquifer Exemption Request	
Year		Activity	Year	Activity
10th	2031	<p><i>Monitoring Well Abandonment</i></p>	10th	<p><i>Injection Wellfield Construction & Production Wellfield Construction, Copper Production, Wellfield Stability Monitoring, Wellfield Restoration Rinsing, Regulatory Approval of Restoration, Wellfield</i></p>

				<i>Plugging & Abandonment, & Wellfield Decommissioning</i>
<i>11th</i>			<i>11th</i>	<i>Copper Production, Wellfield Stability Monitoring, Wellfield Restoration Rinsing, Regulatory Approval of Restoration, Wellfield Plugging & Abandonment, & Wellfield Decommissioning</i>
<i>12th</i>			<i>12th</i>	<i>Copper Production, Wellfield Stability Monitoring, Wellfield Restoration Rinsing, Regulatory Approval of Restoration, & Wellfield Decommissioning</i>

<p>13th</p>			<p>13th</p>	<p>Copper Production, Wellfield Stability Monitoring, Wellfield Restoration Rinsing, Regulatory Approval of Restoration, Wellfield Plugging & Abandonment, & Wellfield Decommissioning</p>
<p>14th</p>			<p>14th</p>	<p>Copper Production, Wellfield Stability Monitoring, Wellfield Restoration Rinsing, Regulatory Approval of Restoration, Wellfield Plugging & Abandonment, & Wellfield Decommissioning</p>

			<p>To Year 25</p>	<p>Unknown Period of Wellfield Stability Monitoring, Wellfield Restoration Rinsing, Regulatory Approval of Restoration, Wellfield Plugging & Abandonment, & Wellfield Decommissioning</p>
--	--	--	---------------------------	---

3.5 There is no basis for DWQ acceptance of the “Independent Financial Assurance Bonding Estimate,” because:

- a. There are conflicting operational timetables in the Independent Financial Assurance Bonding Estimate and the Underground Injection Control Program Aquifer Exemption Request.
- b. The DWQ did not provide an analysis of the Independent Financial Assurance Bonding Estimate or state the amount of financial assurance acceptable to the DWQ.
- c. The Independent Financial Assurance Bonding Estimate Project Timetable is unrealistic because it does not consider the time required for the BLM, DOGM, and other permit and licensing application and review processes necessary for commencement of the ISL project.

DWQ Response

DWQs response to Comments 3.1 and 3.4 (Comments #26 and 27) above addresses these comments.

No permit or AE Request changes are necessary based on DWQ’s response but the Final FSOB will be modified to include the basis for the increased financial assurance estimate by Clear Creek and Associates.

32. Comment

3.6 The Financial Assurance Bond should be reviewed at least once a year and after any significant change in the Project that would affect the reclamation costs.

DWQ Response

Per DWQ response to Comment #20 the Permit and Financial Assurance Bond will be reviewed every 5 years and escalation is applied for the 5 year out period to conservatively cover any changes in plugging and abandonment, wellfield closure costs and groundwater restoration.

33. Comment

*3.7 The DWQ, in responding to public comments on the LVMC Class III UIC Permit stated: "Following in situ copper recovery, groundwater will be restored in the BC Aquifer until water quality parameters have reached levels **that are technically and economically feasible** to achieve per Part III.G and Attachment H of the Draft Permit(DWQ 2020a)." ² It is apparent from this statement that any Financial Assurance Bond might not be sufficient to assure groundwater restoration in the exempted aquifer and in nearby non-exempted aquifer.*

DWQ Response

Per DWQ response to Comment #26, DWQ has assessed the adequacy of the estimated bond amount and has determined that it is sufficient.

34. Comment

*3.8 The DWQ, in responding to public comments on the LVMC Class III UIC Permit stated: "Following in situ copper recovery, groundwater will be restored in the BC Aquifer until water quality parameters have reached levels **that are technically and economically feasible** to achieve per Part III.G and Attachment H of the Draft Permit(DWQ 2020a)." ³ It is apparent from this*

² Lisbon Valley Mining Company LLC, Underground Injection Control (UIC) Class III Draft Area Permit No. UTU-37-AP-5D5F693. Utah Department of Environmental Quality, Division of Water Quality Public Comments and Responses, Public Hearing and Comment Period from: October 31, 2020, to January 11, 2021. Comment 4.13: Division Response, page 26.

³ Lisbon Valley Mining Company LLC, Underground Injection Control (UIC) Class III Draft Area Permit No. UTU-37-AP-5D5F693. Utah Department of Environmental Quality, Division of Water Quality Public Comments and Responses, Public Hearing and Comment Period from: October 31, 2020, to January 11, 2021. Comment 4.13: Division Response, page 26.

statement that any Financial Assurance Bond might not be sufficient to assure groundwater restoration in the exempted aquifer and in nearby non-exempted aquifer.

DWQ Response

Per DWQ response to Comment #26, DWQ has assessed the adequacy of the estimated bond amount and has determined that it is sufficient.

35. Comment

4. Underground Injection Control Program Aquifer Exemption Request — Permit Attachment M.

4.1 Attachment M to the Class III UIC Permit is the draft State of Utah Underground Injection Control Program Aquifer Exemption Request Submitted to the EPA Region 8.

The December 8, 2021, FSSOB for the draft Underground Injection Control (UIC) Class III Area Permit (Permit) for LVMC, references the Class III Area Permit and the proposed Aquifer Exemption Request (Permit Attachment M). However, it seems that the UIC Permit should include the Final Aquifer Exemption, not the DWQ Aquifer Exemption Request submitted to the EPA Region 8, Underground Injection Control Program, or the Original 2020 LVMC Aquifer Exemption Request. Attachment M to the original 2020 Draft UIC Permit is the LVMC Aquifer Exemption Request. The DWQ has not indicated that the Aquifer Exemption Request to EPA Region 8 replaces that document or supplements the LVMC Aquifer Exemption Request. However, neither document is a draft Aquifer Exemption that would become part of the final Class III UIC Permit.

DWQ Response

An Aquifer Exemption sought from EPA is a separate process from the Class III UIC Permit. As set forth in the LVMC Class III UIC draft Permit Part 3. E.1, the Permit is only effective if the Aquifer Exemption requirement is met. There is no requirement to obtain an Exemption before obtaining a permit.

36. Comment

5. Aquifer Exemption Request

The DWQ requests comments on State of Utah Underground Injection Control Program Aquifer Exemption Request Submitted to the U.S. Environmental Protection Agency Region 8, December 1, 2021.

5.1 Aquifer Exemption Request to be submitted to the EPA Region 8 is Incomplete and Misleading.

5.1.1 The DWQ Aquifer Exemption Request should contain maps of the proposed wellfields in each ISL deposits: Lone Wolf, GTO, and Flying Diamond. Instead, there is a very rough map with only a few wells indicated (Figure 2, page 6) and a diagram of typical wellfield configuration (Figure 3, page 7). This does not provide the EPA, or the public, with complete and accurate information on the placement of the wells associated with the ISL operation.

DWQ Response

From the AE request Basis for Decision Section, Regulation 40 CFR § 144.7(c)(1) requires a UIC Class III Permit Application that “necessitates an aquifer exemption under 40 CFR §146.4(b)(1) to furnish the data necessary to demonstrate that the aquifer is expected to be mineral or hydrocarbon producing. Information contained in the mining plan for the proposed project, such as a map and general description of the mining zone, general information on the mineralogy and geochemistry of the mining zone, analysis of the amenability of the mining zone to the proposed mining method, and a timetable of planned development of the mining zone” shall be considered by the UIC Director. 40 CFR 144.7(c)(1) requires general information on the mining zone and mining methods but does not require maps of proposed wellfields for each deposit.

37. Comment

5.1.2 The Aquifer Exemption Request to the EPA states (page 8):

The predominant land uses within the Project Area are mining and ranching. Most of the land surface serves as grazing land for cattle. Some of the land is used for recreational activities—primarily off-road motorsports and hunting. However, ISR is compatible with multiple land uses, and operations can be conducted with little impact on existing activities.

*The DWQ provides no basis for its assumption that the ISL copper recovery operations “can be conducted with little impact on existing activities.” This proposed ISL Project is a major industrial project with significant surface and subsurface impacts. The DWQ fails to describe the impacts to the area and various “multiple” uses from the project and describe how and why the ISL operations will have little impact, or impacts will be mitigated. The DWQ has not developed an environmental analysis of the proposed project. Such analyses will be developed by the Bureau of Land Management and Utah Division of Oil, Gas & Mining **after** LVMC submits applications to those agencies for authorization to conduct the ISL operation.*

DWQ Response

DWQ agrees that an assessment of impacts should be conducted by the BLM and DOGM as part of their surface mining permit process. This statement from the AE request has been modified.

38. Comment

5.1.3 The ISL operations will, in fact, have an adverse impact on existing activities. The DWQ received numerous comments on the Class III UIC Permit for the project that document and discuss numerous adverse impacts to nearby residents and their livelihoods.⁴ Such impacts include:

- a. Reduction of available water due to depletion of aquifer*
- b. Dust*
- c. Industrial noise from drilling, truck traffic, and other activities*
- d. Degradation of the landscape*
- e. Radon and other radioactive emissions that will not be monitored or mitigated*
- f. Disturbances to domestic livestock*
- g. Disturbances to wildlife*
- h. Destruction of the view shed in a prime recreational area*
- i. Negative impacts on customers and potential customers of nearby year-round recreational business*
- j. Negative impacts to adjacent cattle operation*
- k. Adverse impacts to the economic, social, and individual and community health and wellbeing*
- l. Destruction of historic community livelihoods*
- m. Loss of grazing resources*
- n. Loss of property values*
- o. High potential for contamination of vulnerable and limited domestic water supply of local residents and businesses*

DWQ Response

The DWQ response to this comment is the same as for Comment 37.

39. Comment

5.1.4 The DWQ Aquifer Exemption Request ignores impacts related to radioactivity in the soils and rock, air, and water in the Project area. The Aquifer Exemption Request states, in regards to radiological contaminants (page 16):

The concentrations of other contaminants, including uranium and radioactivity, in some groundwater samples exceeded maximum contaminant levels (MCLs).

⁴ https://uraniumwatch.org/LVMC_DWQ_UICPermit/DWQ_PublicComments_LVMC_UICPermit_2020-2021.pdf

Some BC Aquifer groundwater has high radium and gross alpha and uranium concentrations above MC

The concentrations of other contaminants, including uranium and radioactivity, in some groundwater samples exceeded MCLs.

The Lisbon Valley and surrounding area were a major uranium mining area, providing uranium for the U.S. atomic weapons program and commercial nuclear reactors. The DWQ Aquifer Exemption Request references two publications that identify the Lisbon Valley as Utah's Largest Uranium District.⁵ There are numerous abandoned, reclaimed, and partially reclaimed uranium mines in the area.⁶ There are 4 permitted, or partially permitted, uranium mines in the area (La Sal Mines Complex, Energy Queen, Rim, and Sage Mines), and a closed and partially reclaimed uranium mill (Lisbon Valley Mill).

The road building, drilling, and other surface disturbances will mobilize radioactive particulates and increase radon emissions. In addition to mobilizing copper in the Burro Canyon Aquifer, the dilute sulfuric acid lixiviant will also mobilize uranium. The uranium and other radionuclides will be concentrated in the copper recovery process such that the concentrated materials (solids or liquids) may require a source material license issued by the Utah Division of Waste Management and Radiation Control. There was no mention of this in the UIC Permit Application.

The mobilized uranium, and other contaminants, will also remain in the aquifer and are likely to spread to surrounding areas outside the wellfields. The flushing process can concentrate uranium in evaporation ponds. Also, ISL wellfields are subject to excursions, spills, pipe leaks, and other accidents. There is abundant evidence that ISL uranium recovery operations have never been able to restore wellfield aquifers to pre-mining conditions. Further discussion of the hazards and historic impacts of ISL uranium recovery operations in Section 5.1.7 and Section 6, below.

DWQ Response

The Permit authorizes the injection of leach solution for copper recovery and uranium and other constituents will be mobilized in concentrations that will be similar to current leach solutions used for copper solution mining by heap leach operations. Permit conditions for the detection, control, and mitigation of groundwater impacts are not part of the current public notice and the surface impacts of mining and related permitting and regulatory decisions are the jurisdiction of UPDES, BLM and DOGM. The original and new Financial Assurance amount open for public notice and comment includes bicarbonate addition to post ISR rinse solutions for

⁵ https://archives.datapages.com/data/uga/data/078/078001/534_ugs780534.htm

⁶ <https://www.energy.gov/lm/defense-related-uranium-mines-report-congress>

groundwater restoration and bond estimate contingencies for unexpected costs related to groundwater restoration. The residual process solution chemistry and matrix effects for copper in situ recovery will be different than that for in situ uranium recovery operations and groundwater restoration can be achieved using enhanced neutralization with bicarbonate addition to groundwater rinse solutions. The Utah Division of Waste Management and Radiation control may have purview on some mining process wastes at the surface but uranium-bearing in situ leach solutions are not regulated as hazardous substances otherwise in situ uranium or copper recovery operations, like those cited in comment 5.1.4 would not be permitted and operating. Moreover, surface mining facility regulations are not part of the current Public Notice and Comment on the AE and Financial Assurance estimate. The US EPA website:

[https://www.epa.gov/radiation/technologically-enhanced-naturally-occurring-radioactive-materials-tenorm#:~:text=Technologically%20Enhanced%20Naturally%20Occurring%20Radioactive%20Material%20\(TENORM\)%20is%20defined%20as,extraction%2C%20or%20water%20processing.%E2%80%9D](https://www.epa.gov/radiation/technologically-enhanced-naturally-occurring-radioactive-materials-tenorm#:~:text=Technologically%20Enhanced%20Naturally%20Occurring%20Radioactive%20Material%20(TENORM)%20is%20defined%20as,extraction%2C%20or%20water%20processing.%E2%80%9D)

and references therein describes its position on regulation of Technologically Enhanced Naturally Occurring Radioactive Material (TENORM) but the agency has not developed UIC or other rules restricting concentrations in solution mining operations and other industrial processes that The State of Utah follows the EPA state primacy regulatory standards and has not developed any UIC regulations or standards or restrictions for TENORM in solution mining processes. Furthermore, there are no specific regulations on TENORM that factor into an AE decision.

40. Comment

5.1.5 Incomplete Identification of Area Municipal Water Supplies

The discussion of Private and Public Wells Outside the Permit Area / Aquifer Exemption Boundary (page 21) discusses possible impacts to water for the City of Monticello and the towns of La Sal, Utah, and Egnar, Colorado. However, there is no mention of potential impacts to the municipal well and aquifer that supplies water to the community of Eastland, Utah, 20 to 30 miles south Lisbon Valley.

DWQ Response

Given the distance and general flow direction of groundwater the potential impacts to groundwater in Eastland Special Services District are similarly small as for Monticello.

41. Comment

5.1.6 Incomplete Data and Information.

A major concern in the proposed ISL project is the migration of injected lixiviant and mobilized copper, uranium, and other minerals outside the Exempted Aquifer and ore zones into nearby Underground Sources of Drinking Water (USDWs). According to the DWQ Aquifer Exemption Request (page 28), "A number of factors, including Class III Area Permit requirements, led the Director to the conclusion that adjacent USDWs will not be impacted by ISR contaminants crossing the AE boundary laterally or migrating vertically." However, that DWQ determination relies on future actions, testing, and verifications to support its assertions. The DWQ's assumptions that adjacent USDWs will not be impacted by ISL contaminants to adjacent USDWs cannot be verified at this time.

The DWQ lists the following actions required by the UIC Permit:

- a. Injection interval confining zones will be evaluated during pre-ISR operation wellfield pump tests for their capacity to contain injection interval fluid vertically within the approved injection interval per Permit conditions in Part III, Section E, and cited attachments (DWQ, 2020).*
- b. LVMC must demonstrate the ability of the confining zones to contain injection interval fluids before the Director will issue an authorization to commence injection per Permit conditions in Part III, Section E, and cited attachments (DWQ, 2020).*
- c. LVMC must demonstrate the ability of the monitoring network to detect any movement of injection interval fluids out of the approved injection interval before the Director will issue an authorization to commence injection per Permit conditions in Part III, Section G, and cited attachments (DWQ, 2020).*
- d. The requirements to demonstrate initial mechanical integrity for all injection, production, and monitoring wells and ongoing mechanical integrity tests for injection wells will prevent vertical migration of injection interval fluids through confining zones per Permit conditions in Part III, Sections G and I, and cited attachments (DWQ, 2020).*
- e. Part III, Sections E, G, and J (and cited attachments), of the Permit requires LVMC to develop a groundwater restoration plan for each wellfield that includes monitoring to evaluate the long-term stability of restored ISR contaminant concentrations to ensure that no ISR contaminants cross the AE boundary (DWQ, 2020).*

Additionally, the DWQ assumes that:

The extensive monitoring well network will verify both lateral and vertical containment of injection interval fluids. If any injection interval fluids begin to migrate out of the approved injection interval, the water level measurements in the monitoring well network will provide early detection to allow LVMC to implement timely corrective response actions to reverse the migration per Permit conditions in Part III, Sections C, G, and H, and cited attachments (DWQ, 2020).

These are actions, demonstrations, and monitoring will occur after the Aquifer Exemption has been approved, not before. The DWQ and EPA should not base their approval of an Aquifer Exemption on significant data and information that is not available at the time of the Aquifer Exemption Review.

At this time the DWQ does not have the data and information necessary for the DWQ and EPA to determine:

- a. Whether the injection interval confining zones have the capacity to contain injection interval fluid vertically within the approved injection interval;*
- b. Whether the confining zones will be able to contain injection interval fluids;*
- c. The ability of the monitoring network to detect any movement of injection interval fluids out of the approved injection interval;*
- d. Whether the LVMC will be able to demonstrate initial mechanical integrity for all injection, production, and monitoring wells and ongoing mechanical integrity tests for injection wells will prevent vertical migration of injection interval fluids through confining zones;*
- e. Whether there is an adequate groundwater restoration plan for each wellfield;*
- f. Whether any injection interval fluids will to migrate out of the approved injection interval;*
- g. Whether the wellfield aquifer and adjacent aquifers can be returned to pre-mining baseline conditions; and*
- h. Whether the nearby Underground Sources of Drinking Water will be contaminated by the ISL operation.*

Therefore, the DWQ and EPA do not have the necessary data and information to support an Aquifer Exemption.

DWQ Response

DWQ has provided all of this information in the AE Request for EPA consideration and decision. However, DWQ has determined that the criteria for the AE has been met under Regulations in 40 CFR § 146.4(a) and 40 CFR § 146.4(b)(1).

42. Comment

The ISL uranium recovery industry and the Nuclear Regulatory Commission (NRC), which has regulated many of ISL uranium recovery operations over several decades, has long recognized that the uncontrolled movement of lixiviant beyond the ore zone—called an excursion—is an ongoing and significant problem. In 1986, NRC issued a report, “An Analysis of Excursions at Selected In Situ Uranium Mines in Wyoming and Texas.”⁷ Commenters incorporate this study into these comments, by reference. This 1986 report summarized the history of excursions at selected in situ mines in the United States and discussed methodologies for excursion identification and control. The study found that “vertical excursions of lixiviant migrating into an overlying aquifer through poorly plugged exploration holes continue to plague the industry.” The study also framed the problems and purpose of the study:

One of the major problems associated with the in situ mining method is the uncontrolled migration of lixiviant and dissolved constituents such as radionuclides, arsenic, selenium, chromium and lead outside of the production zone. These undesirable lixiviant migrations are known as excursions. Horizontal and/or vertical excursions have occurred at many of the in situ uranium mine sites in the western United States, and are recognized by mining companies as events that should be prevented.

Excursions are a result of both natural and man-made causes. However, the absence of critical data often prevents the complete understanding of the causes. In these cases, excursion clean-up can be very expensive and sometimes impossible. The development of a sound data base on the hydraulic properties of the aquifer and confining layers, hydrogeologic characteristics of faults, and the condition of abandoned drill holes prior to mining is essential to excursion prevention and control. This study is being conducted to obtain a better understanding of the hydrogeologic factors that control excursions and to develop proper methods of hydro-geologic evaluation of uranium in situ mine sites located in the United States. (Page 1.)

⁷ “An Analysis of Excursions at Selected In Situ Uranium Mines In Wyoming and Texas;” NUREG/CR-3967 ORNL/TM-9956. Prepared by W. P. Staub, et al., Oak Ridge National Lab. Division of Waste Management, Office of Nuclear Material Safety and Safeguards, U.S.Nuclear Regulatory Commission; July 1986.
<https://www.nrc.gov/docs/ML1422/ML14224A351.pdf>

PURPOSE AND OBJECTIVES

The purpose of this study is to obtain a better understanding of excursions at in situ uranium mines. The general objectives are to evaluate the hydrogeologic factors that control excursions, to develop hydro-geologic evaluation guidelines that should be followed in order to achieve a thorough understanding of the hydrogeologic characteristics at potential or existing in situ uranium mine sites. Proper understanding of the hydrogeology prior to mining a given area is essential to prevent excursions from the production zone during mining. (Page 2.)

A discussed above, at this time the LVMC and the DWQ do not have the information, data, and analyses necessary to fully evaluate the impacts of the proposed ISL project in, and adjacent to, the exempted aquifer. The LVMC and DWQ have not gained a proper understanding of the hydrogeology prior to mining a given area, which is essential to prevent excursions from the production zone during mining.

DWQ Response

The Permit states conditions that will ensure that excursions do not occur and if leach solutions encroach upon control boundaries the required monitoring and contingency actions will detect them and mitigate them. However only the Financial Assurance condition is part of this public notice and comment. The AE Request only refers to these conditions in the context of the need for the AE and the basis for the portion of the BC Aquifer that is being exempted because of the occurrence of copper mineralization that is amenable to in situ copper recovery. The basis of the AE does not require analysis of all potential excursions, only the proximity of USDWs and sources of drinking water.

43. Comment

5.1.8 Handling of Wastes

The DWQ does not discuss the liquid and solid waste streams from the ISL operation, the volume and constituents of those wastes, and how they will be managed during mine operation, and the ultimate disposition of those waste streams. The waste streams from the proposed ISL operation will contain radionuclides. There is no evaluation of possible surface contamination by radionuclides and other minerals and how those contaminants will impact wild and domestic animals and the native and domesticated plants and animals they feed on.

DWQ Response

DWQs' response to comment 39 addresses this comment.

44. Comment

5.1.9 The Aquifer Exemption boundary has been arbitrarily redrawn to satisfy regulatory criteria. LVMC has modified spatial aquifer exemption boundaries by effectively redrawing lines on paper to avoid private wells, without regard to aquifer geology and without adequate changes to operational parameters to actually prevent contamination of the water supplies. LVMC and the DWQ ignore basic hydrogeology and contaminant transport mechanisms.

DWQ Response

The portion of the BC aquifer that is defined in the AE request was determined on the basis of meeting the criteria of UIC regulations in 40 CFR § 146.4(a) and 40 CFR § 146.4(b)(1). These criteria do not include the proof of hydrogeologic controls and knowledge of contaminant transport mechanisms. These parameters and data have been considered in the writing of Permit conditions for protection of USDWs that are not part of this public notice and comment.

45. Comment

5.2 DWQ Oversight of Lower Lisbon Valley ISL Project

The LVMC has no experience operating a ISL copper recovery project. In addition, the DWQ has no experience regulating such a large and complex ISL operation. The lack of experience by both the LVMC and the DWQ is of great concern.

The LVMC will be required to submit monitoring data, wellfield installation information and data, notices related to unforeseen events, reclamation plans, and other information to the DWQ. This information will be important to nearby residents and other state and federal agencies that permit the mining operation. However, the DWQ does not an electronic reading room that will make sure these monitoring reports, data, inspection reports, notices of violation, and other information relevant to the operation of the wellfields are made readily available to the public in a timely manner. In addition, the DWQ does not require an interim management plan that commits the LVMC to certain protective actions if the ISL operation goes on standby.

The DWQ must require an interim management plan and assure that relevant documents pertinent to the ISL copper recovery operation are readily available to the public in a timely manner.

DWQ Response

UIC Class III solution mining regulations do not require a proponent to demonstrate experience with such projects but only to submit a viable plan to do so with the permit application per 40 CFR §146.4(b)(1). DWQ and predecessor agencies have regulated in situ solution mining operations in Grant and San Juan Counties since Utah was granted UIC primacy in the early 1980s. Current DWQ staff has several decades of combined experience with permitting and regulating ISL operations. Monitoring data must be submitted by LVMC on a quarterly basis and all of that information is available electronically by GRAMA request. The Permit requires the development of a contingency and corrective action plan if endangering non-compliance is reported, however this part of the Permit is not part of this public notice and comment.

46. Comment

6. Impacts from ISL Mineral Recovery Operations

There is abundant evidence of surface and underground contamination, some of which is irreversible, resulting from ISL uranium recovery operations. Uranium is the most common element removed from underground by ISL operations.

Sources of Aquifer Contamination⁸

6.1.1. While in situ leaching technology has certain advantages, it has significant disadvantages:

- a. The risk of spreading of leaching liquid outside of the uranium deposit, involving subsequent groundwater contamination,*
- b. The unpredictable impact of the leaching liquid on the rock of the deposit, and*
- c. The impossibility of restoring natural groundwater conditions after completion of the leaching operations.*

There are a number of possible Failure Modes:

- a. Injection well failure*
- b. Pipe failure*
- c. Spill after pipe failure*
- d. Evaporation pond liner failure*
- e. Spill of leaching fluids*
- f. Spread of leaching liquids outside the leaching zone*
- g. Mobilization of uranium and other contaminants*
- h. Aquifer restoration failures*

⁸ <https://www.wise-uranium.org/uisl.html>

Even with treatment schemes, various problems remain unresolved:

- a. Contaminants, which are mobile under chemically reducing conditions, such as radium, cannot be controlled,*
- b. If the chemically reducing conditions are later disturbed for any reasons, the the precipitated contaminants are re-mobilized,*
- c. If precipitated contaminants are re-mobilized, the restoration process takes very long periods of time, and*
- d. Not all parameters can be lowered appropriately.*

Most restoration experiments reported refer to the alkaline leaching scheme, since this scheme is the only one used in Western world commercial in-situ operations. Therefore, nearly no experience exists with groundwater restoration after acid in- situ leaching, the scheme that was applied in most instances in Eastern Europe. The only Western in-situ leaching site restored after sulfuric acid leaching so far, is the small pilot scale facility Nine Mile Lake near Casper, Wyoming (USA). The results can therefore not simply be transferred to production scale facilities. The restoration scheme applied included the first two steps mentioned above.⁹ It turned out that a water volume of more than 20 times the pore volume of the leaching zone had to be pumped, and still several parameters did not reach background levels. Moreover, the restoration required about the

The best results have been obtained with the following treatment scheme, consisting of a series of different steps [Schmidt1989], [Catchpole1995]:

Phase 1: Pumping of contaminated water: the injection of the leaching solution is stopped and the contaminated liquid is pumped from the leaching zone. Subsequently, clean groundwater flows in from outside of the leaching zone. Phase 2: as 1, but with treatment of the pumped liquid (by reverse osmosis) and reinjection into the former leaching zone. This scheme results in circulation of the liquid.

<https://www.wise-uranium.org/uisl.html>

same time as used for the leaching period [Nigbor1982] [Engelmann1982].¹⁰

6.1.2. The March 2012 study,¹¹ “Environmental Damage and Public Health Risks From Uranium Mining in the American West: Nuclear Fuel’s Dirty Beginnings” provides extensive data and information regarding ISL impacts. This report is incorporated into these comments, by reference. The study discusses some important aspects of ISL mineral recovery operations and documents the ways that:

- a. In-Situ Leach Mining Alters Groundwater Chemistry*
- b. In-Situ Leach Mining Causes Repeated “Spills, Leaks, and Excursions” of Contaminants*
- c. In-Situ Leach Mining Uses Scarce Groundwater*

- d. *In-Situ Leach Mining Creates Waste*
- e. *In-Situ Leach Mining Contaminates Aquifers*

6.1.3. *There is additional information documenting operational failures at NRC-licensed ISL uranium recovery operations included as Exhibit A. Exhibit B contains excerpts from the March 2016 "Citizen Petition to Repeal or Amend the EPA's Aquifer Exemption Regulations to Protect Underground Sources of Drinking Water."*¹²

DWQ Response

DWQs response to comment 39 responds to all points in comment 46 (6.1.) The Permit conditions provide for the detection, control and cleanup of groundwater contamination resulting from ISR if necessary but are not part of this public notice and comment. The AE Request provides the basis for the AE and not a reiteration of the Permit.

47. Comment

6.2. Wellfield Restoration

6.2.1. *A major challenge for any ISL mineral recovery operation is wellfield restoration. ISL mining of an aquifer changes the chemistry of the groundwater, with dramatic increases in the concentrations of copper, uranium, other naturally occurring radioactive elements and heavy metals. The DWQ and the LVMC do not have the information necessary to assure the restoration of the wellfield or that nearby aquifers and a domestic water supply will not be contaminated during the wellfield operation and subsequent to that operation. There is no information that would support a finding that any offsite contamination can be rectified. It would not take much to destroy the water quality of the*

<https://www.wise-uranium.org/uisl.html>

"Environmental Damage and Public Health Risks From Uranium Mining in the American West: Nuclear Fuel's Dirty Beginnings," Geoffrey H. Fettus and Matthew G. McKinzie; Natural Resources Defense Council,

<https://www.nrdc.org/sites/default/files/uranium-mining-report.pdf>

"Citizen Petition to Repeal or Amend the EPA's Aquifer Exemption Regulations to Protect Underground Sources of Drinking Water." Natural Resources Defense Council, et al., March 23, 2016. https://www.epa.gov/sites/default/files/2016-09/documents/sdwa_petition16-000-6065_mall_nrdc_aquifer_exemption_003.pdf

nearby domestic, livestock, and irrigation water supplies and destroy the livelihoods that depend on those water supplies.

DWQ Response

The revised financial assurance and bond estimate that was open for public notice and comment includes wellfield rinsing with bicarbonate solution to restore groundwater to enhance and expedite attainment of water quality goal and to protect USDWs and other sources of drinking water.

48. Comment

*6.2.2. The DWQ and LVMC have not established reclamation goals or the methodology for establishing those goals. Even those goals might not be attained. The DWQ, in responding to public comments on the LVMC Class III UIC Permit stated: “Following in situ copper recovery, groundwater will be restored in the BC Aquifer until water quality parameters have reached levels **that are technically and economically feasible** to achieve per Part III.G and Attachment H of the Draft Permit (DWQ 2020a).”⁹ It is apparent from this statement that the DEQ will allow the LVMC to modify the reclamation goals, based on technical infeasibility and/or financial considerations. Therefore, reclamation goals will be more like a wish list, than achievable goals for the exempted aquifer and nearby non-exempted aquifer.*

DWQ Response

For both points under comment 6.2 The AE Request Table 3 provides baseline water quality standards for the BC and N Aquifers that will be relied upon initially in the project but may be updated as more monitoring information becomes available. During groundwater restoration monitoring will provide information that will determine if these standards or alternative standards can be achieved technically and at reasonable economic expenditures.

49. Comment

7. Regulatory Criteria and Guidance

7.1. Environmental Protection Agency Regulations — 40 C.F.R. 144.7 and 40 C.F.R. 146.4.

The EPA regulations at 40 C.F.R. § 146.4 Criteria for exempted aquifers, applicable to Class III wells:

⁹ Lisbon Valley Mining Company LLC, Underground Injection Control (UIC) Class III Draft Area Permit No. UTU-37-AP-5D5F693. Utah Department of Environmental Quality, Division of Water Quality Public Comments and Responses, Public Hearing and Comment Period from: October 31, 2020, to January 11, 2021. Comment 4.13: Division Response, page 26.

§ 146.4 Criteria for exempted aquifers.

An aquifer or a portion thereof which meets the criteria for an “underground source of drinking water” in § 146.3 may be determined under § 144.7 of this chapter to be an “exempted aquifer” for Class I-V wells if it meets the criteria in paragraphs (a) through (c) of this section. Class VI wells must meet the criteria under paragraph (d) of this section:

(a) It does not currently serve as a source of drinking water; and

(b) It cannot now and will not in the future serve as a source of drinking water because:

(1) It is mineral, hydrocarbon or geothermal energy producing, or can be demonstrated by a permit applicant as part of a permit application for a Class II or III operation to contain minerals or hydrocarbons that considering their quantity and location are expected to be commercially producible.

(2) It is situated at a depth or location which makes recovery of water for drinking water purposes economically or technologically impractical;

(3) It is so contaminated that it would be economically or technologically impractical to render that water fit for human consumption; or

(4) It is located over a Class III well mining area subject to subsidence or catastrophic collapse; or

(c) The total dissolved solids content of the ground water is more than 3,000 and less than 10,000 mg/l and it is not reasonably expected to supply a public water system.

(3) It is not reasonably expected to supply a public water system.

The Burro Canyon Aquifer in the Lower Lisbon Valley does not meet the requirements for an exempted aquifer, because 1) it currently serves as a source of drinking water and 2) it can serve as a future source of drinking water. Just because there is mineralization in the Burro Canyon Aquifer, does not automatically eliminate it from consideration as a drinking water source, particularly since the Aquifer is an existing source of drinking water.

A recent Department of Energy Report, “Monticello Mill Tailings Site, Operable Unit III, Annual Groundwater Report May 2019–May 2020, December 2021,”¹⁴ describes the Burro Canyon Formation as “a regional water supply aquifer.”

The alluvial aquifer is underlain by the Mancos Shale, Dakota Sandstone, Burro Canyon, and Morrison Formations (Figure 3). The Mancos Shale is not shown in Figure 3 because it is completely

eroded away below the aquifer within the valley except to the west of the former mill site. The Dakota Sandstone forms an aquitard beneath the alluvial aquifer until about 0.6 mile downgradient of the former mill site. There, the formation is absent due to erosion in the Montezuma Creek valley. This exposes the permeable Burro Canyon Formation, a regional water supply aquifer, allowing direct hydraulic communication with the alluvial aquifer.

¹⁴ *Monticello Mill Tailings Site, Operable Unit III, Annual Groundwater Report May 2019–May 2020; U.S. Department of Energy, Legacy Management; December 2021 https://lmpublicsearch.lm.doe.gov/lmsites/s30735_mnt_qw_may19-may20_dec2021.pdf [Emphasis added.]*

The EPA regulations do not automatically exempt a section of an aquifer that is a regional water source just because a portion of the aquifer contains minerals or hydrocarbons that, considering their quantity and location, are expected to be commercially producible. Just because LVMC demonstrated that it contains minerals that are expected to be commercially producible, it does not automatically follow that the aquifer cannot in the future serve as a source of drinking water.

There is no statutory basis for the criteria in section 146.4(b)(1), which appears to elevate the potential for production of minerals, hydrocarbons, or geothermal energy above EPA's duty to protect USDW. To do so violates the Safe Drinking Water Act. Congress intended contamination of underground sources of water to be prevented "if there is any reasonable likelihood that these sources will be needed in the future to meet the public demand for water and if these sources may be used for such purpose in the future."¹⁰ Congress did not make any exception to the rule that all potential sources of water must not be endangered.

DWQ Response

DWQ's responses to Comments 36, 41 and 41 address Comment 49 (7.1).

50. Comment

7.2. Utah UIC Regulations - R317-7-5. Prohibition of Unauthorized Injection

7.2.1. Utah Rule R317-7. Underground Injection Control (UIC) Program, provides certain requirements for a Class III UIC Permit, which apply to area proposed for an Aquifer Exemption. Section defines Class III wells as wells that inject for extraction of minerals, including in situ production of uranium or other metals from ore bodies that have not been conventionally mined. R317-7-5 states:

¹⁰ H.R. Rep. No. 93-1185. *supra* note 6. at 32.

5.1 Any underground injection is prohibited except as authorized by permit or as allowed under these rules.

5.2 No authorization by permit or by these rules for underground injection shall be construed to authorize or permit any underground injection which endangers a drinking water source.

5.3 Underground injections are prohibited which would allow movement of fluid containing any contaminant into underground sources of drinking water if the presence of that contaminant may cause a violation of any primary drinking water regulation (40 C.F.R. Part 141 and Utah Primary Drinking Water Standards R309-200-5), or which may adversely affect the health of persons. Underground injections shall not be authorized if they may cause a violation of any ground water quality rules that may be promulgated by the Utah Water Quality Board. Any applicant for a permit shall have the burden of showing that the requirements of this paragraph are met.

7.2.2. The Division has not provided any information that demonstrates that the proposed Lower Lisbon Valley ISL copper recovery project would not endanger a drinking water source and would not would allow movement of fluid containing any contaminant into underground sources of drinking water if the presence of that contaminant may cause a violation of any primary drinking water regulation (40 C.F.R. Part 141 and Utah Primary Drinking Water Standards R309-200-5), or which may adversely affect the health of persons.

7.2.3. The Burro Canyon Aquifer is currently an underground source of drinking water. The Burro Canyon Aquifer 1) contains a sufficient quantity of ground water to supply a public water system; 2) currently supplies drinking water for human consumption; 3) contains fewer than 10,000 mg/l total dissolved solids (TDS); and 4) is not an exempted aquifer. The Burro Canyon Aquifer, as shown on the various Maps and Figures submitted by LVMC to the DWQ, supplies water for irrigation, stock watering, and domestic use in the Area of Review and within the original proposed Aquifer Exemption Boundary.

7.2.4. The LVMC has not established Baseline Water Quality in the South East area of the project.

DWQ Response

This comment is addressed by DWQ response to Comment 47.

51. Comment

7.2.5. The LVMC Internal Memo: Summary of the Ground Water Occurrences within the Lower Lisbon Valley Area, February 16, 2020, was “prepared in order to summarize the occurrence of ground water within the BC Aquifer of the Lower Lisbon Valley Area, and the rationale behind this

conclusion.” LVMC investigated the Ground Water Occurrence in the Dakota-Burro Canyon Formations, SE UIC Project Area, Lower Lisbon Valley, San Juan County, Utah. The area investigated was South East area of the original proposed Aquifer Exemption Boundary, which ends at the Utah/Colorado border and includes the Wilcox domestic/agriculture Well 05-3907/05-3575 and the State Line Deposit. This Memo established the presence of ground water and hydrological connectivity in the Burro Canyon Aquifer in this area. According to the Memo, page 5:

Exploration Groundwater Flows

The area from Flying Diamond to the Colorado Stateline has been extensively drilled. Figure 3 is a compilation of drilling records documenting depth at which groundwater flow was observed along with estimates of final flows at total depth using a 5-gallon bucket test. And although not monitoring wells, the number and areal extent of exploration holes document consistent groundwater occurrence and substantial flows over the greater than two-mile distance from Flying Diamond to Stateline.

Stock well 05-3575 is located near the Stateline deposit (see Figure 2).

This well is screened in the upper BC Aquifer and documents a hydraulic head 45 feet below ground surface (bgs).

Groundwater flows attenuate and finally terminate on the SE end of the Stateline Deposit where geologic structure elevates the Morrison Formation above the BC Aquifer hydraulic head. Figure 3 includes an expanded view

The Memo concludes:

The combined information supports the occurrence of BC Aquifer groundwater along an approximate 2.5 mile transect in the SE Project Area. This information suggests the occurrence of groundwater in the BC wherever it is down-dropped below 6200 feet amsl. These observations correlate well with the greater Project Area and support a common aquifer.

DWQ Response

DWQ responds to comment 7.2.5 by noting that the AE defines a portion of the BC Aquifer that is eligible for exemption as it is not and cannot be a USDW in the future. The portion can be common to other regions of the aquifer that may be USDWs and there is no UIC rule stating that an entire aquifer must be exempted.

52. Comment

7.2.6. The LVMC Internal Memo–Summary of the Exploration Activities within the Lower Lisbon Valley Area, and the subsequent delineation of mineralization found there, shows that the Flying Diamond Deposit is close to the Wilcox Well 05-3907/05-3575, which has now been arbitrarily excluded from the Aquifer Exemption Boundary.

7.2.7. The injection of the proposed lixiviant, a raffinate containing a dilute sulfuric acid solution, into the Burrow Canyon Aquifer would allow movement of fluid containing sulfuric acid, uranium, and other contaminants into an underground source of drinking water. It would allow for the movement of contaminants from the well field to the Wilcox Well 05-3907/05-3575, used for domestic, irrigation, and stock watering purposes.

The Wilcox well draws water from the same aquifer that will receive the lixiviant. There are no geologic barriers between the proposed wellfield and the Wilcox Well outside the proposed Aquifer Exemption Boundary. The LVMC has not proposed any monitoring well that would be able to determine if fluids and mobilized contaminants from the ISL project have reached the Wilcox Well.

The Aquifer Exemption Boundary in the area of the Wilcox Well does not include a buffer zone beyond the proposed monitoring well in that South East area. The monitoring well appears to be right on the edge of the Aquifer Exemption Boundary.

There is no information in the DWQ Aquifer Exemption Request or the LVMC Application regarding how far an excursion of the lixiviant and the contaminants mobilized by the lixiviant would travel before being detected and recovered. There is no information regarding the extensive history of ISL uranium recovery operation excursions, spills, leaks, mechanical failures, and other events.

There has been extensive exploratory drilling in the area. As discussed in the 1986 NRC Report, improperly constructed and plugged drill holes provide a pathway for vertical excursions. There is no information in the DWQ Aquifer Exemption Request that analyzes this possibility.

There is no data that would substantiate an assumption that any excursion would be recovered and the area would still be a clean, uncontaminated source of drinking water. Also, there is no evaluation of the long-term impacts from the ISL operation to the ground water quality in the South East Area of ISL project.

DWQ Response

The Permit conditions that will contain leach solutions within the Permit Area and AE through operational controls, detect leach solution migration through monitoring, mitigate any leach solution migration through contingency actions and restore groundwater after ISR. This public notice and comment subject matter pertain to the AE and Permit financial assurance and not the operation, monitoring and groundwater restoration plans.

53. Comment

7.2.8. The regulation states: "Underground injections shall not be authorized if they may cause a violation of any ground water quality rules that may be promulgated by the Utah Water Quality Board." The regulation here says "may cause" a violation of any groundwater quality rules. Because the proposed ISL operation will impact the existing Burro Canyon Aquifer drinking water source and is extremely close to a well that is used for domestic purposes, LVMC and the Division have no basis for concluding that the underground injections associated with the ISL project will not cause a violation of any groundwater quality rules. The lack of any geological or hydrological barriers between the proposed well field and the Wilcox Well means that the proposed ISL project not only "may," but most likely "will," cause of a violation of drinking water rules, will endanger a drinking water source, and will adversely affect the health of persons.

DWQ Response

R317-7-5.1 states that any underground injection is prohibited except as authorized by permit or as allowed under these rules. The Permit allows injection of leach solutions for ISR and protects groundwater outside the AE per Response under comment 52 above.

54. Comment

7.2.9. The DWQ Aquifer Exemption Request and the LVMC Application do not contain an analysis of the ability of the proposed monitoring plans to limit impacts of excursions to groundwater, existing wells, and areas outside the Aquifer Exemption Boundary.

DWQ Response

DWQ response to comment 52 above addresses this comment. Permit conditions were developed by DWQ analysis of operating, monitoring and groundwater restorations plans to ensure they were adequate to protect groundwater and USDWs outside the Permit Area and AE.

55. Comment

7.2.10.. *The LVMC Technical Report Appendix J, is a 22-page Ground Water Resources Report, Lisbon Valley Mining Company LLC, Lower Lisbon Valley Project, Supplemental Environmental Impact Statement (SEIS), dated March 2020.*

The SEIS states in regard to the scope of the proposed action: “The Company is planning to expand current conventional open pit mining operations as well as implement in-situ recovery (ISR) operations in the Lower Lisbon Valley Mining District of San Juan County, Utah.” The scope of the very brief and inadequate SEIS is for both an expanded open pit/heap leach operation and the proposed ISL operation. It states in regard to the effects on the Burro Canyon Aquifer:

*ISR activities would involve the exempting of the BC aquifer only as it exists within the LLV ground water study area. The localized and perched alluvial aquifer would not be exempted, nor would the N aquifer. As the BC aquifer is confined geologically and structurally within the study area, the **effects to the BC aquifer would be considered major, localized, and long-term.** [Emphasis added.]*

7.2.11. *In Sum: The proposed UIC Class III Permit and Aquifer Exemption Request must be denied because the proposed underground injections should be prohibited due to the fact that the injection would endanger a drinking water source and would allow movement of fluid containing contaminants into underground sources of drinking water. The presence of those contaminants would cause a violation of any primary drinking water regulation (40 C.F.R. Part 141 and Utah Primary Drinking Water Standards R309-200-5). The presence of those contaminants would adversely affect the health of persons who live adjacent to the proposed ISL site and to those who use nearby wells for drinking and agricultural purposes.*

7.3. EPA Memorandum — Enhancing Coordination and Communication with States on Review and Approval of Aquifer Exemption Requests Under SDWA. June 24, 2014.

7.3.1. *The purpose of the Memorandum “is to promote a consistent and predictable process for the review of Aquifer Exemption requests under the Safe Drinking Water Act (SDWA).” The Memo states:*

III. Recommended Steps for Facilitating the Aquifer Exemption Review and Approval Process

*As indicated above, most aquifer exemption requests have clearly met the regulatory criteria in 40 CFR 146.4, and reviews have been completed in a timely manner. **There are some aquifer exemption requests, however, that have proven to be considerably more complex to review. These more complex aquifer exemption requests have not been limited to substantial program***

revisions; in some cases, nonsubstantial aquifer exemption requests have proved quite complex as well. Typically, these have involved situations where the proposed exempted area is located adjacent to an underground source of drinking water (USDW) that is currently in use, or where the potential future use of the USDW is unclear. [Emphasis added.]

The DWQ Aquifer Exemption Request to the EPA is a complex request. It involves a proposed exempted area that is located adjacent to an underground source of drinking water (USDW) that is currently in use for domestic, irrigation, stock watering purposes. It is the mainstay of a nearby family ranch and livestock operation. Water from the well is also used by wildlife in an area with few surface water sources. Additionally, there are local community concerns and opposition to the proposed ISL copper recovery operation. These concerns and opposition have been brought forward at two public hearings and a public comment period.

DWQ Response

DWQ has provided public notice and solicited public comment according to R317-7-13 and 40 CFR 124.10, 124.11, 124.12, and 124.17 and has addressed public concerns in the November 8, 2021 Permit Response. This Response document addresses public comments on the AE Request and Permit Financial Assurance in response to the Permit public comments. DWQ agrees that this is a complex AE and has provided all the information necessary for EPA to make its decision. DWQ has informed EPA of the Permit actions and pending AE request and will work with EPA during that process to address and other conditions or facts that may arise during their review and decision process.

56. Comment

7.3.2. The Aquifer Exemption Checklist

The Checklist, under Regulatory Criteria regarding “Demonstration that the aquifer or portion thereof does not currently serve as a source of drinking water per 146.4(a),” requests the submittal of information related to wells in the vicinity of the proposed exempted Aquifer:

*Are there any public or private drinking water wells within and nearby the proposed exempted area for which the proposed exempted portion of the aquifer might be a source of drinking water
Y / N*

If yes, list all those wells Include: pertinent map(s) visually showing the areal extent of exemption boundary, depth and thickness of the aquifer proposed for exemption, all known subsurface

structures such as faults affecting the aquifer, and each of the inventoried water well locations by well # or owner name.

Include: Table of all inventoried water wells showing: Well Name/#, Owner, (Private/Public), Contact information, Purpose of well (Domestic, Irrigation, Livestock, etc.), depth of source water, name of aquifer, well completion data, age of well (if known), and the primary source of well data (Applicant/State/Tribe/EPA).

Include: Map showing the areal extent of exemption boundary, all domestic water wells considered potentially down gradient of the exemption and hydraulically connected to the exemption. If wells are deemed horizontally and/or vertically isolated from the exemption, this should be foot noted on the Table as well. Use arrow (s) to indicate the direction and speed of GW in the aquifer.

Are there any public or private drinking water wells or springs capturing (or that will be capturing) or producing drinking water from the aquifer or portion thereof within the proposed exemption area? Y/N

Evaluate the capture zone of the well (s) in the area near the proposed project (i.e., the volume of the aquifer(s) or portion(s) thereof from within which groundwater is expected to be captured by that well). A drinking water well's current source of water is the volume (or portion) of an aquifer which contains water that will be produced by a well in its lifetime. What parameters were considered to determine the lifetime of the well?

There is a well nearby the proposed exempted area for which the proposed exempted portion of the aquifer might be a source of drinking water. This is the Wilcox Well 05-3907. The Aquifer Exemption Checklist then lists several pieces of information that should be included in the Request, as quoted above. However, this information was not included in the DWQ Aquifer Exemption Request. The DWQ has not included "Well Owner, Contact information, Purpose of well (Domestic, Irrigation, Livestock, etc.), depth of source water, name of aquifer, well completion data, age of well (if known), and the primary source of well data." The DWQ has not indicated the direction and speed of Ground Water in the aquifer. The DWQ did not evaluate the capture zone of the well (s) in the area near the proposed project.

Therefore, the DWQ has not provided some of the necessary information in support of the Aquifer Exemption Request.

DWQ Response

The aquifer exemption “checklist” was provided as Attachment M of the Permit and is included with the AE Request by reference. A complete checklist is not required under UIC regulations for AEs but serves as a reference to determine if the criteria of 40 CFR § 146.4 are met. Response 9 below reiterates the exact criteria of 40 CFR § 146.4 that supports the AE.

57. Comment

8. Class III UIC Permit

8.1. *There are a number of issues related to the UIC Permit. One is the nature of the LVMC Class III UIC Permit and Aquifer Exemption Application. In the DWQ’s response to public comments¹¹ that questioned some of the factual statements made in the LVMC Technical Report, the DWQ stated (page 26):*

The Technical Report (LVMC 2020) is not the permit or part of the permit (DWQ 2020a). The Division required LVMC to include the Technical Report as part of its application for the permit to provide information relevant to the Division’s review of the application and to use when writing the Draft Permit. The Technical Report was provided to the public in response to a request from the public, but it is not part of this public notice package because the Technical Report itself is not part of the Draft Permit (DWQ 2020a). Moreover, LVMC revised and updated the Technical Report during the permit review process in response to requests from the Division for more information and for modifications to the proposed plan. The Draft Permit (DWQ 2020a) is the legal regulatory document that defines all permit conditions. The objective of the Division’s review of LVMC’s application and Technical Report is not to edit and finalize them, but rather to use those documents to prepare the Draft Permit document, which is the subject of this public notice and request for public comment.

The DWQ’s way of handling an application for a permit is very different from other agencies, both state and federal, that receive permit or license applications for review.

The permitting relies on an Application, including technical information, environmental analyses, and updated versions of the Application or information contained in the Application. It is the responsibility of the agency to make the full application readily available to the public for their review long before there is a notice of opportunity for public comment. It is the permitting agency’s responsibility to see that the Application is complete and that the information and data in the Application are factual. It is the responsibility of the permitting agency to ask questions

¹¹ https://uraniumwatch.org/lisbonvalleymine/DWQ_LVMC_UICpermit_commentresponses_110821.pdf

about the Application, request additional information, and request corrections if there is confusing, conflicting, or incomplete information. If new versions of the Application or supporting data are submitted, the versions should be identified as such and be made publicly available. This is a long process. This is how a regulatory that has responsibility for public health and safety and the environment should engage the applicant and the public.

A permitting agency should expect and encourage public comments on the Application itself, especially where there may be conflicting information, data, and opinions. An example of such a permitting process is the recent NRC review of the NuScale Power LLC Design Certification Application for a Small Modular Reactor. The various chapters of the Application and any revisions were made publicly available through out a lengthy review process.¹² Most of the NRC meeting with the applicant were open to the public via a phone line, and the public had an opportunity to ask questions of NRC staff and make written or verbal comments.

DWQ Response

Only the Financial Assurance condition of the Permit was open for comment during the public comment period. Public notice of the public comment period was published in the San Juan Record on November 4, 2020 and the Division solicited public comments for 68 days according to Utah Administrative Code R317-7-13 and 40 CFR § 124.10. The public participation process was described in the FSSOB published on the Division’s website with the Draft Permit. DWQ also received comments requesting a public hearing. In response to those comments, the Division held a public hearing on November 23, 2020. The Division advertised notice of the Public Hearing in the San Juan Record on November 18, 2020, and also posted the notice on its website. The goals of the public hearing were to provide information on the Draft Permit and receive public comments. The hearing was held by the Division on November 24, 2020. DWQs November 8th, 2022 Permit public comment responses were posted on its UIC website.

58. Comment

The DWQ must deny the LVMC request for an Aquifer Exemption for the proposed ISL copper recovery operation in the Lower Lisbon Valley, San Juan County, Utah.

As documented in the above comments, because the requirements for a permit under state law and EPA delegation have not and cannot be met. The aquifer exemption does not remotely meet the EPA standards and requirements for UIC programs to protect underground sources of drinking water (USDW) from endangerment by subsurface emplacement of fluids into UIC wells.

¹² Application Documents for the NuScale Design. <https://www.nrc.gov/reactors/new-reactors/smr/nuscale/documents.html>

The DWQ and the EPA have an obligation to protect any aquifers which are still of good enough quality that they have any potential to serve as a drinking water source, now or in the future. The DWQ an EPA cannot allow for contamination of an aquifer, both within and adjacent to the proposed Aquifer Exemption area that could reasonably have been expected to supply a public water system in the future.

Thank you for providing this opportunity to comment.

DWQ Response

DWQ thanks the commenter for its detailed comments and analysis of the AE request and Permit financial assurance. The AE Request clearly states the basis for DWQs recommendation of exemption of the portion of the BC Aquifer that corresponds with the subsurface volume of the uppermost groundwater aquifer within the Dakota and Burro Canyon Formations that exists beneath the Permit area. Regulations in 40 CFR § 146.4(a) require that a request for an AE demonstrate that the aquifer does not currently serve as a source of drinking water and cannot serve as a source of drinking water in the future because of limited supply and recharge and access in terms of land ownership and current water uses.

In addition, under regulations in 40 CFR § 146.4(b)(1) the portion of the BC aquifer proposed for the AE (in this case, the portion of the BC Aquifer) cannot now and will not in the future serve as a source of drinking water because it is mineral producing, and has been demonstrated by LVMC in its UIC Class III Area permit application a in situ copper recovery operation to contain minerals or hydrocarbons that considering their quantity and location are expected to be commercially producible. 40 CFR § 146.4(b)(1).

Regulation 40 CFR § 144.7(c)(1) requires a UIC Class III Permit Application that “necessitates an aquifer exemption under 40 CFR §146.4(b)(1) to furnish the data necessary to demonstrate that the aquifer is expected to be mineral or hydrocarbon producing. Information contained in the mining plan for the proposed project, such as a map and general description of the mining zone, general information on the mineralogy and geochemistry of the mining zone, analysis of the amenability of the mining zone to the proposed mining method, and a timetable of planned development of the mining zone” shall be considered by the UIC Director.

The portion of the BC Aquifer that is being requested for exemption is not a USDW and is not a source of drinking water and sufficient data and analysis has been presented by LVMC and other sources to show that the AE volume is mineralized such that the criteria of 40 CFR § 144.7(c)(1) are met.

59. Comment

jim Blankenagel < > Wed, Dec 8, 2021 at 8:43 AM To: dearley@utah.gov Cc: Scott Mcgettigan In reviewing the documents on your web page I feel your conclusions should be accepted with one modification. That would be to clip about one mile off the south east end of the exempted area. This mile is mostly private land and contains the flying diamond area which LVM has no plans to mine in the next 25 years. With this exclusion most of the public opposition would be removed. Monitoring wells should also be installed within 500 feet of the private water wells to insure water quality to these wells. My home is north west of this site above the Rio Algom mine site. Our wells are now threatened by leach water from their settling ponds. I understand the need for water quality. Thank you Jim Blankenagel

DWQ Response

The AE and Permit are for in situ mining and the are tied to the aquifer boundary. DWQ does not have the authority to change the boundary based on land ownership.

60. Comment

Ben Peeples < > Sat, Dec 25, 2021 at 5:03 PM To: dearley@utah.gov Dear Mr. Earley, Please use your authority to protect the precious water resources in Lisbon Valley. Once destroyed, it is gone forever. Allowing in-situ mining puts that resource at risk. I have been to Lisbon Valley a number of times and feel that it is a special place and deserves protection. Thank you for your consideration. Ben Peeples.

DWQ Response

The following response also applies to comments, or groups of comments found below, specifically number(s)- 63 through 67, 69, 71 through 76, 80 through 82, 84 through 86, 88 through 91 and 93.

Response

After carefully reviewing the comments from both the first and second comment period, the Division is satisfied that the UIC permit and AE meet all regulatory requirements and both are supported with sufficient documentation for issuance. None of the comments demonstrated any clear failure of factual determinations made by DWQ in the permit or AE. Additionally, the Division is satisfied that the UIC permit along with the natural geology and hydrogeology of the in-situ mining area are highly protective of groundwater and the existing beneficial uses.

Also, please see responses to comments 1 through 3 above.

61. Comment

Dear Mr. Earley,

*This is to request a 30-day extension of time for the public to comment on the Division of Water Quality Public Notice of Intent to Issue Permit, Underground Injection Control Class III Area Permit, In-Situ Copper Recovery, UTU-37-AP-5D5F693. The Notice was published on December 6, and the current end of the comment period is February 6. I request the extension because of: 1. Wide community interest in this project; there were 161 public comments sent to the Division in regard to the Class III UIC Area Permit in late 2020 and early 2021. 2. The Christmas and New Year Holidays in the middle of the comment period. 3. The need for individuals and organizations to provide financial and end of year reports in January, which take a lot of time and attention. 4. The complexity of the proposed ISL project and the relevant documentation, which include hundreds of pages of documents, some very technical. 5. The need for the Division to receive informed and substantive comments. Thank you for your attention to this request. Sincerely, Sarah Fields
Program Director Uranium Watch*

DWQ Response

Via e-mail Thursday, January 6, 2022

Dear Sarah,

Thank you for the request to extend the comment period for the Lisbon Valley Mine UIC permit. I am denying your request for an extension. As you know, DWQ has already held a 68-day comment period which included a public hearing. The current comment period is for 60 days and also includes a public hearing. DWQ is satisfied that 128 days (total) for comment and 2 public hearings are adequate to address the concerns you raise.

Sincerely,

Erica

62. Comment

I'm a retired small business owner, a USMC vet, and a good neighbor to the folks who live around me. For decades I met all of my company's commitments to landlords, vendors, employees, customers, and to state and federal authorities on regulations and taxes. My wife and I live in Moab, 45 minutes north of the Lisbon Valley Mine. This fall I spoke to one of the Lisbon Valley ranchers at-length, Scott Stevenson. He and his wife have invested a tremendous amount of time, money, and energy into their property, one of the two ranches down-valley of the mine. His well is a one-minute walk from the line beyond which the Mine proposes its exemption. Water below-ground doesn't care about this line. Drawing it on the map is not an honest representation of the risks that Scott and his neighbor, Mr. Wilcox face. The Lisbon Valley Mining Company is not a good

public citizen. It hasn't met its tax obligations, nor has it paid vendors on-time. It has tried to marginalize the local rancher's interests in what we can only regard as a hail-Mary pass by the mine to inject sulfuric acid deep underground, potentially compromising the aquifer. All of us are now painfully aware of the business model of extraction industries reaping all the profits from mining and then handing the costs to the US citizens. In Moab, we've had to watch the old Atlas Mill uranium tailings be whittled down over the course of two decades as part of the Superfund Project. Low levels of uranium have been leaching into the Colorado River for two generations and the removal cost will be in the tens of millions (for US citizens). The Lisbon Mine is attempting to play this old card; harvest the money, pay no bonds, exempt the company from liability, and the citizens take the risk. Looking beyond the two ranches, all of us in Utah today should be very concerned about water. It is clear that our governor and elected state officials are well-aware that we have to preserve what we have and to use it wisely. The Lisbon Valley Mine has proposed to take risky action with a vast area south of the La Sal Mountains and to exempt themselves from potentially high costs if the aquifer is compromised. There is a very good chance the Lisbon Valley aquifer eventually works east to the Dolores River, which flows north, eventually reaching the Colorado River near the old Dewey Bridge. That's no small risk. There are tens of millions of water users down-stream. Please stand for us citizens on this issue. Why would we believe these guys now? They have an awful track record. Thank You, Jeff Clapp Moab, UT

DWQ Response

This comment was explained in the DWQ response to public comments ([November 8, 2021 Comment Responses](#)) dated November 8, 2021 under the Group Comment 2 as “The Division does not have the authority to regulate beyond the governing UIC statute and regulations, which require financial assurance but do not otherwise impose any requirements about financial or tax status.”.

After carefully reviewing the comments from both the first and second comment period, the Division is satisfied that the UIC permit and AE meet all regulatory requirements and both are supported with sufficient documentation for issuance. None of the comments demonstrated any clear failure of factual determinations made by DWQ in the permit or AE. Additionally, the Division is satisfied that the UIC permit along with the natural geology and hydrogeology of the in-situ mining area are highly protective of groundwater and the existing beneficial uses.

63. Comment

Dear Water Quality Expert, Making an exemption to the Safe Drinking Water Act standards is totally irresponsible and will further erode trust in state regulatory agencies' abilities to protect the resources they are entrusted to protect. Water knows no boundaries, the Navajo Aquifer needs to be protected. Saying it is not currently being used for drinking water is very short sighted and

cheats our future generations and the neighbors and communities nearby. Please don't make exceptions to current safe standards. Lowering the bar for a private mining company's request makes any other standards even harder to enforce and would set a bad precedent for other entities to ask for exemptions anywhere in the state. The insurance bond amount is irrelevant, water is life, which is priceless. Please do your jobs as civil servants working under the title of Utah Division of Environmental Quality and stick to federal standards. Paula Dean concerned Utah citizen who drinks water PS. If I've sent this letter to the incorrect address, please let me know and I'll resend to the correct person.

DWQ Response

Please see response to comment number 60.

64. Comment

I have commented on this twice before and it seems that it doesn't really matter. But, I am going to comment once more. I know that alot of work has been done by the mine in drilling test holes all over the area to prove the point that there are faults etc. that will not allow any of the in-situ copper recovery material to contaminate the aquifers in question. But, I don't believe for one minute that even these tests prove that the recovery material will no be able to leach into the aquifers. Test holes are not an exact science. If it does leak into the aquifers then what? What is to stop the flow say on farther east to springs that grow grass etc. for birds and wildlife and also used by the same to live? What if it goes into the Delores River? No, I say put a stop to this production method. The revenue generated by this copper mill isn't worth the life of one bird, deer, cow, horse, elk or especially a human. Thank you for your time. Steve Deeter

DWQ Response

Please see response to comment number 60.

65. Comment

To whom it may concern We are writing once again to voice are concerns on the permitting and exemption applied for on the Burro canyon aquifer by LVMC. We have voiced these concerns for over a yr. now. The DWQ has a job to make sure there is no domestic drinking water in the exempt area, this is the DWQ's written standards for a exemption. Over and over we have sent you the water right # for our wells and that are filed with the state of Utah . Again we are drinking this water and using it for our livestock and have been for at lest 20 yrs. Even with the well being 300 ft. out of the imaginary boundary we feel the in-situ project will still deplete and contaminate the wells. For generations we have been good stewards of the land and water we have been blessed with. It sincerely goes against our responsibly to protect the land and the by-laws of DWQ's agency

to null void everything we have worked generations to develop. An invitation from 3 step B&B was offered to the DWQ at the public comment period on Jan. 18 at this time Wilcox Ranches is extending that invitation to come and visit have a meal of ranch raised beef and a clear clean glass of water from the wells we are drinking from and the hospitality of 3-step B&B. One by one family Ranches and Farms are being put out of business and losing their family heritage by big company like LVMC that don't care and foolish decisions made by government agencies . Please stop this while you and only you can !! Sincerely Mike and Joan Wilcox

DWQ Response

Please see response to comment number 60.

66. Comment

I am writing a comment to Lisbon Valley Mining Company's application for proposed construction and operation of a Class III in-situ copper recovery injection well(s) in south central San Juan County, Utah. This proposal will forever damage the aquifer including the Dakota and Burro Canyon Formations. The mine representatives state the damage will be localized to the mining operation and will not affect the aquifer used for drinking water now nor in the future. Nonsense! How can one possibly guarantee no impact on drinking water aquifers when considering how the earth itself moves and evolves? The Lisbon Valley is subject to earthquakes just like the rest of Utah. It is silly to think the poisoning of an aquifer will never move nor migrate in time, poisoning an entire productive valley. The current mine sits in one of the driest areas of Utah where every drop of water counts! We are currently in a severe drought situation that shows no signs of changing. Damaging any water in our area seems utterly absurd! Please do not approve Lisbon Valley Mine's proposed permit application to poison our water! There should be no Exemption Request granted to poison water in a location where water is as scarce as it is here. A concerned Citizen from the proposed impact area. Mary Gudgel Monticello, Utah

DWQ Response

Please see response to comment number 60.

67. Comment

David Roccaforte

2/3/2022 Thank you for the opportunity to comment again on the LVMC Burro Canyon Aquifer Exemption Class III Permit. UIC AREA PERMIT NO.: UTU-37-AP-5D5F693 The fallacy of circular reasoning occurs when an argument requires that the truth of all the premises and the conclusion all must rely on each other for the conclusion to be true. As such, the false logic of circular reasoning goes: If A is true, then B is true; If B is true, then C is true; Therefore, if C is true, then A

is true. [Inappropriate conclusion, circular reasoning] Put another way, "The circular argument uses its own conclusion as one of its stated or unstated premises. Instead of offering proof, it simply asserts the conclusion in another form, thereby inviting the listener to accept it as settled when, in fact, it has not been settled. Because the premise is no different from and therefore as questionable as its conclusion, a circular argument violates the criterion of acceptability." (T. Edward Damer, *Attacking Faulty Reasoning*. Wadsworth, 2001) Here's a simple example: A) If a wedding ring is pure gold, then it is not magnetic. [TRUE] B) If a wedding ring is not magnetic then it is not iron. [TRUE] C) Therefore if a wedding ring is not iron, then it is pure gold. [Inappropriate conclusion, circular reasoning] The logic used by the DWQ regarding the LVMC aquifer exemption permit is a textbook example of circular reasoning: A) If the Aquifer (or portion thereof) does not currently serve as a source of drinking water, and cannot now and will not in the future serve as a source of drinking water then it qualifies for exemption. [TRUE] B) If the Aquifer (or portion thereof) qualifies for exemption, then copper can be recovered via in situ mining. [TRUE] C) Therefore, if copper can be recovered via in situ mining, then the Aquifer (or portion thereof) does not currently serve as a source of drinking water, and cannot now and will not in the future serve as a source of drinking water. [Inappropriate conclusion, circular reasoning] The specific relevant language in the code states: "§ 146.4 Criteria for exempted aquifers. An aquifer or a portion thereof which meets the criteria for an "underground source of drinking water" in § 146.3 may be determined under § 144.7 of this chapter to be an "exempted aquifer" for Class I-V wells if it meets the criteria in paragraphs (a) through (c) of this section: 009 (a) It does not currently serve as a source of drinking water; and (b) It cannot now and will not in the future serve as a source of drinking water because: (1) It is mineral, hydrocarbon or geothermal energy producing, or can be demonstrated by a permit applicant as part of a permit application for a Class II or III operation to contain minerals or hydrocarbons that considering their quantity and location are expected to be commercially producible." The two bold, large-font, underlined "and's" above are critical to interpreting the criteria consistent with the intent of the statute which is to enable mineral extraction while protecting current, potential, and future drinking water. Arguing that the Aquifer does not currently serve as a source of drinking water, and cannot now, and will not in the future serve as a source of drinking water because it contains minerals that are commercially producible is classic circular reasoning. Approving the aquifer exemption permit based on this flawed logic risks making a farce of the SDWA and is counter to the intent of environmental protection regulations. The code specifies two criteria, and they BOTH must be INDEPENDENTLY true: 1. The aquifer or portion thereof does not currently serve as a source of drinking water, and cannot now and will not in the future serve as a source of drinking water. (irrespective of the presence of commercially producible minerals)... In fact, the aquifer does currently serve as a source of drinking water, and the portion proposed for exemption could now, and may in the future serve as a source of drinking water. = [Premise is FALSE] 2. The aquifer ... can be demonstrated to contain minerals ... that considering their quantity and location are expected to be commercially producible. = [Premise is TRUE] To put a finer point on the logic, how does the presence of commercially producible minerals make current or potentially drinkable water, (which is protected under the

SDWA), undrinkable? After LVMC is done injecting sulfuric acid into the aquifer it'll be undrinkable if there's any water left. But that aquifer, including the portion proposed for exemption sure is drinkable now. The presence of minerals is a necessary, but by itself insufficient criteria to justify an exemption, and as a consequence the permit should be denied. As we pointed out in the public comments to the prior version of the permit application, which was not addressed in the department's response: "Over a longer-term time horizon, the benefits of having unspoiled land and water far outweigh the guaranteed long-term environmental harm imposed chasing the short-term mirage of in-situ copper profits. The mere presence of commercial ore is NOT an appropriate basis for exempting and contaminating any USDW especially one which currently serves as a source of drinking water. The referenced "Citizen Petition" addresses this fallacy as well: 009 'Aquifers should not be exempted solely on the basis that they are mineral, hydrocarbon or geothermal energy producing... there is no statutory basis for the criteria in section 146.4(b)(1), which elevates the potential for production of minerals, hydrocarbons, or geothermal energy above EPA's duty to protect USDWs. To do so violates the Safe Drinking Water Act and unwisely prioritizes mineral and energy production above drinking water resources.' (p 47) < <https://www.epa.gov/petitions/citizen-petition-repeal-or-amend-epas-aquiferexemption-regulations-protect-underground> >" A public response from DWQ to explain and reconcile the logic behind declaring the aquifer (or portion of aquifer) as "not currently serving as a source of drinking water, and that it cannot now, and will not in the future serve as a source of drinking water" because of the presence of commercially producible copper (rather than based on potability standards, for instance), would be appreciated. The second comment and request for clarification I'd like to make is regarding the long-term consequences of exemption. My understanding is that once an aquifer or portion thereof is exempted, it falls out of the jurisdiction of the DWQ, and remains exempted from SDWA protections forever. There is no opportunity for redemption or restoration for the aquifer, or portion thereof, to be protected again under SDWA regulations in the future. There does not exist an UN-exemption process. I therefore question the purpose of the post-in situ restoration specified in the permit? Why bother? If I were the LVMC, I would not plan on restoring the aquifer following copper recovery. What authority would the DWQ have over LVMC to dictate what they must do with an aquifer, or portion thereof, that the DWQ no longer has jurisdiction over by virtue of having given it up for exemption? And in fact, even if LVMC were to walk away, why would the DWQ or state of UT care any more about the Burro Canyon aquifer in Lower Lisbon Valley than they would care about Lake Karachay in Russia? https://en.wikipedia.org/wiki/Pollution_of_Lake_Karachay A public response from DWQ to these questions also would be appreciated.

Thanks again, J. David Roccaforte

DWQ Response

Please see response to comment number 60.

68. Comment

RE: Proposed Aquifer Exemption for a Portion of the Aquifer in Lower Lisbon Valley, San Juan County, Utah. Lisbon Valley Mining Co. LLC. UTU-37-AP-5D5F693. Dear Mr. Earley: Below please find comments on the proposed Aquifer Exemption for a portion of the Lower Lisbon Valley, San Juan County, Utah. Comments are responsive to the December 8, 2021, Division of Water Quality, Department of Environmental Quality, Public Notice of Intent to Issue Permit, Underground Injection Control Class III Area Permit, In Situ Copper Recovery. Comments are submitted on behalf of the Eastland Special Service District (ESSD), a Utah public culinary water system due south of this proposed project.

1. Introduction We write to oppose the Aquifer Exemption requested by the Lisbon Valley Mining Co. LLC (LVMC) in conjunction with the proposed Class III Underground Injection Control (UIC) Permit for an in-situ leach (ISL) copper recovery operation. The Division of Water Quality (DWQ) should deny the Aquifer Exemption Request, based on the following: The Burro Canyon Aquifer in the Lower Lisbon Valley is a current and future source of drinking water. The proposed Aquifer Exemption is geologically and hydrologically connected to several nearby sources of drinking water. The DWQ's review of the Class III UIC Permit and Aquifer Exemption Request does not meet EPA requirements: as the November 4, 2020, and December 8, 2021 fact Sheet and Statement of Basis (FSSOB) do not meet the EPA 40 C.F.R. Section 124.8 requirements for a UIC Permit fact sheet.

2. Excerpts from the ESSD Source Protection Plan (SPP) Of March 10, 2000 010 Prepared by Shephard-Wesnitzer, Inc an Engineering firm of Flagstaff, AZ Based on information in the ESSD SPP from the drilling log and local stratigraphy, water (in Eastland) is available from aquifer material between depths of 1084 and approximately 2100 feet. This interval includes the Entrada Sandstone, Carmel Formation, Navajo Sandstone, Kayenta Formation, and Wingate Sandstone. However, since the well is perforated between depths of 1200 and 1700 feet, most of well water is believed to come from the Navajo Sandstone, with possible minor contributions from the Wingate Sandstone. Because the outside of the casing was cemented below 2500 feet, no water enters the well from below this depth. Therefore, brackish water from the deeper portion of the well in the Paradox Formation are excluded. As stated previously, no pump tests or other standard well tests have been performed to characterize the (ESSD) aquifer. The only available hydraulic and hydrologic data from the well is the static water level, perforated interval, and pump characteristics. Most of the information on the aquifer was obtained from published studies. The following assumptions apply to all preceding equations (in the report):

- 1. The aquifer is homogeneous, isotropic, saturated, fully confined, & laterally extensive*
- 2. Pumping rate is constant.*
- 3. Flow is laminar and radial (no vertical flow).*
- 4. Aquifer thickness is constant.*
- 5. The well fully penetrates the aquifer.*
- 6. The well radius is negligible.*

This SPP document further states... it is only fair to say that a more detailed analysis (which would be very expensive) may be necessary in the future if the ESSD water system is significantly augmented (or contamination may occur from a nearby source such as proposed by LLVM). It was engineered for 39 residential connections plus fire hydrants. However, if in the future this system must support, say, a residential subdivision in the Eastland area, then a more detailed analysis is highly recommended. Such an

analysis may in fact reduce the size of the protection zones, which were determined using conservative estimates and computations. 3. *Aquifer Exemption Request* The *Aquifer Exemption Request* to be submitted to the EPA Region 8 is incomplete and misleading. The DWQ *Aquifer Exemption Request* should contain maps of the proposed wellfields in each ISL deposits (and their proximity to the ESSD water system): Instead, there is a very rough map with only a few wells indicated (Figure 2, page 6) and a diagram of typical wellfield configuration (Figure 3, page 7). This does not provide the EPA, or the public, with complete and accurate information on the placement of the wells associated with the ISL operation. The ISL operations will, in fact, have an adverse impact on existing activities. The DWQ received numerous comments on the Class III UIC Permit for the project that document and discuss numerous adverse impacts to nearby residents and their livelihoods. Such as:

- Potential to contaminate nearby domestic wells in the Burro Canyon Aquifer.
- Reduction of available water due to depletion of the aquifer.
- Radon and other radioactive emissions that will not be monitored or mitigated
- Disturbance to domestic livestock and wildlife
- Negative impact on customers of nearby year-round recreational businesses 010
- Adverse impacts to the economic, social, and individual and community health
- Destruction of historic community livelihoods

4. *Incomplete Identification of Area Municipal Water Supplies* The discussion of *Private and Public Wells Outside the Permit Area / Aquifer Exemption Boundary*. page 21, discusses possible impacts to water for the City of Monticello and the towns of La Sal, Utah, and Egnar, Colorado. However, there is no mention of potential impacts to the public well and aquifer that supplies water to the Eastland community. The DWQ does not have a lot of important information necessary to evaluate the ISL proposal and its potential impacts on the exempted area and nearby aquifer. That data will be collected after the UIC Permit and AE are approved, which is too late. Considering the past history of Uranium ISLs, it is most likely that the nearby Wilcox well will be contaminated. There is no way to demonstrate that it will not, or that it would be remediated. Even if it could be cleaned up, how long would that take and what would family/ranch do in the meantime? Given the distance and geologic structures, Eastland may not be impacted, but that is not adequately demonstrated in the DWQ AE request. 5. *Regulatory Criteria and Guidance* A major concern of the proposed ISL project is the migration of injected lixiviant and mobilized copper, uranium, and other minerals outside the Exempted Aquifer and into nearby *Underground Sources of Drinking Water (USDWs)*. According to the DWQ *Aquifer Exemption Request* (page 28), "A number of factors, including Class III Area Permit requirements, led the Director to the conclusion that adjacent USDWs will not be impacted by ISR contaminants crossing the AE boundary or migrating vertically." However, that determination relies on future actions, testing, and verification to prove its assumptions. Thank you for your consideration of our comments. For the ESSD Board ---Scott Johnson, Kay Randall, Warren Peterson, Gary Romesha and Janet Ross, Board Chair ESSD

DWQ Response

As explained in Comment 2, the portion of the Burro Canyon (BC) aquifer defined in the Aquifer Exemption (AE) request is not a current or future source of drinking water as explained in the AE, Section Basis for Decision, pp. 18-23.

Comment 13 expresses that DWQ has provided a series of data-driven results in the AE request that there has not been detectable vertical movement in the geologic history of the BC and N Aquifers and that there will not be horizontal and vertical migration of contaminants from the AE. These results are found in the AE Request, Section Other Considerations, Demonstration That the Injection Zone Fluids Will Remain Within the Aquifer Exemption Area, pp 28- 33.

The ESSD aquifer, which is the N aquifer, has been characterized by several pump tests. A number of studies were performed to evaluate the aquifers, 5 in BC and 2 in N aquifers (LVMC report, Project Area Pumping Tests section). Well yields, hydraulic conductivities, well hydraulics, aquifer properties were evaluated. There were also a number of pumping tests conducted from 1995-2013, including the N aquifer (LVMC report, LVMC Pump Testing 1995-2013 section).

The AE request dated 12/8/21 does in fact show the proposed wellfields of each ISL deposit (GTO, Lone Wolf, Flying Diamond). The exact placement of the wells will vary based on localized hydrogeology LVMC Technical Report, Part O – Expected Changes Due to Injection section). The placement will be based on clusters 5-spot well patterns that will be assessed during a Class V tracer injection test (starting at GTO) using NaCl. LVMC is currently developing the application.

Reasonable, well justified data analysis of well placement for the ISL has been provided. These comments have been addressed throughout the DWQ comment responses.

As stated in the AE Request, Private and Public Wells outside the Permit Area section, the Wilcox and Stevenson wells are outside of the AE but within the AOR. They are not screened in the AE aquifer. The hydrology for the Monticello, La Sal, and Egnar wells is described and why hydrologic isolation is justified. Because the Eastland well is screened in the N aquifer, substantial justification for hydrologic isolation has been provided.

The UIC permit is required before the AE is approved by EPA. Then the permit is subject to further in-situ conditions to verify the macro-scale geohydrology. Several conditions exist in the draft Permit for further investigation to revoking the Permit.

DWQ has described a number of reasons that geologic conditions exist to prevent migration into USDWs (see AE request, Confining Zone section).

- **Lateral geologic structure, non-transmissive faults**
- **Water levels indicate not connected**
- **Impermeable top and bottom layers**
- **Clay material at adjacent faults**
- **WQ very different between aquifers**
- **Isotopic analysis of recharge water and ages**

69. Comment

Please regard this email as Public Comment for the deadline of February 8th 2022 regarding the amended permit attachments for Lisbon Valley Mine. I believe the DWQ is failing to fulfill your primary mandate to protect Utah's water quality in the Burro Canyon aquifer. By injecting the forever chemicals and poisons into this aquifer, it will be exempt from environmental protection. It will be exempt from the standards set by the Safe Drinking Water Act. I am currently paying on a thirty year CIB loan for a water tap from Eastland Special Services District. This Community well is a short distance of 24 miles, from your In Situ mining project. I believe that the drought conditions and your business proposal for the poisoning of the water, will definitely affect the LEVEL AT WHICH WE PUMP OUR COMMUNITY WATER. If we lower our water level pumping, we hit arsenic. And eventually, your 3,000 chemical injections will affect our healthy water. ESSD submitted a letter from our Board at the last public hearing. Your answer was non specific and without proof. You are ignoring the dangers to this small enduring community, its health, water supply and eventual ability to survive without potable water. You are not addressing environmental degradation, contamination and related health repercussions over time. Our area has experienced two Superfund clean up sites in Monticello. You are creating without conscience, a third site in Lisbon Valley. Do not poison the aquifer in Burro Canyon and tell our water users next to you, that it will have no effect. We are all connected in a relationship of water, air, climate and drought temperatures. The financial backers, stock holders, Wall Street investors, live elsewhere, far from our concerns. They privilege free markets and have privatized access to profit, over any other socioeconomic concerns. I ask you to represent US so that we are not just another sacrifice zone in this County. Thank you. Susan Smith

DWQ Response

Please see response to comment number 60.

70. Comment

To: the Utah department of Environmental Quality. This is Josh Nielson from San Juan county. I heard that the Lisbon Valley Copper Mine is deciding whether to use in situ mining to get resources. I think that it's a good idea. It seems a lot easier to do in situ mining. I think some benefits of in situ mining are first, getting more resources which means more money. Next, Is jobs. More people

can have jobs after opening up in situ mining. So I think in situ mining would be a good thing to have.

Sincerely, Josh Nielson

DWQ Response

Thank you for your comment.

71. Comment

Chad Yellow < > Mon, Feb 7, 2022 at 9:10 AM To: dearley@utah.gov To: Utah Department of Environmental Quality Hello my name is Chad Yellow from San Juan High School. My class has learned about how the Lisbon Valley Mine wants to use the in-situ technique of mining. I believe that the Lisbon Valley Mine should not in-situ mine. I say this because the water that they put in the ground has bad minerals which is sulfuric acid and that can contaminate the groundwater which will affect the people, plants and wildlife that live in the bounties of where they want to mine.

DWQ Response

Please see response to comment number 60.

72. Comment

Taryn Nielson < > Mon, Feb 7, 2022 at 9:11 AM To: dearley@utah.gov I think that Lisbon Valley Mining should not be situ mining . I live blanding and I don't think they should do this because it contaminates the water. And they cannot isolate the water to one place and there is not a lot of water where we live.

DWQ Response

Please see response to comment number 60.

73. Comment

Brad Skow < > Mon, Feb 7, 2022 at 9:11 AM To: dearley@utah.gov Hello, My name is Brad Skow, I think having an In Situ Mine near San Juan is a bad thing to do. Having a mine near our county San Juan is bad because how contaminated the water can be since we are in a drought right now. Having that water can cause us, the people in San Juan county, to only rely on our well drinking water that will be contaminated by the mines you are making by mixing dangerous solutions that would ruin our water systems. Sure you make money and give people jobs, but you would also be

saving lives by not contaminating the water. I live in Blaning, a town in San Juan and we rely on wells for drinking water because we also rely on the mountain's water but we aren't getting enough of it.

DWQ Response

Please see response to comment number 60.

74. Comment

Josiah LaPalmer < > Mon, Feb 7, 2022 at 9:11 AM To: dearley@utah.gov Letter to DEQ My name is Josiah Lapalmer. the Lisbon Valley Mining CO and I was thinking that you guys could do insitumining and I think that would really help us out by making money and jobs. But the bad thing about that kind of mining is we cannot isolate the water and contain it. Also, it would contaminate the water and San Juan County would be low on water.

DWQ Response

Please see response to comment number 60.

75. Comment

Gage Rhodes < > Mon, Feb 7, 2022 at 9:11 AM To: dearley@utah.gov To Utah Department of Environmental Quality By Gage Rhodes Hi im Gage Rhodes and i'm from blanding utah i've heard that the in situ mining copper by mixing chemicals and pumping the chemicals into the rocks and pumping it back up. I am against this and dont think it will be good for the water. It could contaminate the water underground by putting chemicals into it and that would badly affect drinking water. We don't have a lot of water and I believe that we should protect it.

DWQ Response

Please see response to comment number 60.

76. Comment

Dyami Whaley < > Mon, Feb 7, 2022 at 9:13 AM To: dearley@utah.gov My name is Dyami Whaley. I live in Blanding Utah, I'm here talking about the Lisbon Valley mining Co. The Lisbon mining Co, is talking about shooting chemicals into the copper mines and bringing the copper back up to surface i wanna say i'm against that because it will affect our Ability to get more water here in san juan county and i say that because it will stay in our water systems and sulfuric acid will affect us

all and our drinking water it could maybe cause us all to get cancer or to get really sick and affect the human population here in the southern area and could in the northern too

DWQ Response

Please see response to comment number 60.

77. Comment

Brianna Denny < > Mon, Feb 7, 2022 at 9:15 AM To: dearley@utah.gov Lisbon Valley Copper Mine - Google Docs.mhtml 4047K

DWQ Response

The comment was received and responded to in comment number 98

Drummond Earley Mon, Feb 7, 2022 at 11:59 AM To: Brianna Denny < >

Brianna, Thank you for your email but I am unable to open the link, can you please send it as an email or attachment? Dusty Earley

78. Comment

*Kayden Warren < > Mon, Feb 7, 2022 at 9:18 AM To: dearley@utah.gov copper - Google Docs
Drummond Earley Mon, Feb 7, 2022 at 12:00 PM To: Kayden Warren < >*

DWQ Response

The comment was received and responded to in comment 93

Kayden, Thank you for your email but I cannot open the link. Can you please send it as an email message or attachment? Dusty Earley

79. Comment

Peyton Shumway < > Mon, Feb 7, 2022 at 9:21 AM To: dearley@utah.gov I am Peyton Shumway from San Juan county. I go to school at San Juan Highschool. My science teacher Mrs. Castellon is teaching us about in situ mining and is having us write a letter to you guys. I don't know all of the facts. All I know is that Lisbon Valley Mining Co. is going to start in situ mining for copper. From what my teacher tells me it sounds pretty bad, but like I said I don't know all the facts and bet my teacher is only telling me the bad because she is against it. What she is telling us is that we don't have a lot of water which is true we don't and the in situ mining is going to ruin what little water we have. She said that they

will shoot sulfuric acid into the ground and that they are going to hit just the tiniest stream of water and contaminate all of the groundwater. Like I said I don't even know half of anything about this and only know what she has told me.

DWQ Response

Thank you for your comment.

80. Comment

Mythias Benally < > Mon, Feb 7, 2022 at 9:21 AM To: dearley@utah.gov Dear: Utah Department Of Environment Quality Hello my name is Mythias Benally and I live here in blanding utah. So something about the mine is that the situ mining is that the chemical in the water will be mixed in the water which causes the water to be carbornide water, it will not be that good. So I am against this because it will make the water not good and it will carbonated the water and we will not have much water Mythais Benally

DWQ Response

Please see response to comment number 60.

81. Comment

Azad Kee < > Mon, Feb 7, 2022 at 10:36 AM To: dearley@utah.gov Dear Utah Department of Environmental Quality I am a highschool student named Azad that lives in San Juan county and I've heard that Lisbon Valley Mining Co will be doing in situ mining. I am against in situ mining. The reason I am against it is because what if the wildlife and the people's water will be contaminated if they use their new mining idea. The reason being is they are using sulfuric acid which is dangerous to us and the environment due to San Juan County lacking on water. Ps, azad a highschool student

DWQ Response

Please see response to comment number 60.

82. Comment

Dear Utah environmental Quality Hi I am Remington Patterson, I am 15 years old, I am from San Juan County I go to San Juan High School I am against it because we have very little water in San Juan County. I care about our environment because we don't have much water here we care about our water that we have here because we didn't have any snow storms this winter so we have very little water. We haven't had very many storms we have had a dry winter we don't need the water

and the acid here people have wells here that they get there water from. We have farmers here that need the water because they have plants that need to keep their plants alive we need all the stuff our farmers provide for us we need these plants that the farmers grow if we don't have water here the farmers can't grow their plants. Sincerely Remington Patterson

DWQ Response

Please see response to comment number 60.

83. Comment

To: Utah Department environment quality My name is Eli Litsue, I am 14 years old and I live in Bluff Utah I think Lisbon Valley Mining Co., LLC Should keep Mining because they oprevent jobs for good. Thank you so much. By Eli Litsue

DWQ Response

Thank you for your comment.

84. Comment

Eugene Martin <> Mon, Feb 7, 2022 at 10:38 AM To: dearley@utah.gov Hello Utah Environmental Quality, This is Eugene Martin. I'm a high-school student in San Juan High-School. I live in San Juan County. I think what you guys are doing is bad because we barely have any water in San Juan. I think you shouldn't put chemicals in the water. Because there's something inside the water. Living things. And you guys are putting bad chemicals in the water. You guys are going to make a big fish come out of the water. It might be crazy. And it's not goings to be cool, it going to be walking around San Juan. And thanks for not putting chemicals in the water.

DWQ Response

Please see response to comment number 60.

85. Comment

To, Utah Department of Environmental Quality My name is Javin Montella and I am 15 years old and live in San Juan county and I am concerned about the Aquifer Exemption Request from Lisbon Valley Mining Co. One reason that I am concerned is that water is always moving and with two wells right outside the boundaries it makes it so the water in the wells could get polluted. My second reason is that in San Juan county we don't have enough water to begin with so sending a bunch of chemicals into the aquifers could make it so we don't have enough water to live. My final reason is the chemicals could go off course and go into a different water source or into a city's water source then we really wouldn't have water. Thank you, Javin Montella

DWQ Response

Please see response to comment number 60.

86. Comment

Hello I am a resident of San Juan county, attending San Juan High School. My name is Donovan. I hear that Lisbon Valley Mining will be doing situ mining around the area. I am concerned that underground water will be affected with salface acid because we live in dry land and need as much water that we can. Thank you for reading my letter. Sincerely Donovan.

DWQ Response

Please see response to comment number 60.

87. Comment

Utah Department of ENVIRONMENTAL QUALITY Hi my name is Gilda Williams and i am 16 years old, a Sophomore at San Juan High School. I think that they should mind because they are helping the environment and helping people get water through pipes. So thank you for helping people out where to get things like water and stuff for their homes you know.Sorry if it does not make any sense you know. Sincerely, Gilda Williams

DWQ Response

Thank you for your comment.

88. Comment

Dear Utah Department of Environmental Quality. I am Tavin Tinsley, a 14 year old living in San Juan County. I am against the Liston Valley Copper Mining Company using "In situ" mining because of the problem it can cause to the aquifers. It could contaminate the water in the aquifers because we can not contain the water. Having the water getting contaminated will lower the amount of usable water in San Juan County. Sincerely Tavin Tinsley

DWQ Response

Please see response to comment number 60.

89. Comment

To the Utah Department of Environmental Quality, My name is Joshua Benally and I live near blanding. I am against situ mining in Lisbon Valley, because drilling water into the ground and

using acid will mess up the water. The water will get contaminated, and the wells around the mine will be non drinkable. Sincerely, Joshua Idk my teacher is getting us involved and I'm just saying what I think about this. :3

DWQ Response

Please see response to comment number 60.

90. Comment

Dear Utah Department of Environmental Quality, My name is Brianna Denny. I am from SJH in the San Juan School district. I am currently a freshman and I wanted to send this letter to you. I know that Lisbon Valley Mining Co. is wanting to mine through the ground using water. Like in Situ mining where you send water down through pipes with some sort of chemicals to dissolve the copper so they can suck up the copper through the ground. I'm against the idea of you guys doing this. Because most of the barriers that you say aren't going to contaminate our drinking water or wells, they are fairly close to some of them. You cannot isolate the water so it's going to be poisonous for us, animals and plants. Drinking water is really precious to all of us and we can't live without it at all. I know it's good for money and people are getting jobs for this but would you rather live with clean drinking water or have some poisonous water? In the end I appreciate you taking the time to read this letter and hope you have a wonderful day. Sincerely, Brianna Denny

DWQ Response

Please see response to comment number 60.

91. Comment

Dear Mr. Earley, I recently became aware of the proposed in-situ mining experiment by the Lisbon Valley Mining Co. in southeast Utah. This proposed experiment has extremely serious consequences for the surrounding landowners, specifically the very real threat of permanently poisoning their only source of water. One of my lifelong friends has a ranch immediately downstream from the Lisbon Valley Mine, and the idea of pumping acid into the ground which will then spread throughout the poorly understood geology in the vicinity should never be allowed to happen. The risk is, in plain language, simply too high. The owners of the mine appear to be making a desperate attempt at trying to rescue their own poor decision to re-open the mine by destroying the long-standing ranches along with the mine. The mine has not been profitable in the past decade; the owners haven't paid the taxes on their property to the county in several years. In contrast, the surrounding ranch owners have always found a way to live in a way that keeps the land and water resources continue to support them, and they always pay their taxes. Please, do

*not approve this unneeded and dangerous permit to pump acid into the groundwater. Regards,
Charles Stenbridge*

DWQ Response

Please see response to comment number 60.

92. Comment

Hello Mr. Earley, I am writing in regard the Underground Injection Control (UIC) Permit the Division of Water Quality is considering for Lisbon Valley Mining Co., LLC. I strongly encourage you to reject this permit application. I have been visiting the Lisbon Valley area of Utah annually for the past 7 years. This is a beautiful area, one with rich recreational opportunities. My friends and I have stayed at the 3- Step Hideaway, a local business, many times, so I am very familiar with the limited drinking water supply in the Valley, as well as great effort that has been made to conserve the natural resources. I am also familiar with the many abandoned mine sites in the Valley, almost all of which have been left in a dismal state by former operators. It makes no sense for the Division of Water Quality to allow Lisbon Valley Mining to destroy the aquifer that provides the quality drinking water for local landowners. The proposed injection of a sulfuric acid solution into the aquifer, along with contamination from the copper residue, will ruin the aquifer now and for generations to come. At best, Lisbon Valley Mining benefits in the short term, while creating a very long-term liability for all the residents and visitors of the Valley. The Division of Water Quality's mission is to protect these natural resources; granting this permit will do the very opposite. Further, Lisbon Valley Mining is years behind covering their tax liabilities, so have demonstrated little regard for fulfilling their promises and commitments to the State of Utah. Why would you partner with a such a business? The citizens of the Valley surely deserve better. Again, I strongly recommend that you deny this UIC permit, and protect the environment and resources of Lisbon Valley for everyone to enjoy. Regards, Holt Farley

DWQ Response

93. Comment

Kayden Warren < > Mon, Feb 7, 2022 at 2:53 PM To: dearley@utah.gov To: Utah Department of Environmental Quality From: Kayden Warren I am a student at San Juan High School. I live in Bluff Utah I am against situ mining in the Lisbon Valley Copper Mine because if they get their chemicals in the groundwater we will not be able to use water. If we drink bad water we will either die or get sick. Thank you for reading this.

DWQ Response

Please see response to comment number 60.

94. Comment

To whom it may concern, I am writing as a resident living west of West Summit Road. I haul my water from Monticello. I am familiar with the Lisbon Valley open pit mine, having lived here for a number of years. The Lisbon Valley mining Co (LVMC) employs a few people in the local area. The mine itself is an environmental disaster. A cursory examination of the tailings, the mortality of the Pinyon pine in the area as compared to a mile above and below indicate the mine operations have a much greater impact on the surrounding environment than meets the eye. I am aware the Pinyon pines are being attacked by mountain pine beetle, but the subsequent mortality is much greater within the vicinity of the LVMC. The mining laws of 1872 are woefully inadequate to address the impacts from this mining operation. The mine is required by law to carry a bond (currently \$38 million) to “restore” the physical environment post mining. This may happen sooner than one expects as the LVMC has been teetering on the brink of bankruptcy for years. Copper can be mined cheaper in the world and the market price for copper is such that LVMC is continually on the verge of bankruptcy. I have doubts LVMC will ever “restore” their mine, especially in light of their being almost \$2 million in arrears in their tax liability to San Juan Co. (\$1,979,321.50 owed currently). The County accepted a “plan “ that allows a minimal payment (\$1,760) such that the owed monies will be paid in 98 years. This tells me the operation is already “rogue”, not operating in good faith, and seeks to make money at any cost. LVMC will never meet their San Juan County obligations as they will be bankrupt soon. The efforts to inject sulphuric acid into the aquifer to recover copper is indicative of a last gasp ditch effort to make a buck from existing tailings before succumbing to inevitable bankruptcy. Injecting an aquifer in itself is a form of insanity, with no regard for the environment, nor its neighbors; who draw sustenance from that aquifer for their cattle and livelihood. I am both resentful and surprised this attempt has gone this far through the permit and “environmental” process. Please explain to me how injecting sulphuric acid into an aquifer is not going to ruin the water supplies adjoining the area to which it is injected? We live in a desert environment here, and all water is sacred, not to be ruined by anyone. That the proposal includes drilling “monitoring wells” surrounding the area to sample the aquifer, will accomplish what? First who will be “monitoring” these wells? LVMC? The EPA? You? We know the answer: the fox reports all is well in the chicken coop. There is no way LVMC, by their own financial track record, can be trusted to monitor their own environmental degradation. This ought to be obvious by now. What mitigative measures can be applied once the H2SO4 escapes into the adjoining aquifers, polluting them for hundreds? of years? Answer: none, the continuous aquifer will be ruined, and this will be the cue for LVMC to declare bankruptcy, shut down, move out, and try to catch them. Worse yet, is the result to the adjoining landowners and their way of life. The adjoining landowners land will be worthless, water unpalatable, thus uninhabitable. 036 To allow this permit to proceed is to destroy the environment of Lisbon Valley, making what habitation it currently has to no longer be habitable. The Company will exist no more, so there will be no one to sue legally, LVMC will never restore their environmentally disastrous mess in Lisbon Valley, the bonding Company will declare bankruptcy rather than pay out \$38 million dollars, and we citizens of Utah will be saddled with

another toxic waste dump. I strongly oppose the issuance of any permit to LVMC until first they are fully paid up to San Juan County for their back taxes. Then and only then are they to apply for their permit, then they need to conduct a series of meetings with the public within San Juan Co. with representatives of the EPA, to assure those of us who live here are assured they won't ruin the aquifer. Sincerely, Marc LaPine

DWQ Response

Please see response to comment number 62.

95. Comment

Dear Mr. Earley, I am writing to you as a concerned citizen about the proposed expansion to the Lisbon Valley Mining Company's copper mine. I am a resident of Moab with a degree in Chemistry, and I do not support the proposed expansion. The West is covered with mining's legacy, from Gold King in Colorado, to the Berkeley Pit in Montana. I do not trust that Lisbon Valley Mining Company will be able to contain the acid they inject during the proposed in situ mining process, nor be able to return the Burro Canyon aquifer to its original state afterward mining operations cease. In an increasingly dry region it is imprudent to taint any aquifer, asking for it to be exempt from the Clean Water Act. Please do not support this proposal. Thank you for your time and consideration.

Lillian Houghton Moab, UT

DWQ Response

Please see response to comment number 62.

96. Comment

Dear Mr. Drummond Earley: 7 Feb 2022 UIC Program, Utah Division of Water Quality dearly@utah.gov I was raised in San Juan County. In my almost 80 year association with it, water has always been a precious and limited commodity – even more so in this period of drought. The State of Utah has done well to established standards to protect this priceless resource. I am concerned with a proposed Aquifer Exemption Request that Lisbon Valley Mining Company has requested the state to grant. There usually is an exceptional reason for granting an exception. What is that exceptional reason? Who benefits by this exception? That this idea would even come under serious consideration is astounding to me. You have to wonder what is the benefit that is so compelling that it would require jeopardizing the livelihood of those who have lived there for generations. Most the folks in San Juan County would not be comfortable stepping on their fellow citizens in order to further their financial or political interests. There is sense of a moral and ethical obligation in the San Juan culture that would not allow that to happen. If the benefit is not what most locals would sanction, the primary benefit must be outside the area. The whole of Lisbon Valley has become holy. That is, it has acquired an extensive set of deep holes due to people drilling there while looking for oil, uranium, water and other minerals. Under these circumstances, water

in a subterranean aquifer is not constrained by man-made surface boundaries. Additionally much of the subterranean soils in that area are of sandstone, a rock known for its permeability and porosity. There is a supposition that the acid based lixiviant, injected into the aquifer in one part of the valley would not find its way into one of the countless holes peppering the valley and thus, contaminate an aquifer in another part of the valley. That idea is simply full of holes and just won't hold water! 038 The proposed Aquifer Exemption Request indicates that; "Approximately 200 to 700 ISR wells will be operational at any given time during the project The total rate of flow of lixiviant (which is defined below in the In-Situ Recovery Process section) that will be recirculated in the ISR wellfields ranges from approximately 5,000 to 20,000 gallons per minute (gpm)." Not all that water will be recovered. When you consider 200 – 700 wells will be operational at any given time you certainly would not expect to recover 100% of that water. Especially given the myriad of already existing wells, strewn through the valley plus the faults, fractures, cracks, fissures and the porosity & permeability of the mostly sandstone soils. Additionally, some will be lost to evaporation in the leach ponds. That lost water will need to be replaced. How many gallons per minute of new water will be required to replace water that was lost and not recovered? . I have not been able to determine this from any of the documents I have read Consider that you are successful in recovering 99% of the lixiviant. Given many avenues for water to escape, as mentioned previously, I seriously doubt 99% could be recovered. However even if you take the lowest amount of 5,000 GPM and grant a successful recover rate of 99% that would leave 1% of that 5,000 GPM or 50 GPM that would not be recovered. That means 50 GPM would be needed to replace what was lost and not recovered. This is a critical question because on the 3 Step Hideaway ranch alone, their well can only produce 360 Gallons per day. And they are not the only ones pulling water from the aquifer. The replacement amount needed for just one hour of operation, considering a 99% recovery rate, would be 3000 gallons (50 GPM for 60 Minutes). The replacement water needed for just one hour of operation is over 8 times what 3 Step Hideaway can produce in an entire day! That is not even considering what other ranches & farms use. 038 If the company were using 20,000 GPM of recirculating lixiviant with a 99% recovery rate, (doubtful) that would require replacement water to the tune of 12,000 GPM an hour. Where are they going to get that much of water? The aquifer would be sucked dry! Based on their past performance, when they sucked dry the aquifer and it proved no longer profitable they would leave, and leave the permanent residents to pick up the pieces and to try cleaning up their mess. Just like they have left San Juan County citizens paying more taxes because of their company failed to pay their fair share of taxes. Even if they somehow were able to run the operation for the estimated 20 years, I have no confidence that these temporary residents would leave the area without long term undesirable consequences. The amount of the bond proposed is based only on estimates. Estimates which I am sure were least damaging to the mining company. They really have no true idea of where that water will go, or what damages may result by their process. They only provide estimates that show them in the best light. I have heard it mentioned that quantity of water is not of concern, only the quality. How can that be? If there is no water, (i.e. no quantity) then quality is irrelevant and meaningless. 038 In summary, • There simply is not enough water for that operation. This is a

quantity and a quality issue and it is of great concern to the citizens of San Juan County • The risk to the priceless aquifer is simply too great. • There is little confidence that the company will keep its promises & leave the area unscathed. • It puts in jeopardy the livelihood of property owners. Some who have lived there for generations. • Allowing such an egregious exception is akin to selling your birthright for a mess of pottage. Thank you for allowing me to comment on this important and vital subject. I trust you will do the right thing and continue providing Utah with excellent water resource protection. Sincerely, Larry Lyman Washington, County, Vested San Juan County Citizen

DWQ Response

UIC Class III solution mining regulations do not require a proponent to demonstrate experience with such projects but only to submit a viable plan to do so with the permit application per 40 CFR §146.4(b)(1).

The Permit conditions require that LVMC will contain leach solutions within the Permit Area and AE through operational controls, detect leach solution migration through monitoring, mitigate any leach solution migration through contingency actions and restore groundwater after ISR. However, this public notice and comment subject matter pertain to the AE and Permit financial assurance and not the operation, monitoring and groundwater restoration plans.

In the LVMC Technical Report, Injection Flow Rate section, 95 – 99.5% of the injection flow will be extracted. Furthermore, the production zone groundwater fortified with sulfuric acid and oxygen will be injected into the well fields and recirculated (LVMC Technical Report, Injection Fluid Composition section). Because the BC aquifer may not contain enough water supply, water from the adjacent BC or underlying N aquifer will be injected.

To operate the ISR, the BC aquifer needs to be saturated and therefore, would not be beneficial to have drawdown. Because the BC aquifer may not contain enough water supply, water from the adjacent BC or underlying N aquifer will be utilized.

After initial bonding estimates were evaluated, DWQ agreed that the estimates were lower than potentially expected. The company used a third party to evaluate and the \$4.5 million for the first three years was provided.

DWQ is not authorized to regulate water withdrawals and allocations. DWQ evaluates and regulates the implications of dischargers on water quality. The Division of Water Rights handles apportioning.

97. Comment

Dusty, This is my comment for the LVMC, UIC and Aquifer Exemption Permitting process. It was Great to meet you at the Hearing! My wife and I would like to formally invite you, Erica Gaddis, John Mackey, and Steve Earley out to Lisbon Valley before the final decision is made. We would sure appreciate, and be honored to have you all come out so that we can show you around the valley. It would sure be refreshing to have some honest, open, human interaction from both sides of the issue! Please let us know when a good time would be for this to happen! Thanks a Million for your consideration! Scott and Julie Stevenson

DWQ Response

Thank you for your comment.

98. Comment

*Respectfully submitted,
Karla J. VanderZanden*

TO: Drummond Earley UIC Program Utah Division of Water Quality P.O. Box 144870 Salt Lake City, UT 84114 dearley@utah.gov

RE: Public comment, second notice, on DWQ Intent to Issue Permit for the Lisbon Valley Mining Company (LVMC)- Underground Injection Control Class III Area Permit, In Situ Copper Recovery

I am familiar with the Lisbon Valley area and extensive historic and current mining activities. Together with guest scholars, I have designed and led adult geology and history field trips in this region. I have lived in the area since 1980 and am the founder of Canyonlands Field Institute, a non profit outdoor education organization.

I have read the Public Notice and associated documents that describe the proposed new in-situ copper recovery method outlined by LVMC and the revised application for 1) Aquifer Exemption Request and 2) Financial Assurance Mechanism. The aquifer proposed to be impacted is the "BC" Burro Canyon and Dakota sandstone formations.

I have followed the copper mine's activities and financial challenges through newspapers and public record over many years. I am familiar with the Wilcox ranching operation and commercial Three Step Bed & Breakfast located downslope, to the south of the proposed in-situ operation. Both operations are on historic properties with evidence of ancient human activity spanning over a thousand years. I have stayed at Three-Step with our seminar clients.

In the third party financial assurance analyses prepared by consultant firm Clear Creek Associates, the author states "The BC aquifer water quality is poor, and according to the LVMC application, there are no registered residential, municipal, or other commercial water wells in the BC aquifer within the Project area other than those owned by LVMC." This report does not acknowledge the existence of the Ranch and commercial B & B just a few miles away and clearly down hill from the proposed new mining activity. These properties draw from the same aquifer, using wells and springs.

Please record my opposition to both the Aquifer Exemption and Financial Assurance Mechanism. I am opposed to the approval the Issuance of a Permit due to impacts to an aquifer that is essential for neighboring human, livestock and wildlife consumption, for growing food and established agricultural and commercial hospitality businesses that meet financial and regulatory obligations.

The Clear Creek report provides a revised reclamation and closure cost but does not mention significant back property taxes owed to San Juan County. Though LVMC promises jobs and future tax revenues, has not performed responsibly thus far and allowing this company to expand operations poses unacceptable risks, both to the county, state and to the watershed.

DWQ Response

Please see response to comment number 62.

99. Comment

Hello Drummond Earley, We have been learning about mining in San Juan County for the past few weeks and I wanted to share our students' perspective about the mining decision for the Lisbon Valley Mining In Situ Expansion proposal. As teachers we tried to provide an unbiased platform. We used articles over the last two years that deal with the debate and public information on In Situ and water rights to help them form their opinions. Their letters are both for and against, however out of 50 students 70% are against the expansion in favor of protecting our water resource. I thought it might help the debate to see what some of our students think about this issue. ----- I think you should vote for the Lisbon Valley Copper Mines expansion to In Situ mining. My reasons are the following In Situ is cheaper. They said that they are going to clean up when their done. Also make it cleaner then it was before. 65 or more people will have jobs, San Juan is the most poor country. So the job will help a lot of people. It will help them for a while because the job goes till 2045 and it's a well paid job. That's why I think you should vote for the Lisbon Valley Copper Mines expansion to In Situ mining. ----- Dear County Commissioners I think you should vote for the Lisbon Valley Copper Mines expansion to In Situ mining. My reasons are the following, It is much cheaper and our county is

poor so it will save and gain more money, and it will open up jobs for people. (which has become more important due to the covid 19 pandemic) It is estimated that this would provide jobs until 2045 and will make a profit of about \$6 million. (Then they can pay their taxes) They also said that it would end up making our water cleaner because it already has bad oils and gasses in it. -----
----- They should be able to make the mine. There is only two people leaving on that ranch. It would be more support to have the mine for more of the people. If this mine did happen it would help more of the community long term. And it's not like they are using more and more water. They will recycle them and so they don't have to use a lot of extra water. And then we would get way more copper in return to make more of our everyday needs. -Bostyn Black ----
----- Yes they should be able to fo the in situ mining because they are innovating and making a more cost effective way to drill out copper. The new way they are proposing a new method which could be a better way and being more efficient and could be better for the environment and may be better than all the other process This is better for the economy and brings new jobs and will money back into San Juan county. So you may here that they have debt and this is a result in there being to profit from mining. ----- I am in favor of allowing in situ for the copper mines proposal. Because It helps people struggling without a job to get one because if it it passed it gives more jobs for people to do. And if it is done it has a high success rate for long term sustainability until maybe as estimated 2045. And it will 041 help the water be more cleaner, even though we may have even less water then we already do the benefit for long term are really great and for sure outweighs the cons. And in the long run this can be really great for our county and everyone that lives here. And yes there will be some sacrifices but eventually it will pay off. -Elijah Pena ----- There are lots of reasons to have this new way of in-situ mining, and there are lots of reasons not to. I think that if this was insured to work, then I would be for it. It is going to give a lot of people jobs, and it is going to make a lot of money. Our economy needs the money, and so do the people in this community. There will be less scarring to the surface of the planet and supposedly, it will leave the aquifer cleaner than it started. It is more cost-effective, and if it worked, would make us almost \$2,000,000,000.00. But, there is a lot to lose too. We live in a desert, there is no doubt about it. We have very little water, to begin with, and we have a lot to lose. This community depends a lot on agriculture, and the water to do so. We use water to nourish animals, plants, and ourselves as people. We have used our knowledge to get as much out of the Earth as we can, but also leave it as clean as possible. Thing is, there are a lot of things that make me think that this could go wrong. There have been multiple occasions with mines where the mess that has been made wasn't cleaned. The earth has been blown into, and when the mine was stripped down to nothing, it was just left there. With that information, how do we know that this mess will be cleaned up once it is all said and done? The Lisbon Valley company has been trying this for years now. They have been fighting for water rights and for the vote of the county commissioner to do this. But The Lisbon Valley Mine hasn't been paying their taxes to San Juan County. In fact, they have almost 1.4 million dollars in debt, because they have not been making a profit. Do we trust a company that can't even pay its own taxes to pay for this project? We don't even know if this will work, the only time

we have ever done this is with Uranium and Potash. But never with Copper. If this fails, then this county loses a lot. Water, money, time, and trust. Not only that but some people are living off of this water. Specifically, the Wilcox's, who are using this water for their farm. They need this water for their animals and crops, and themselves too. Respectfully, they aren't going to be giving up their water rights anytime too. As someone who doesn't own any land, I think that the cons of this project wouldn't affect me that much. After all, I am only a freshman in high school. But for someone who is using the water to make a living for themselves, their family, and the future generations. In conclusion, I do not think that we should be trying this new in-situ mining method. At least not until we are sure that it will work, we are sure that it will end well after 26 years, and we will be left with clean water. Because in reality, that's is what's most important to the people in San Juan County, water. Copper might be important, but we need water. Written by Gwen Behunin. ----- After reviewing the data and looking at the benefits and the disadvantages, I believe that they should not be able to use the In Situ mining. Although there are fairly good benefits to this type of mining, the costs are just too high. San Juan County doesn't have much going for it, and I understand why some people might want to give this mining a try but we don't have that much we can use to gamble with. I mean that in a metaphorical state. Utah as a whole doesn't have very much water and San Juan County is not an exception. This type of mining could greatly affect our water. It could pollute the little water we do have and that wouldn't help us out very much. Another thing you have to consider is the fact that this technique has never been used before. The possibility that this could go wrong is only 50%, but if you ask me that's around 25% too high. The final thing I would like you to acknowledge is that when we run out of copper in about 60 years, the mess of these mines will remain. On the contrary to this concern is that these mines will cause less surface scaring. This mining could also end with us having a cleaner aquifer. Overall, I think it would be better if we didn't take the 50% chance that this won't work. - Sincerely, Harleigh Laws ----- Water is one of our most precious and scarce resources. We're in the middle of one of our most awful droughts ever. If we let this mine run, we will contaminate our most precious and scarce resource. Sure, they say they can clean it up after they're done, but none of us can see the future. What if they 041 can't clean it up? What if this water is gone forever? We have no guarantee that this will work. I think that we just need to play it safe, and protect our water. -----

----- I am with the ranchers on this one. There are a lot of people in Blanding that have cattle and I think that if they had cows up there, they wouldn't want their water to be contaminated. I think that they should hold off on doing this type of mining until later years where we have a solution so it won't contaminate any water. In conclusion, I think we should hold off on doing this type of mining. -Cutler Baker, Blanding, Utah ----- I think that they should not do this. I think that if they do this than they will ruin the drinking water. If the drinking water gets ruined then we will be in big trouble because we are already in a drought so it will only hurt us. I think that this is a bad thing for ranchers too because they wont be able to water their crops or give their cattle water. -Brody Bilbao ----- Even though the copper mines would bring more jobs, they are ruining all of the counties ranchers, farmers, and

*pretty much anyone who needs waters' chances for continuing their business. We do not have much water as it is and if they take 2700 wells and take water from that then it will not help at all with the water situation. Though we are the poorest county in utah and this would get our profit percentage up, the money still would only go to the Lisbon Valley mine and not the rest of the county. - Rigley La Giglia Blanding, Utah ----- Personally, I don't think that the copper mine proposal is a good idea. One reason for this is because doing this there would be a risk of having our water contaminated. Another reason is that water is already scarce in our area. Overall, this is just not a good idea. It would ruin our drinking water for livestock, businesses, and our homes. Another thing is they aren't very trustworthy. This is because they have a ton of debt from unpaid taxes so it wouldn't be a good idea to have untrustworthy people doing this. There are some benefits for this copper mine happening like giving more jobs to the community or potentially ending with a cleaner aquifer which would be good. I just think that there are more negative outcomes from this than positive ones. -----
----- I think that it would be nice to have more jobs and money but I do not think they should be able to mine it. We need that water for those ranchers and their animals. We are also living in a desert and water is really valuable to us. I don't think we should waste it when we could be using it for better things. San Juan is one of the poorest counties and I think that it will be good for us to have more jobs but will it be worth it? The company claims that they will pick up the mess after but we don't know if we can trust that. The company is 1.4 million dollars in debt because they haven't paid their taxes. So I don't think we should trust a company that we can't even trust to pay their taxes. Overall I don't think we should let them mine because we need that water for us, the ranchers, and their animals. - Reagan Laws ----- I think that they should base it on what the mine does/did. Even though the mine said that they will clean it up after they aren't very trustworthy, they have unpaid taxes of \$1.4 million. So that shows that they have been trust worthy with their money but didn't do what was required. They also said that in the end it could end up being beneficial for the water and environment in the end, but what about the now? What they will be destroying or ruining for the time is water. 041 Water is a very important resource in the whole world, and is a lot harder to find here in San Juan. While we are in this drought right now it can harm all of the people and families for water resources. The 2 businesses that will be affected would loose needed money. -----
----- Dear County Commissioners, I think you should vote against the Lisbon Valley Copper Mines expansion to In Situ mining. My reasons are the following. The Lisbon Valley Copper Mines are in a 1.4 million dept, going at that they were unlawful and untrustworthy. You shouldn't but very much trust in them or the people that they got information from because they are untrustworthy. They say that they should make 4.5million-6.2 billion dollars off of this copper mine. But if you really do that math, you can get 500 million pounds of copper, and times that by 4 (4 dollars per pound of copper) you will get 2 billion dollars, not 6.2. Im not sure where they got 6.2 but this isn't even counting the cost of the labor and the equipment. This is an economic risk, social, and most of all environmental risk. Me being in a family of farmers and ranchers, that rely heavily on our wells, and under ground water, fear that this acid will pollute our drinking, and*

irrigating water. This could ruin livelihoods! They may say that they will clean it up or make sure it doesn't spread but they know as well as us we don't have much control of the water underground. Underground water, takes a extremely long time to replenish and our ground water is already very scarce. We should not risk losing the water that we have left. Farmers and ranches can't wait 20 years to get water and feed their animals, until they supposedly clean it up. This is why I think that you should vote against the Lisbon Valley Copper Mine -----

----- Dear county commissioners. I Am Spencer Gosney, a resident of San Juan county. It is my opinion that you should vote against the lisbon valley copper companies request to begin their in situ mining operation in the aquaphor. I believe that the economic growth and prosperity of San Juan county is indeed a goal worth pursuing, and that copper mining makes both jobs and profit. However, I also believe that the fact that the local ranchers and their businesses may be harmed, should sway your decision. If the mineis created, there is a good chance that their businesses will, at the very least, become less profitable due to water pollutants. Which is counter intuitive to the very nature of this project, which is to create more business and increase the credibility of the county. It is true that copper mining is a more lucrative business than ranching, or a bed and breakfast, but these businesses where here long before the copper mine was discovered. To risk hurting them, even if it meant greater profit, would once again be counter intuitive towards the real goal here. If you want to make San Juan county a better place, don't change it, grow it. If a copper mining operation was suggested that had almost no chance of harming an already existing business, than the path forward would obviously be to start mining. That is growing the county, where is hurting pre-existing businesses to create a new one is changing the county, and hurting it in the process. Unless the Lisbon valley copper company can provide more solid evidence that they will indeed make up for any environmental damage, and aid any businesses harmed by their endeavor, that their claim should be denied. Sincerely, Spencer Gosney -----

Dear County Commissioners, I think you should vote against the Lisbon Valley Copper Mine's expansion to In Situ mining. My reasons are the following; First, In Situ mining contaminates the groundwater. Although people may not be using that specific groundwater, water is a precious resource. As I'm sure you're aware, we live in a desert, and we are in a constant drought. Having enough water is a constant problem for this county. We shouldn't be throwing away the water we do have. It takes a long time for groundwater to replenish. It would be irresponsible to put acid in the good groundwater we already have, especially when it could be used for much better purposes. Second, the Lisbon Valley Copper Mine may not stand true to their word. They have not paid their property taxes for five years, which taxes, in total, equal \$1.4 million. This shows that they are untrustworthy, and kind of (if not very) illegal. Sure, they say they'll clean up when the copper is gone and the mine closes down, but how can you be sure? Will they stay true to their word? Or will a big mess be left behind, as has happened with many other mines? 041 Lastly, it can harm other people. Yes, there aren't very many people it will affect. But these people still matter. They use that water for drinking, watering their livestock, and their homes and businesses. It doesn't matter that the mine says they will monitor the groundwater and make sure it doesn't affect past where it is supposed to affect.

Anything could happen, and there are far too many ifs. It is unfair to them to tell them that their water is being put in danger, and that they'll have to just live with it. We need to be aware of these people, and aware of what could happen if the Lisbon Valley mine starts In Situ mining. - Ella Davis

Dear County Commissioners, I think you should vote against the Lisbon Valley Copper Mines expansion to the Situ mining. I think this because it could really affect our water by polluting it. Even if they say they will try to contain the Situ mining it will be very hard for them to do so because we don't really know much about the water underground. Also It will affect the ranchers around the mine a lot. It could kill their livestock and contaminate their water. The Situ Mining could cause those ranches to go bankrupt and out of commision. Also even if they say they will clean the water afterwards what are the odds they actually do? We already know they aren't trustworthy because they owe 1.4 million dollars in taxes. This shows me that they can say they will do something and not do it. The mess will be left behind after the mine is gone. In conclusion these are reasons that I think the Situ mining will cause a lot of damage. - Traken Lee Thank you for considering their perspectives. Jamie Carling Science Teacher San Juan High School Education is not the learning of facts, but the training of the mind to think. - Albert Einstein

DWQ Response

Thank you for your comment.

100. Comment

DWQ Response